

termok8[®]

catalogo



sistema specializzato di isolamento termico, risanamento e qualificazione energetica
specialized thermal insulation, renovation, and energy qualification system
sistema especializado de aislamiento térmico, renovación y calificación energética



Isolamento a cappotto: i vantaggi di una scelta sicura / external thermal insulation: the benefits of a safe choice / aislamiento térmico: las ventajas de elegir certezas	4
vantaggi abitativi / benefits for occupants / ventajas en calidad de vivienda	4
vantaggi prestazionali / performance benefits / ventajas de rendimiento	4
vantaggi economici / financial benefits / ventajas económicas	4
vantaggi ambientali / environmental benefits / ventajas para el medio ambiente	4
Quadro normativo italiano di riferimento del cappotto / Italian Regulatory Framework for External Thermal Insulation Systems / Marco normativo italiano de referencia para el sistema de aislamiento térmico exterior	8
UNI/TR 11715:2018	8
Guida alla scelta dei Sistemi di Isolamento Termico a Cappotto di qualità / Guide to choosing high-quality external thermal insulation systems / Guía para elegir Sistemas de Aislamiento Térmico Exterior de Calidad	12
attestazione di conformità, marcatura CE e kit / conformity attestation, CE marking and Kit / declaración de conformidad, marcado CE y kit	12
Un approccio virtuoso per il futuro / A virtuous approach for the future / Un enfoque virtuoso para el futuro	14
lastre isolanti per l'edilizia / insulation panels for construction / paneles aislantes para la construcción	15
ivas - unico produttore italiano di kit a km 0 / ivas - the only italian producer of zero-km insulation kits / ivas - único productor italiano de kits a km 0	16
con ivas nasce la green building valley / with ivas, the green building valley is born / con ivas nace la green building valley	16
Termok8: l'eccellenza nell'isolamento termico che soddisfa ogni esigenza / Termok8: the excellence in thermal insulation that meets every need / Termok8: la excelencia en aislamiento térmico que satisface todas las necesidades	18
tipologie di isolanti / types of insulation / tipos de aislantes	22
prestazione acustica / acoustic performance / prestaciones acústicas	24
comportamento acustico delle facciate / acoustic behaviour of façades / comportamiento acústico de las fachadas	24
funzionamento acustico di un sistema a cappotto / acoustic functioning of an external thermal insulation system / funcionamiento acústico de un sistema de aislamiento térmico	25
la soluzione IVAS / the IVAS solution / la solución IVAS	27
l'applicazione del sistema cappotto / application of the external thermal insulation system / la aplicación de un sistema de aislamiento térmico	30
posa dei profili di protezione e contenimento / application of protection and containment profiles / colocación de perfiles de protección y contención	30
posa dello strato isolante / application of the insulation layer / colocación de la capa aislante	31
strato d'isolante rinforzato / reinforced insulation layer / capa de aislamiento reforzado	34
fissaggio meccanico dello strato isolante / mechanical anchoring of the insulation layer / fijación mecánica de la capa aislante	35
protezione e rinforzo dello strato isolante / protection and reinforcement of the insulation layer / protección y refuerzo de la capa aislante	38
intonaco sottile armato / reinforced thin plaster / enfoscado fino armado	39
protezione del sistema / protection of the system / protección del sistema	39
rivestimento di finitura / finishing coat / revestimiento de acabado	40
termok8 design	44
texture design	44
modular design	45
i sistemi / the systems / los sistemas	46
la scelta del sistema cappotto / choosing the external thermal insulation system / la elección del sistema de aislamiento térmico	48
prestazioni termiche e acustiche / thermal and acoustic performance / prestaciones térmicas y acústicas	52
prestazioni meccaniche / mechanical performance / prestaciones mecánicas	55
best performance $\lambda < 30$ / best performance $\lambda < 30$ / best performance $\lambda < 30$	56
bioedilizia & minerali / green building & minerals / ecoarquitectura & minerales	57
finiture modulari / modular finishes / acabados modulares	60
i prodotti / the products / los productos	76
collanti e rasanti / adhesives and skim coats / colas y morteros de enrasado	76
collanti e rasanti ht / ht adhesives and skim coats / colas y morteros de enrasado ht	78
collanti fuganti per modulari / adhesives and grouts for modular systems / colas de rejuntado para modulares	83
isolanti eps riciclato / insulation recycled eps / aislantes eps reciclado	85
isolanti eps riciclato sintolaminato / insulation recycled eps produced by lamination synthesis / aislantes eps reciclado sintolaminado	93
isolanti eps fibre minerali / insulation mineral fibres / aislantes fibras minerales	94
isolanti prodotti speciali / insulation special products / aislantes productos especiales	96
tasselli ht / ht anchors / tacos ht	99
tasselli / anchors / tacos	102
accessori ht / ht accessories / accesorios ht	105
accessori / accessories / accesorios	108
elementi di fissaggio / fastening elements / elementos de fijación	117
davanzali / window sills / alféizares	124
reti in fibra di vetro / glass fibre mesh / mallas en fibra de vidrio	125
finiture / topcoats / acabados	127
rivestimenti modulari / modular cladding / revestimientos modulares	135
decori e cornici / decorative pieces and cornices / decoraciones y cornisas	136
attrezzature / equipment / herramientas	137
formazione academy / Academy training / formación Academy	141
assicurazione / insurance / seguro	141
software di calcolo / calculating software / software de cálculo	144

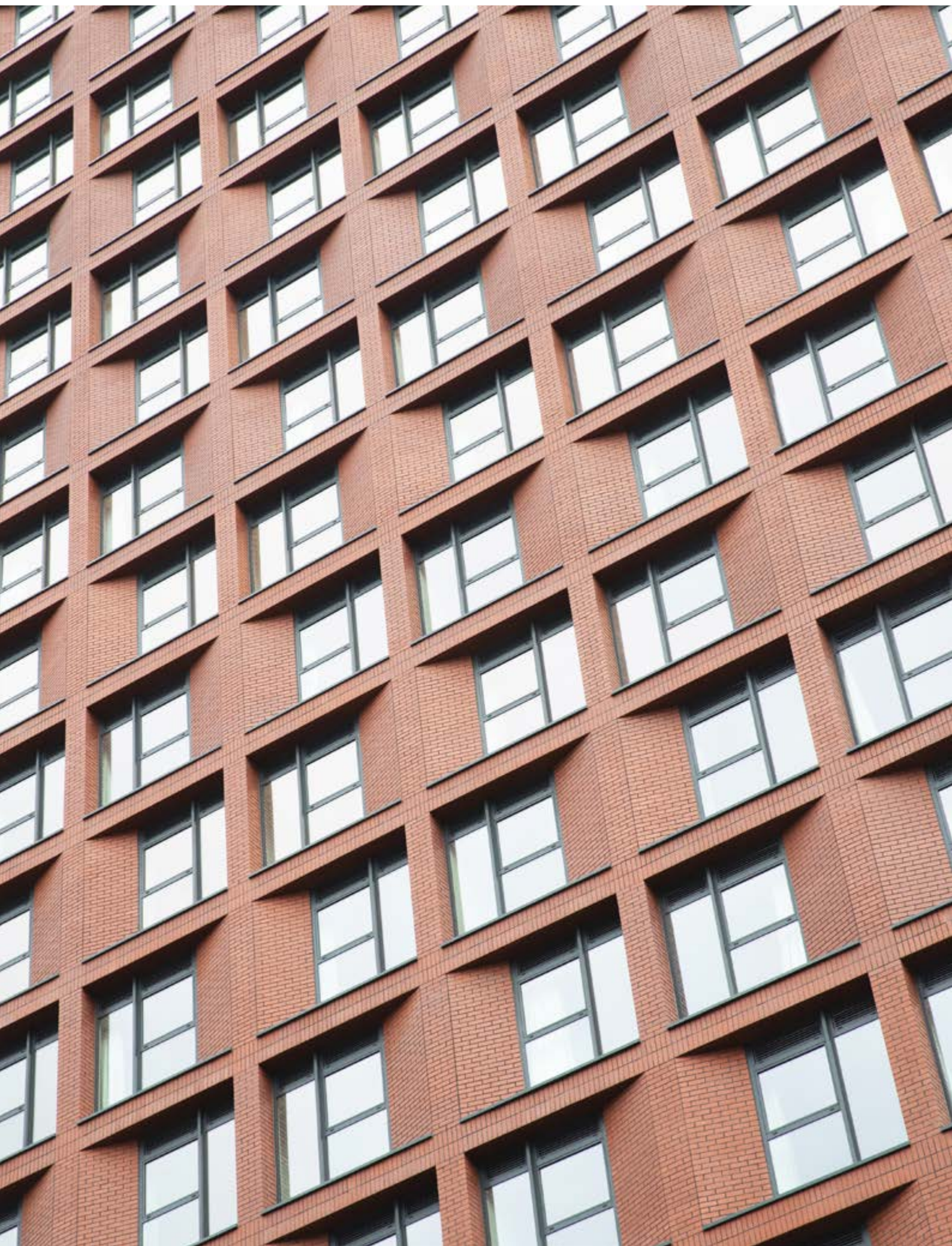

sistema specializzato
d'isolamento termico
risanamento e qualificazione
energetica

special thermal insulation,
renovation, and energy
qualification system

sistema especializado
de aislamiento térmico,
renovación y calificación
energética

Il Sistema a cappotto, denominato anche Sistema ETICS o più precisamente "Sistema composto di isolamento dall'esterno" è il sistema più usato in Europa per la coibentazione termica e in alcuni casi acustica, delle pareti verticali opache di edifici civili, industriali e terziari di nuova realizzazione e preesistenti.

Ivas produce da 40 anni la linea di sistemi a cappotto denominata termok8, composta da una vasta gamma di sistemi d'isolamento, specifici per differenti occasioni di risanamento e di qualificazione energetica.

E' Leader in Italia con oltre 35 milioni di metri quadrati applicati ad oggi su edifici di tutte le tipologie, in continua e costante sinergia con progettisti e imprese applicatrici.

Questo enorme patrimonio di realizzazioni, eseguite nelle condizioni climatiche più differenti e varie, ha generato un bagaglio di esperienza diretta in cantiere che difficilmente trova pari nel panorama nazionale.

termok8 assicura la trasmittanza ottimale di pareti, l'attenuazione dei ponti termici, la riduzione del fabbisogno di energia primaria, il massimo bilanciamento tra calorie esistenti, apportate e consumate, l'indice ottimale dei fattori di attenuazione termica e di sfasamento, per la più efficiente gestione energetica del sistema edificio.

The external thermal insulation system, also known as the ETICS system or more specifically the "External Thermal Insulation Composite System", is the most widely used system in Europe for thermal insulation, and in some cases sound insulation, of solid walls of new and existing residential, industrial, and commercial buildings.

For 40 years now, IVAS has been producing the line of external thermal insulation systems known as termok8, consisting of a wide range of insulation systems, specifically designed for various restoration and energy upgrading needs.

It is a market leader in Italy with over 35 million square metres installed to date on buildings of all types, continuously and constantly cooperating with both designers and installing companies.

This enormous record of achievements, undertaken in the most diverse climatic conditions, has produced a wealth of direct on-site experience that is virtually unmatched in Italy.

termok8 ensures optimal wall transmittance, reduced thermal bridges, reduced primary energy requirements, maximised balance between existing calories and those brought in and used, and an optimal thermal attenuation and time lag index, for more efficient building energy management.

El Sistema de aislamiento térmico, denominado también SATE o, más exactamente "Sistema compuesto de aislamiento del exterior" es el sistema más usado en Europa para el aislamiento térmico, y en algunos casos acústico, de las paredes verticales opacas de edificios civiles, industriales y terciarios de nueva construcción o ya existentes.

Ivas produce desde hace 40 años la línea de sistemas por capas denominada termok8, formada por una amplia gama de sistemas de aislamiento, específicos para distintos contextos de saneamiento y cualificación energética.

Es líder en Italia, con más de 35 millones de metros cuadrados aplicados hasta la fecha en toda clase de edificios, en continua y constante sinergia con proyectistas y empresas instaladoras.

Este enorme patrimonio de instalaciones, efectuadas en las condiciones climáticas más dispares y variadas, ha generado un bagaje de experiencia directa en obra que difícilmente encuentra parangón en el panorama italiano.

termok8 asegura la transmitancia ideal de las paredes, la atenuación de los puentes térmicos, la reducción del consumo de energía primaria, el máximo equilibrio entre calorías existentes, aportadas y consumidas, el índice ideal de los factores de atenuación y desfase térmicos, para la más eficiente gestión energética del sistema edificio.



IVAS è associata a
IVAS is associated with
IVAS está asociada a



isolamento a cappotto: i vantaggi di una scelta sicura

external thermal insulation: the benefits of a safe choice

aislamiento térmico: las ventajas de elegir con seguridad

vantaggi abitativi

- il comfort di un clima ideale (controllo di temperatura e umidità)
- il benessere di un ambiente sano (controllo di condense e muffe)
- la protezione acustica

vantaggi prestazionali

- l'efficacia della soluzione costruttiva più corretta per il migliore isolamento
- la semplicità nell'ottemperare alle normative in materia di efficienza energetica
- la protezione che assicura buona e lunga vita al fabbricato
- lo spazio abitativo risparmiato rispetto ad altre tipologie di isolamento
- l'efficacia e la convenienza come ciclo di ripristino

vantaggi economici

- la drastica riduzione dei consumi per la climatizzazione (caldo, freddo)
- l'aumento della classe energetica dell'edificio
- l'aumento del valore dell'immobile
- la possibilità di accedere a incentivi, agevolazioni fiscali e deroghe a normative edilizie

vantaggi ambientali

- il considerevole risparmio energetico
- la sostanziale riduzione d'immissioni ad effetto serra
- il contributo al contenimento del riscaldamento planetario
- la riduzione dello sfruttamento delle risorse fossili

benefits for occupants

- the comfort of an ideal environment (temperature and humidity control)
- the health benefits of a wholesome environment (control of condensation and mould)
- sound insulation

performance benefits

- effectiveness of the building method most appropriate for the best insulation
- ease of meeting energy efficiency standards
- protection that guarantees the building a long and healthy life
- living space saved compared to other types of insulation
- effectiveness and convenience as a renovation process

financial benefits

- drastic reduction in energy consumption for air conditioning (heat, cold)
- improvement in the building's energy class
- increased property value
- eligibility for incentives, tax allowances and building regulation exemptions

environmental benefits

- considerable energy savings
- substantial reduction in greenhouse gas emissions
- contribution to reducing global warming
- reducing the consumption of fossil fuel resources

ventajas en calidad de vivienda

- la comodidad de un clima ideal (control de temperatura y humedad)
- el bienestar de un ambiente sano (control de condensaciones y mohos)
- la protección acústica

ventajas de rendimiento

- la eficacia de la solución de construcción más correcta para el mejor aislamiento
- la simplicidad a la hora de cumplir con las normativas en materia de eficiencia energética
- la protección que asegura al edificio una larga vida en las mejores condiciones
- con respecto a otras soluciones, se recupera espacio de vivienda
- la eficacia y conveniencia como proceso de renovación

ventajas económicas

- la drástica reducción del consumo en climatización (calor, frío)
- el aumento de la clase energética del edificio
- el aumento del valor del inmueble
- la posibilidad de acceder a incentivos, facilidades fiscales y excepciones a normativas de construcción

ventajas para el medio ambiente

- el considerable ahorro energético
- la sustancial reducción de emisiones de efecto invernadero
- la contribución a reducir el calentamiento global
- la reducción de la explotación de recursos fósiles

termok8 è la soluzione più efficace per garantire con semplicità il rispetto degli standard in materia di efficienza energetica, tanto in fase di costruzione quanto in ristrutturazione. Con spessori isolanti adeguati, assicura drastiche riduzioni del calore dissipato all'esterno, un risparmio energetico consistente e costante, una riduzione del consumo di combustibili (e relative emissioni inquinanti) dal 40% al 60%, garantendo, con semplicità ed efficacia, l'eliminazione dei ponti termici.

termok8 is the most effective and simple solution for ensuring compliance with energy efficiency standards, both during new construction and renovation. Using suitable thicknesses of insulation, it results in drastic reductions in the heat lost to outside air, substantial ongoing energy savings, and a reduction in fuel consumption (and related pollutant emissions) of between 40% and 60%, simply and effectively ensuring the elimination of thermal bridges.

termok8 es la solución más simple y eficaz para garantizar el cumplimiento de los estándares de eficiencia energética, tanto en fase de construcción como en caso de acondicionamiento. Con los espesores de aislante adecuados, asegura drásticas reducciones del calor dissipado al exterior, un ahorro energético consistente y constante y una reducción del consumo de combustibles (y de sus emisiones contaminantes) entre el 40% y el 60%, garantizando, con sencillez y eficacia, la eliminación de los puentes térmicos.

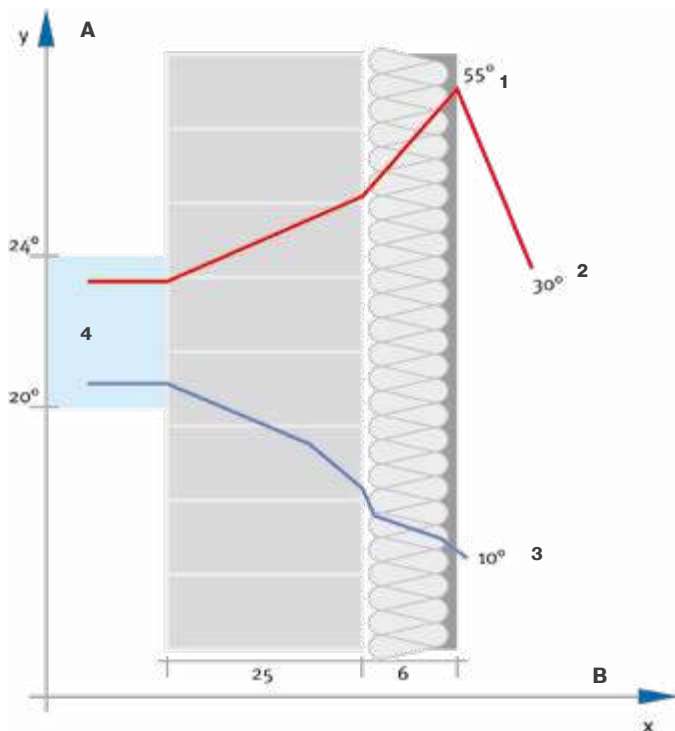

- A. temperatura interna
- B. spessore della parete
- 1. temperatura irraggiamento
- 2. temperatura esterna estiva
- 3. temperatura esterna invernale
- 4. temperatura di comfort ideale

- A. indoor temperature
- B. wall thickness
- 1. radiant temperature
- 2. outdoor summer temperature
- 3. outdoor winter temperature
- 4. ideal comfortable temperature

- A. temperatura interna
- B. espesor de la pared
- 1. temperatura de irradiación
- 2. temperatura externa en verano
- 3. temperatura externa en invierno
- 4. temperatura ideal para la comodidad

termok8 previene la formazione di muffe e condense interne, regola i parametri fondamentali (rapporto tra umidità relativa e temperatura ambiente) per l'ottenimento di un comfort abitativo ideale e assicura alle murature una protezione termo-igrometrica che risolve o previene tutte le patologie causate da dilatazioni e ritiri termici diversi tra le strutture e i tamponamenti.

termok8 prevents the formation of indoor mould and condensation, regulates the basic parameters (the relationship between relative humidity and room temperature) to produce perfect living conditions, and provides temperature and humidity protection for masonry, solving or preventing any defects caused by differing thermal expansion and contraction rates between structural elements and infill.

termok8 previene la formación de mohos y condensación interna, regula los parámetros fundamentales (relación entre la humedad relativa y la temperatura ambiente) para obtener una comodidad ideal en la vivienda y asegura a las paredes una protección termo-higrométrica que resuelve o previene todas las patologías causadas por las diferentes dilataciones y retracciones térmicas entre las estructuras y los materiales de relleno.

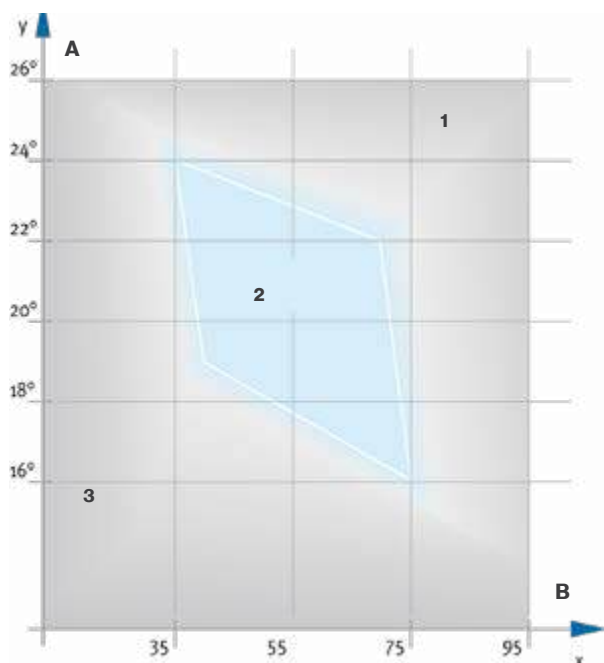

- A. temperatura interna
- B. % umidità relativa interna
- 1. malessere per alta umidità
- 2. rapporto ideale temperatura / umidità interna
- 3. malessere per bassa umidità

- A. indoor temperature
- B. wall thickness
- 1. radiant temperature
- 2. temperatura esterna estiva
- 3. temperatura esterna invernale

- A. temperatura interna
- B. % humedad relativa interna
- 1. malestar por alto nivel de humedad
- 2. relación ideal temperatura / humedad interna
- 3. malestar por bajo nivel de humedad



la termografia è una tecnica d'indagine non invasiva che, attraverso l'immagine dei corpi ad infrarossi, visualizza i punti di maggiore dispersione del calore

thermography is a non-invasive investigation technique that uses infrared imagery to visualise the points of greatest heat loss from solid bodies

la termografía es una técnica de estudio no invasiva que, a través de la imagen a infrarrojos de los cuerpos, visualiza los puntos de mayor dispersión del calor

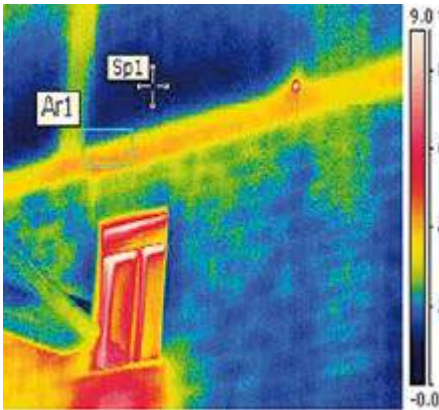

prima dell'applicazione termok8 (scala di temperatura 0°/9° C): ponti termici e dispersioni in corrispondenza degli elementi riscaldanti interni

before applying termok8 (temperature scale: from 0° to 9° C): thermal bridges and heat loss from internal heating elements

antes de aplicar termok8 (escala de temperatura 0/9°C): puentes térmicos y dispersiones en correspondencia con los elementos calefactores internos

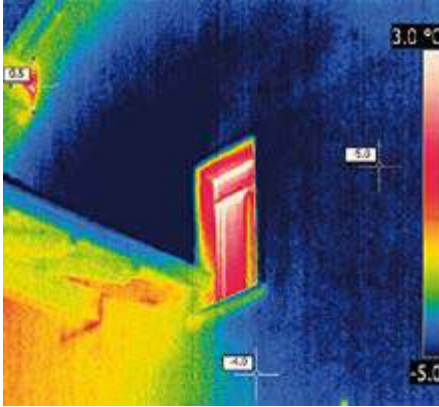

dopo l'applicazione termok8 (scala di temperatura -5°/+3° C) è evidente la correzione continua dei ponti termici presenti in parete

after applying termok8 (temperature scale: from -5° to +3° C): a more sensitive scale is needed to demonstrate minimal heat loss

después de aplicar termok8 (escala de temperatura -5/+3°C): para notar dispersiones térmicas mínimas se necesita una escala más sensible



si ringrazia ARPA Valle d'Aosta per la gentile concessione delle indagini termografiche

we would like to thank ARPA Valle d'Aosta for kindly providing the thermographic surveys

se agradece a ARPA Valle d'Aosta por su amabilidad al darnos acceso a los estudios termográficos



Quadro normativo italiano di riferimento del cappotto

Italian Regulatory Framework for External Thermal Insulation Systems

Marco normativo italiano de referencia para el sistema de aislamiento térmico exterior (SATE)

UNI/TR 11715:2018

"Linee guida per la progettazione e la messa in opera di sistemi compositi di isolamento termico per esterno (ETICS)"

La norma UNI/TR 11715: 2018 fornisce indicazioni dettagliate e raccomandazioni per la corretta progettazione e installazione dei sistemi compositi di isolamento termico per esterno, comunemente noti come ETICS (External Thermal Insulation Composite Systems). Questi sistemi sono utilizzati per migliorare l'efficienza energetica degli edifici, riducendo la dispersione di calore attraverso le pareti esterne.

CONTENUTI PRINCIPALI:

Introduzione

- Scopo e campo di applicazione della norma.
- Definizioni dei termini tecnici utilizzati nel contesto dei sistemi ETICS.
- Progettazione del Sistema ETICS
- Analisi preliminare: Valutazione delle condizioni dell'edificio esistente, identificazione dei materiali e delle tecnologie più idonee.
- Scelta dei materiali: Selezione degli isolanti termici, adesivi, armature, intonaci di finitura e altri componenti.
- Progettazione dei dettagli costruttivi: Indicazioni su come progettare giunti, angoli, raccordi e altre parti critiche per evitare ponti termici e garantire la continuità dell'isolamento.
- Preparazione del Supporto.
- Valutazione e preparazione delle superfici su cui sarà applicato il sistema ETICS.
- Riparazione e livellamento delle superfici, se necessario, per garantire l'adesione ottimale del sistema.
- Messa in Opera del Sistema ETICS.
- Applicazione degli strati di isolamento: Linee guida per l'applicazione degli strati di isolante termico, adesivo e rete di armatura.
- Fissaggio: Metodi di fissaggio meccanico o adesivo per garantire la stabilità e la durabilità del sistema.
- Intonaci di finitura: Applicazione degli strati di finitura per proteggere l'isolamento e migliorare l'estetica dell'edificio.
- Controllo di Qualità.
- Procedure per il controllo di qualità durante la messa in opera del sistema.
- Verifiche e test per assicurare la conformità del sistema ETICS alle specifiche progettuali e normative.
- Manutenzione e Durabilità.
- Indicazioni per la manutenzione periodica del sistema ETICS per garantirne la durabilità nel tempo.
- Raccomandazioni per la gestione delle riparazioni in caso di danni o degrado.

UNI/TR 11715:2018

"Guidelines for the design and installation of External Thermal Insulation Composite Systems (ETICS)"

The UNI/TR 11715:2018 standard provides detailed guidelines and recommendations for the correct design and installation of External Thermal Insulation Composite Systems (ETICS). These systems are used to improve the energy efficiency of buildings by reducing heat loss through external walls.

MAIN CONTENTS:

Introduction

- Purpose and scope of the standard.
- Definitions of technical terms used in the context of ETICS.
- Design of the ETICS System
- Preliminary analysis: Assessment of the existing building conditions, identification of the most suitable materials and technologies.
- Material selection: Selection of thermal panels insulation, adhesives, reinforcements, finishing plasters, and other components.
- Design of construction details: Guidelines on designing joints, corners, connections, and other critical parts to avoid thermal bridges and ensure insulation continuity.
- Preparation of the Support
- Assessment and preparation of the surfaces to which the ETICS system will be applied.
- Repair and levelling of surfaces, if necessary, to ensure optimal adhesion of the system.
- Installation of the ETICS System
- Application of insulation layers: Guidelines for the application of thermal insulation layers, adhesive, and reinforcement mesh.
- Fixing: Methods of mechanical or adhesive fixing to ensure the stability and durability of the system.
- Finishing plasters: Application of finishing layers to protect the insulation and enhance the building's aesthetics.
- Quality Control
- Procedures for quality control during the installation of the system.
- Inspections and tests to ensure the compliance of the ETICS system with design and regulatory specifications.
- Maintenance and Durability
- Guidelines for the periodic maintenance of the ETICS system to ensure its long-term durability.
- Recommendations for managing repairs in case of damage or deterioration.

UNI/TR 11715:2018

"Directrices para el diseño e instalación de sistemas compuestos de aislamiento térmico exterior (SATE)"

La norma UNI/TR 11715:2018 proporciona indicaciones detalladas y recomendaciones para el diseño e instalación correctos de los sistemas compuestos de aislamiento térmico exterior, comúnmente conocidos como SATE (Sistema de Aislamiento Térmico por el Exterior). Estos sistemas se utilizan para mejorar la eficiencia energética de los edificios, reduciendo la pérdida de calor a través de las paredes exteriores.

CONTENIDOS PRINCIPALES:

Introducción

- Objetivo y ámbito de aplicación de la norma.
- Definiziones de los términos técnicos utilizados en el contexto de los sistemas SATE.
- Diseño del Sistema SATE
- Análisis preliminar: Evaluación de las condiciones del edificio existente, identificación de los materiales y tecnologías más adecuadas.
- Selección de materiales: Elección de los aislantes térmicos, adhesivos, refuerzos, revocos de acabado y otros componentes.
- Diseño de detalles constructivos: Indicaciones sobre cómo diseñar juntas, esquinas, conexiones y otras partes críticas para evitar puentes térmicos y garantizar la continuidad del aislamiento.
- Preparación del Soporte
- Evaluación y preparación de las superficies sobre las que se aplicará el sistema SATE.
- Reparación y nivelación de las superficies, si es necesario, para garantizar la adhesión óptima del sistema.
- Instalación del Sistema SATE
- Aplicación de las capas de aislamiento: Directrices para la aplicación de las capas de aislante térmico, adhesivo y malla de refuerzo.
- Fijación: Métodos de fijación mecánica o adhesiva para garantizar la estabilidad y durabilidad del sistema.
- Revocos de acabado: Aplicación de las capas de acabado para proteger el aislamiento y mejorar la estética del edificio.
- Control de Calidad
- Procedimientos para el control de calidad durante la instalación del sistema.
- Verificaciones y pruebas para asegurar la conformidad del sistema SATE con las especificaciones de diseño y normativas.
- Mantenimiento y Durabilidad
- Indicaciones para el mantenimiento periódico del sistema SATE para garantizar su durabilidad en el tiempo.
- Recomendaciones para la gestión de reparaciones en caso de daños o degradación.

Importanza della Norma UNI/TR 11715:2018

La norma **UNI/TR 11715:2018** è essenziale per:

- Progettisti e ingegneri: Fornisce una guida dettagliata per progettare sistemi ETICS efficienti e conformi alle normative vigenti.
- Installatori e costruttori: Offre istruzioni precise per la corretta messa in opera dei sistemi ETICS, riducendo il rischio di errori e migliorando la qualità dell'installazione.
- Proprietari di edifici e gestori: Fornisce informazioni utili sulla manutenzione e la durabilità dei sistemi ETICS, contribuendo a massimizzare l'investimento nel miglioramento dell'efficienza energetica degli edifici.

IN SINTESI, LA **UNI/TR 11715:2018** RAPPRESENTA UN PUNTO DI RIFERIMENTO FONDAMENTALE PER L'IMPLEMENTAZIONE DI SISTEMI DI ISOLAMENTO TERMICO PER ESTERNI, GARANTENDO EFFICIENZA ENERGETICA, COMFORT ABITATIVO E SOSTENIBILITÀ A LUNGO TERMINE.

Importance of UNI/TR 11715:2018

The **UNI/TR 11715:2018** standard is essential for:

- Designers and Engineers: Provides a detailed guide for designing efficient and compliant ETICS systems.
- Installers and Builders: Offers precise instructions for the correct installation of ETICS, reducing the risk of errors and improving installation quality.
- Building Owners and Managers: Provides useful information on the maintenance and durability of ETICS systems, helping to maximize investment in building energy efficiency improvements.

IN SUMMARY, **UNI/TR 11715:2018** REPRESENTS A FUNDAMENTAL REFERENCE POINT FOR THE IMPLEMENTATION OF EXTERNAL THERMAL INSULATION SYSTEMS, ENSURING ENERGY EFFICIENCY, LIVING COMFORT, AND LONG-TERM SUSTAINABILITY.

Importancia de la Norma UNI/TR 11715:2018

La norma **UNI/TR 11715:2018** es esencial para:

- Diseñadores e ingenieros: Proporciona una guía detallada para diseñar sistemas SATE eficientes y conformes con las normativas vigentes.
- Instaladores y constructores: Ofrece instrucciones precisas para la correcta instalación de los sistemas SATE, reduciendo el riesgo de errores y mejorando la calidad de la instalación.
- Propietarios de edificios y gestores: Proporciona información útil sobre el mantenimiento y la durabilidad de los sistemas SATE, contribuyendo a maximizar la inversión en la mejora de la eficiencia energética de los edificios.

EN RESUMEN, LA **UNI/TR 11715:2018** REPRESENTA UN PUNTO DE REFERENCIA FUNDAMENTAL PARA LA IMPLEMENTACIÓN DE SISTEMAS DE AISLAMIENTO TÉRMICO EXTERIOR, GARANTIZANDO EFICIENCIA ENERGÉTICA, CONFORT HABITACIONAL Y SOSTENIBILIDAD A LARGO PLAZO.

UNI/TR 11716:2018

UNI 11716:2018

Attività professionali non regolamentate - Figure professionali che eseguono la posa dei sistemi compositi di isolamento termico per esterno (ETICS) - Requisiti di conoscenza, abilità e competenza.

La norma UNI 11716:2018 definisce i requisiti di conoscenza, abilità e competenza per le figure professionali che eseguono la posa dei sistemi compositi di isolamento termico per esterno (ETICS). Questa norma è particolarmente importante in quanto mira a garantire la qualità dell'installazione e la competenza degli operatori coinvolti in queste attività non regolamentate.

CONTENUTI PRINCIPALI:

Scopo e Campo di Applicazione

- Scopo: Stabilire i requisiti minimi di conoscenza, abilità e competenza per i professionisti che si occupano dell'installazione dei sistemi ETICS.
- Campo di applicazione: La norma si applica a tutte le figure professionali coinvolte nella posa dei sistemi ETICS, indipendentemente dal tipo di rapporto di lavoro (dipendenti, autonomi, ecc.).

Figure Professionali Coinvolte

- Installatore di base: Professionista che esegue le attività operative di base relative alla posa dei sistemi ETICS.
- Caposquadra: Professionista con esperienza che coordina e supervisiona le attività degli installatori.
- Tecnico specializzato: Professionista con competenze avanzate che supporta la progettazione e la verifica dei sistemi ETICS.

Requisiti di Conoscenza

- Conoscenze generali: Nozioni di base sui materiali e sui componenti dei sistemi ETICS, principi di fisica edile e termotecnica, normativa tecnica e legislazione di riferimento.

Conoscenze specifiche: Dettagli sui processi di installazione, le tecniche di fissaggio, i metodi di con

UNI/TR 11716:2018

UNI 11716:2018

“Unregulated professional activities - Professional figures involved in the installation of External Thermal Insulation Composite Systems (ETICS) Requirements of knowledge, skills, and competence.”

The standard defines the knowledge, skills, and competence requirements for professionals involved in the installation of External Thermal Insulation Composite Systems (ETICS). This standard is particularly important as it aims to ensure the quality of installation and the competence of operators involved in these unregulated activities.

MAIN CONTENTS:

Purpose and Scope

- Purpose: Establish the minimum knowledge, skills, and competence requirements for professionals involved in ETICS installation.
- Scope: The standard applies to all professional figures involved in ETICS installation, regardless of their employment relationship (employees, self-employed, etc.).

Involved Professional Figures

- Basic Installer: A professional who performs the basic operational activities related to the installation of ETICS systems.
- Foreman: An experienced professional who coordinates and supervises the activities of the installers.
- Specialized Technician: A professional with advanced skills who supports the design and verification of ETICS systems.

Knowledge Requirements

- General Knowledge: Basic understanding of ETICS materials and components, building physics and thermal engineering principles, relevant technical standards, and legislation.
- Specific Knowledge: Details of installation processes, fixing techniques, quality control

UNI/TR 11716:2018

UNI 11716:2018

Actividades profesionales no reglamentadas - Figuras profesionales que ejecutan la instalación de sistemas de aislamiento térmico exterior (SATE) Requisitos de conocimiento, habilidades y competencias.

La norma UNI 11716:2018 define los requisitos de conocimiento, habilidades y competencias para las figuras profesionales que ejecutan la instalación de sistemas compuestos de aislamiento térmico exterior (SATE). Esta norma es particularmente importante ya que busca garantizar la calidad de la instalación y la competencia de los operadores involucrados en estas actividades no reglamentadas.

CONTENIDOS PRINCIPALES:

Objetivo y Ámbito de Aplicación

- Objetivo: Establecer los requisitos mínimos de conocimiento, habilidades y competencias para los profesionales que se dedican a la instalación de sistemas SATE.
- Ámbito de aplicación: La norma se aplica a todas las figuras profesionales involucradas en la instalación de sistemas SATE, independientemente del tipo de relación laboral (empleados, autónomos, etc.).

Figuras Profesionales Involucradas

- Instalador básico: Profesional que realiza las actividades operativas básicas relacionadas con la instalación de sistemas SATE.
- Jefe de equipo: Profesional con experiencia que coordina y supervisa las actividades de los instaladores.
- Técnico especializado: Profesional con competencias avanzadas que apoya en el diseño y la verificación de los sistemas SATE.

Requisitos de Conocimiento

- Conocimientos generales: Conceptos básicos sobre los materiales y componentes de los sistemas SATE, principios de física de la edificación y tecnología térmica, normativa técnica y legislación de referencia.
- Conocimientos específicos: Detalles sobre

controllo della qualità e le procedure di manutenzione.

Requisiti di Abilità

- Abilità tecniche: Capacità di preparare il supporto, applicare gli strati di isolamento, eseguire correttamente il fissaggio e applicare gli intonaci di finitura.
- Abilità operative: Capacità di utilizzare correttamente gli strumenti e le attrezzature specifiche per la posa dei sistemi ETICS.
- Abilità di coordinamento (per i capisquadra): Coordinamento delle attività di squadra, gestione delle risorse e risoluzione di problemi operativi.

Requisiti di Competenza

- Competenza professionale: Capacità di eseguire lavori di qualità, rispettando le specifiche tecniche e normative.
- Competenza comunicativa: Capacità di comunicare efficacemente con il team di lavoro, i progettisti e i committenti.
- Competenza gestionale (per i capisquadra e tecnici specializzati): Gestione dei progetti, pianificazione delle attività e supervisione delle operazioni di installazione.

Certificazione delle Competenze

- Valutazione delle competenze: Procedure per la valutazione e la certificazione delle competenze degli installatori, capisquadra e tecnici specializzati.
- Aggiornamento professionale: Indicazioni sulla formazione continua e l'aggiornamento delle competenze per mantenere elevati standard di qualità nel tempo.

methods, and maintenance procedures.

Skill Requirements

- Technical Skills: Ability to prepare the substrate, apply insulation layers, correctly execute fixing, and apply finishing plasters.
- Operational Skills: Ability to correctly use specific tools and equipment for ETICS installation.
- Coordination Skills (for Foremen): Coordination of team activities, resource management, and resolution of operational problems.

Competence Requirements

- Professional Competence: Ability to perform quality work in accordance with technical and regulatory specifications.
- Communication Competence: Ability to effectively communicate with the work team, designers, and clients.
- Management Competence (for Foremen and Specialized Technicians): Project management, activity planning, and supervision of installation operations.

Certification of Competencies

- Competency Evaluation: Procedures for the evaluation and certification of the competencies of installers, foremen, and specialized technicians.
- Professional Development: Guidelines for continuous training and skills updating to maintain high-quality standards over time.

los procesos de instalación, las técnicas de fijación, los métodos de control de calidad y los procedimientos de mantenimiento.

Requisitos de Habilidades

- Habilidades técnicas: Capacidad para preparar el soporte, aplicar las capas de aislamiento, realizar correctamente la fijación y aplicar los revocos de acabado.
- Habilidades operativas: Capacidad para utilizar correctamente las herramientas y equipos específicos para la instalación de sistemas SATE.
- Habilidades de coordinación (para los jefes de equipo): Coordinación de las actividades del equipo, gestión de recursos y resolución de problemas operativos.

Requisitos de Competencia

- Competencia profesional: Capacidad para realizar trabajos de calidad, respetando las especificaciones técnicas y normativas.
- Competencia comunicativa: Capacidad para comunicarse eficazmente con el equipo de trabajo, los diseñadores y los clientes.
- Competencia de gestión (para jefes de equipo y técnicos especializados): Gestión de proyectos, planificación de actividades y supervisión de las operaciones de instalación.

Certificación de Competencias

- Evaluación de competencias: Procedimientos para la evaluación y certificación de las competencias de los instaladores, jefes de equipo y técnicos especializados.
- Actualización profesional: Indicaciones sobre la formación continua y la actualización de competencias para mantener altos estándares de calidad a lo largo del tiempo.

Importanza della Norma UNI 11716:2018

La **UNI 11716:2018** è fondamentale per:

- Assicurare la Qualità: Garantisce che gli installatori di **sistemi ETICS** abbiano le competenze necessarie per eseguire lavori di alta qualità, contribuendo all'efficienza energetica degli edifici.
- Professionalizzare il Settore: Riconosce e definisce le competenze specifiche delle figure professionali, promuovendo la professionalizzazione del settore dell'isolamento termico.
- Proteggere i Consumatori: Assicura che i committenti possano affidarsi a professionisti qualificati, riducendo il rischio di lavori eseguiti in modo non corretto e migliorando la durabilità e le prestazioni dei sistemi di isolamento.

IN SINTESI, LA NORMA **UNI 11716:2018** RAPPRESENTA UN PASSO SIGNIFICATIVO VERSO LA STANDARDIZZAZIONE E IL MIGLIORAMENTO DELLA QUALITÀ DEI LAVORI DI INSTALLAZIONE DEI SISTEMI DI ISOLAMENTO TERMICO PER ESTERNO, ASSICURANDO CHE LE FIGURE PROFESSIONALI COINVOLTE ABBIANO LE COMPETENZE NECESSARIE PER OPERARE EFFICACEMENTE E IN CONFORMITÀ CON LE NORMATIVE VIGENTI.

LA MARCATURA CE

La marcatura CE per i prodotti da costruzione è regolata dal Regolamento UE 305/2011, applicato in Italia con il DLgs 106/2017.

I prodotti che devono avere la marcatura CE sono quelli per i quali esiste una norma armonizzata a livello europeo. Se non esiste tale norma, i prodotti possono ottenere la marcatura **CE** tramite una procedura volontaria nota come **ETA (European Technical Assessment)**, basata su un **EAD (European Assessment Document)** che definisce le prestazioni da valutare e le metodologie da utilizzare.

Un "prodotto da costruzione" può essere un singolo prodotto o un "kit", cioè un insieme di almeno due componenti che devono essere assemblati per l'installazione finale. Il cappotto termico è un esempio di kit. Attualmente, per i Sistemi a Cappotto non esiste una norma armonizzata specifica. Tuttavia, possono ottenere la marcatura CE su base volontaria facendo riferimento all'EAD 040083-00-0404. In Italia, molti sistemi a cappotto utilizzano ancora l'ETA basato su ETAG 004, ma dal 2021, i nuovi ETA devono basarsi sull'EAD 040083-00-0404.

La **marcatura CE** di un sistema a cappotto **assicura prestazioni e durata migliori**, poiché i **prodotti sono testati in laboratorio e garantiscono compatibilità tra i componenti**. Il produttore garantisce le prestazioni del sistema, rendendo consigliabile la scelta di un sistema **marcato CE**.

QUESTA RACCOMANDAZIONE È SUPPORTATA ANCHE DALLA NOTA ENEA SUI PANNELLI ISOLANTI (DICEMBRE 2020), CHE SPIEGA COME DICHIARARE LE PRESTAZIONI TERMICHE PER INTERVENTI CHE ACCEDONO A INCENTIVI FISCALI.

Importance of UNI 11716:2018

The **UNI 11716:2018** standard is crucial for:

- Ensuring Quality: It ensures that **ETICS installers** have the necessary competencies to perform high-quality work, contributing to building energy efficiency.
- Professionalizing the Sector: It recognizes and defines the specific competencies of professional figures, promoting the professionalization of the thermal insulation sector.
- Protecting Consumers: It ensures that clients can rely on qualified professionals, reducing the risk of improperly executed work and improving the durability and performance of insulation systems.

IN SUMMARY, THE **UNI 11716:2018** STANDARD REPRESENTS A SIGNIFICANT STEP TOWARDS THE STANDARDIZATION AND IMPROVEMENT OF THE QUALITY OF EXTERNAL THERMAL INSULATION SYSTEM INSTALLATIONS, ENSURING THAT THE INVOLVED PROFESSIONALS HAVE THE NECESSARY COMPETENCIES TO OPERATE EFFECTIVELY AND IN COMPLIANCE WITH CURRENT REGULATIONS.

CE MARKING CE

Marking for construction products is regulated by EU Regulation 305/2011, applied in Italy by Legislative Decree 106/2017.

Products requiring CE marking are those for which a harmonized European standard exists. If such a standard does not exist, products can obtain **CE** marking through a voluntary procedure known as **ETA (European Technical Assessment)**, based on an **EAD (European Assessment Document)** that defines the performance to be evaluated and the methodologies to be used.

A "construction product" can be a single product or a "kit," meaning a set of at least two components that need to be assembled for the final installation. External thermal insulation systems (ETICS) are an example of a kit. Currently, there is no specific harmonized standard for ETICS. However, they can obtain CE marking on a voluntary basis by referring to EAD 040083-00-0404. In Italy, many ETICS systems still use the ETA based on ETAG 004, but since 2021, new ETAs must be based on EAD 040083-00-0404.

The CE marking of an ETICS system **ensures better performance and durability**, as the products are laboratory-tested and **guarantee compatibility between components**. The manufacturer guarantees the system's performance, making it advisable to choose a CE-marked system.

THIS RECOMMENDATION IS ALSO SUPPORTED BY THE ENEA NOTE ON INSULATING PANELS (DECEMBER 2020), WHICH EXPLAINS HOW TO DECLARE THERMAL PERFORMANCE FOR INTERVENTIONS THAT ACCESS TAX INCENTIVES.

Importancia de la Norma UNI 11716:2018

La **UNI 11716:2018** es fundamental para:

- Asegurar la Calidad: Garantiza que los instaladores de **sistemas SATE** tengan las competencias necesarias para realizar trabajos de alta calidad, contribuyendo a la eficiencia energética de los edificios.
- Profesionalizar el Sector: Reconoce y define las competencias específicas de las figuras profesionales, promoviendo la profesionalización del sector de aislamiento térmico.
- Proteger a los Consumidores: Asegura que los clientes puedan confiar en profesionales calificados, reduciendo el riesgo de trabajos mal ejecutados y mejorando la durabilidad y el rendimiento de los sistemas de aislamiento.

EN RESUMEN, LA NORMA **UNI 11716:2018** REPRESENTA UN AVANCE SIGNIFICATIVO HACIA LA ESTANDARIZACIÓN Y LA MEJORA DE LA CALIDAD DE LOS TRABAJOS DE INSTALACIÓN DE SISTEMAS DE AISLAMIENTO TÉRMICO EXTERIOR, ASEGURANDO QUE LAS FIGURAS PROFESIONALES INVOLUCRADAS TENGAN LAS COMPETENCIAS NECESARIAS PARA OPERAR EFICAZMENTE Y EN CONFORMIDAD CON LAS NORMATIVAS VIGENTES.

LA MARCA CE

La marca CE para los productos de construcción está regulada por el Reglamento UE 305/2011, aplicado en Italia con el Decreto Legislativo 106/2017.

Los productos que deben llevar la marca CE son aquellos para los cuales existe una norma armonizada a nivel europeo. Si no existe tal norma, los productos pueden obtener la marca **CE** a través de un procedimiento voluntario conocido como **ETA (Evaluación Técnica Europea)**, basado en un **EAD (Documento de Evaluación Europeo)** que define las prestaciones a evaluar y las metodologías a utilizar.

Un "producto de construcción" puede ser un producto individual o un "kit", es decir, un conjunto de al menos dos componentes que deben ensamblarse para la instalación final. El sistema de aislamiento térmico es un ejemplo de kit. Actualmente, no existe una norma armonizada específica para los Sistemas de Aislamiento Térmico Exterior. Sin embargo, pueden obtener la marca CE de forma voluntaria haciendo referencia al EAD 040083-00-0404. En Italia, muchos sistemas de aislamiento térmico aún utilizan el ETA basado en ETAG 004, pero desde 2021, los nuevos ETA deben basarse en el EAD 040083-00-0404.

La **marca CE** de un sistema de aislamiento térmico **asegura un mejor rendimiento y durabilidad**, ya que los productos se prueban en laboratorio y **garantizan la compatibilidad entre los componentes**. El fabricante garantiza las prestaciones del sistema, por lo que es recomendable elegir un sistema **con marca CE**.

ESTA RECOMENDACIÓN TAMBIÉN ESTÁ RESPALDADA POR LA NOTA DE ENEA SOBRE LOS PANELES AISLANTES (DICEMBRE DE 2020), QUE EXPLICA CÓMO DECLARAR LAS PRESTACIONES TÉRMICAS PARA INTERVENCIONES QUE ACCEDEN A INCENTIVOS FISCALES.

Guida alla scelta dei Sistemi di Isolamento Termico a Cappotto di qualità.

Guide to choosing high-quality external thermal insulation systems.

Guía para elegir Sistemas de Aislamiento Térmico Exterior de Calidad.

quali criteri considerare per ottenere la massima affidabilità?

Per assicurarsi di scegliere un sistema di isolamento a cappotto efficace, duraturo e conforme alle norme di riferimento, un progettista o un committente deve optare per un sistema di isolamento termico a cappotto certificato, avendo cura che la progettazione e la posa vengano eseguite da posatori qualificati, in possesso del patentino "Installatore base di Sistemi ETICS" secondo la norma UNI 11716.

CERTIFICAZIONE DI SISTEMA, COSA SI INTENDE?

La certificazione di sistema si riferisce alla Valutazione Tecnica Europea (ETA) e alla Marcatura CE. L'ETA è una valutazione ufficiale della performance del KIT, rilasciata da un Organismo di Valutazione Tecnica accreditato (TAB) secondo la specifica tecnica EAD 0400083-00-0404, valida per sistemi su supporti in muratura. Questa specifica dettaglia i numerosi test che il sistema deve superare per ottenere il rilascio della certificazione finale. I test valutano sia le performance dell'intero sistema ETICS sia dei singoli componenti: materiali isolante, tasselli, profili, colle rasanti, finiture e armature.

La certificazione è riconosciuta in tutti gli Stati membri dell'UE e nell'Area Economica Europea.

what criteria to consider for maximum reliability?

To select an effective, durable, and compliant external thermal insulation system, a designer, engineer or client should choose a certified ETICS, ensuring that both the design and installation are carried out by qualified installers holding the "ETICS Systems Basic Installer" certificate according to Italian law UNI 11716.

WHAT IS MEANT BY SYSTEM CERTIFICATION?

System certification refers to the European Technical Assessment (ETA) and CE marking. The ETA is an official evaluation of the system's performance, issued by an accredited Technical Assessment Body (TAB) according to the EAD 0400083-00-0404 technical specification, valid for systems on masonry substrates. This specification details the numerous tests that the system must pass to obtain final certification. The tests assess both the performance of the entire ETICS and its individual components: insulation materials, dowels, profiles, adhesives, finishes and reinforcements.

The certification is recognized across all EU Member States and the European Economic Area.

¿Cómo garantizar la máxima fiabilidad?

Para asegurarse de seleccionar un sistema de aislamiento térmico exterior efectivo, duradero y conforme con las normativas, un diseñador, un ingeniero o cliente debe optar por un sistema certificado, asegurándose de que el diseño y la instalación sean realizados por instaladores cualificados, con la licencia "Instalador básico de Sistemas SATE" según la norma italiana UNI 11716.

¿QUÉ ES LA CERTIFICACIÓN DE SISTEMA?

La certificación de sistema se refiere a la Evaluación Técnica Europea (ETA) y la marcación CE. La ETA es una evaluación oficial del rendimiento del KIT, emitida por un Organismo de Evaluación Técnica acreditado (TAB) según la especificación técnica EAD 0400083-00-0404, válida para sistemas sobre soportes de mampostería. Esta especificación detalla los numerosos ensayos que el sistema debe superar para obtener la certificación final. Los ensayos evalúan tanto el rendimiento del sistema SATE completo como de los componentes individuales: materiales aislantes, anclajes, perfiles, adhesivos, acabados y refuerzos.

La certificación es reconocida en todos los Estados miembros de la UE y en el Área Económica Europea.

attestazione di conformità, marcatura CE e KIT

Per garantire che il sistema ETICS fornito in cantiere abbia le prestazioni indicate nell'ETA è essenziale verificare la presenza della Marcatura CE.

A seguire i passaggi necessari per ottenerla:

1. Ottenere una Valutazione Tecnica Europea (ETA);
2. Implementare un sistema di Controllo della produzione in Fabbrica (FPC) e sottoporsi a una verifica annuale da parte di un Ente Notificato (NB);
3. Redigere la Dichiarazione di Prestazione (DoP), che certifica la conformità del Sistema a Cappotto con la marcatura CE.

È importante sottolineare che, secondo il Regolamento europeo, la Marcatura CE può essere apposta solo se tutti i componenti del KIT sono immessi sul mercato da un unico produttore (v. art. 2 del CPR 305/2011, recepito in Italia dal D.lgs. 106/2017). Solo in questo modo si può parlare di sistema certificato e di KIT.

La marcatura CE per un KIT con ETA è obbligatoria?

No, tuttavia, in assenza di Marcatura CE e della verifica annuale da parte di un organismo notificato, la validità dell'ETA decade.

Quale documento attesta la prestazione di Reazione al Fuoco del KIT?

La Dichiarazione di Prestazione del Sistema (DoP), redatta sulla base dell'ETA, è il documento con valore legale, in quanto firmato dal rappresentante legale del produttore del Sistema a Cappotto, che certifica la prestazione di Reazione al Fuoco del KIT.

conformity attestation, CE marking and KIT

To ensure that the ETICS system provided on-site performs as indicated in the ETA, it is essential to verify the presence of the CE Marking.

The steps to get it are as follows:

1. Obtain a European Technical Assessment (ETA);
2. Implement a Factory Production Control (FPC) system and undergo an annual audit by a Notified Body (NB);
3. Draft the Declaration of Performance (DoP), certifying the ETICS compliance with CE marking.

It is important to note that, according to European regulations, the CE marking can only be affixed if all KIT components are placed on the market by a single manufacturer (see Article 2 of CPR 305/2011, adopted in Italy by Legislative Decree 106/2017). Only in this way can the system be considered certified and a KIT.

Is CE marking for a KIT with ETA mandatory?

In absence of CE marking and annual verification by a notified body, the validity of the ETA lapses.

Which document certifies the Fire Reaction performance of the KIT?

The System's Declaration of Performance (DoP), drafted based on the ETA, is the legally binding document, as it is signed by the legal representative of the ETICS manufacturer, certifying the KIT's Fire Reaction performance.

declaración de conformidad, marcado CE y KIT

Para garantizar que el sistema SATE entregado en la obra tenga las prestaciones indicadas en la ETA, es esencial verificar la presencia del marcado CE.

Los pasos necesarios para obtenerlo son:

1. Obtener una Evaluación Técnica Europea (ETA);
2. Implementar un sistema de Control de Producción en Fábrica (FPC) y someterse a una auditoría anual por parte de un Organismo Notificado (NB);
3. Redactar la Declaración de Prestaciones (DoP), que certifica la conformidad del Sistema de Aislamiento Térmico Exterior con el marcado CE.

Es importante destacar que, según el Reglamento Europeo, el marcado CE solo puede aplicarse si todos los componentes del kit son comercializados por un único fabricante (ver art. 2 del CPR 305/2011, adoptado en Italia por el D.lgs. 106/2017). Solo de este modo se puede hablar de sistema certificado y de KIT.

¿Es obligatorio el marcado CE para un KIT con ETA?

No, sin embargo, en ausencia de marcado CE y de la auditoría anual por parte de un organismo notificado, la validez de la ETA caduca.

¿Qué documento certifica la prestación de Reacción al Fuego del KIT?

La Declaración de Prestaciones del Sistema (DoP), redactada en base a la ETA, es el documento con valor legal, ya que está firmado por el representante legal del fabricante del Sistema de Aislamiento Térmico por el Exterior, certificando la prestación de Reacción al Fuego del KIT.



Un approccio virtuoso per il futuro

A virtuous approach for the future

Un enfoque virtuoso para el futuro

La sostenibilità ambientale rappresenta oggi la sfida principale del settore edile italiano ed europeo con l'obiettivo di raggiungere la **neutralità climatica entro il 2050** e la riduzione del 55% dei consumi energetici (**programma europeo Fit for 55**).

E' inoltre confermata l'approvazione da parte del **Parlamento EU della Direttiva EPBD** (Energy Performance of Buildings Directive), chiamata direttiva "Case Green", che prevede che gli stati membri adottino misure per garantire una riduzione dell'utilizzo di energia primaria da parte degli edifici. In questo contesto è **indispensabile riqualificare il patrimonio edilizio esistente**, responsabile del 40% del consumo energetico e del 36% delle emissioni di gas a effetto serra. In Italia questo significa riqualificare in **pochi anni circa 500 mila edifici pubblici** e 5 milioni di edifici privati con le prestazioni più scadenti.

Nel 1979 in anticipo su tempi e tendenze IVAS fu tra le prime aziende a lanciare sul mercato italiano la tecnologia del cappotto termico. Oggi l'attività di sostegno e divulgazione è svolta dalla divisione IVAS ETICS, che **promuove la cultura del sistema a cappotto (KIT)** come sinonimo di protezione e recupero del patrimonio edilizio, qualificazione energetica, riduzione dell'impatto ambientale, miglioramento del benessere e comfort abitativo. Il marchio di linea termok8 rappresenta la migliore soluzione tecnologica e sostenibile per ridurre il fabbisogno energetico, migliorando il comfort e l'estetica dell'edificio.

Nella sede di Gruppo IVAS viene prodotto il dato più importante di efficientamento energetico e riduzione di emissioni di CO2 degli edifici italiani. Grazie ai Sistemi a Cappotto Ivas ogni anno **vengono abbattuti in Italia circa 115 milioni di kg di CO2**. Un Sistema a Cappotto consente di ridurre i consumi energetici delle abitazioni rispettivamente fino a circa il 45% nei condomini e fino a circa il 33% nelle case singole, confermandosi come la tecnologia più impattante per raggiungere gli obiettivi delle direttive europee.

Environmental sustainability is currently the main challenge facing the Italian and European construction sectors, with the goal of achieving **climate neutrality by 2050** and reducing energy consumption by 55% (**as outlined in the European "Fit for 55" program**).

It is also confirmed the approval by the **EU Parliament of the EPBD Directive** (Energy Performance of Buildings Directive), called "Green Deal" directive which requires Member States to take measures to ensure a reduction in primary energy use by buildings. In this context, **it is essential to redevelop the existing building stock**, responsible for 40% of energy consumption and 36% of greenhouse gas emissions. In Italy this means upgrading in a few years **about 500 thousand public buildings** and 5 million private buildings with the lowest performance.

In 1979, ahead of its time and trends, IVAS was among the first companies to introduce thermal insulation technology to the Italian market. Today, the support and dissemination activities are carried out by the IVAS ETICS division, **which promotes the culture of the thermal insulation system (KIT)** as a synonym for the protection and restoration of the building heritage, energy efficiency, environmental impact reduction, and improvement of residential well-being and comfort. The termok8 brand represents the best technological and sustainable solution to reduce energy demand, while enhancing both the comfort and aesthetics of the building.

At the headquarters of the IVAS Group, the most significant data on energy efficiency and CO2 emission reduction in buildings in Italy is generated. Thanks to IVAS Thermal Insulation Systems (ETICS) **approximately 115 million kg of CO2** are reduced annually in Italy. A Thermal Insulation System allows for a reduction in energy consumption by up to 45% in apartment buildings and up to 33% in single-family homes, confirming it as the most impactful technology for achieving the goals set by European directives.

La sostenibilità ambientale es hoy el principal desafío del sector de la construcción en Italia y Europa, con el objetivo de alcanzar la **neutralidad climática para 2050** y reducir el 55% del consumo energético (**programa europeo Fit for 55**).

También se ha confirmado la aprobación por el **Parlamento de la UE de la Directiva EPBD** (Energy Performance of Buildings Directive), llamada directiva "Case Green" que prevé que los Estados miembros adopten medidas para garantizar una reducción del uso de energía primaria por parte de los edificios. En este contexto, es **indispensable recalificar el patrimonio inmobiliario existente**, responsable del 40% del consumo energético y del 36% de las emisiones de gases de efecto invernadero. En Italia esto significa rehabilitar **en pocos años unos 500.000 edificios públicos** y 5 millones de edificios privados con las prestaciones más deficientes.

En 1979, adelantándose a su tiempo y a las tendencias, IVAS fue una de las primeras empresas en lanzar al mercado italiano la tecnología del aislamiento térmico exterior. Hoy en día, la actividad de apoyo y difusión la lleva a cabo la división IVAS SATE, **que promueve la cultura del sistema de aislamiento térmico exterior (KIT)** como sinónimo de protección y recuperación del patrimonio edilicio, calificación energética, reducción del impacto ambiental, y mejora del bienestar y confort habitacional. La línea de productos termok8 representa la mejor solución tecnológica y sostenible para reducir la demanda energética, mejorando el confort y la estética.

En la sede de Grupo IVAS se genera el dato más importante sobre eficiencia energética y reducción de emisiones de CO2 en edificios en Italia. Gracias a los Sistemas de Aislamiento Térmico por el Exterior (SATE) de IVAS y a las fachadas ventiladas, se reducen anualmente **en Italia aproximadamente 115 millones de kg de CO2**. Un Sistema de Aislamiento Térmico por el Exterior permite reducir el consumo energético de las viviendas en hasta un 45% en edificios residenciales y hasta un 33% en casas unifamiliares, consolidándose como la tecnología más impactante para alcanzar los objetivos de las directivas europeas.





IVASPOR®
... TECHNOLOGY ...

lastre isolanti per l'edilizia

La **divisione produttiva** IVAS EPS+ progetta e produce lastre isolanti in eps (polistireno espanso sinterizzato) riciclato, nel nuovo stabilimento 4.0 di San Mauro Pascoli, alimentato da **energia rinnovabile**, attraverso un impianto di pannelli fotovoltaici da 650 Kw. Il moderno impianto consente di produrre circa 300.000 m³ l'anno, corrispondenti a circa 2,5 milioni di m² di pannelli isolanti, **incidendo positivamente sulla coibentazione delle facciate e sulla riduzione delle emissioni di CO2**. L'EPS, viene prodotto in lastre tramite la tecnologia proprietaria **IVASPOR®** - certificata **"Remade in Italy"** a garanzia di un prodotto di qualità e con un effettivo contenuto di riciclato al suo interno, **composto al 98% da aria** intrappolata in cellette chiuse di dimensioni limitate, che favoriscono elevate prestazioni termiche, permette di limitare le dispersioni, contribuendo al risparmio energetico nella climatizzazione estiva e invernale e riducendo le emissioni ad effetto serra. Dalla gestione unica dell'intero processo produttivo deriva un livello straordinario di personalizzazione con lavorazioni custom e progetti su misura, anche in forniture ridotte, come lavorazioni superficiali e modellazioni volumetriche di facciata grazie ad un complesso pantografo industriale e l'affiancamento tecnico necessario a concretizzare ogni idea stilistica e architettonica in realtà.

Durante il processo produttivo, gli sfridi di lavorazione vengono interamente riutilizzati nel ciclo di trasformazione, consentendo di realizzare un circuito virtuoso a zero rifiuti.

insulation panels for construction

The IVAS EPS+ **production division** designs and manufactures insulating panels in EPS (expanded sintered polystyrene) from recycled materials. At the new Industry 4.0 facility in San Mauro Pascoli, powered by **renewable energy** through a 650 kWp photovoltaic system, the modern plant produces approximately 300,000 m³ annually, equivalent to about 2.5 million m² of insulating panels. This contributes **positively to facade insulation and the reduction of CO2 emissions**. The EPS is produced in panels using IVAS's proprietary **IVASPOR® technology**, certified **"Remade in Italy,"** ensuring a high-quality product with a genuine recycled content. **Composed of 98% air** trapped in small closed cells that provide excellent thermal performance, it minimizes heat loss, contributing to energy savings for both summer cooling and winter heating while reducing greenhouse gas emissions. The unique management of the entire production process allows for extraordinary customization, including bespoke projects and small-scale supplies. These include surface treatments and volumetric facade modeling, achieved with a **sophisticated industrial pantograph**, along with the technical support necessary to transform every stylistic and architectural concept into reality. During the production process, all manufacturing scraps are fully recycled within the transformation cycle, enabling a virtuous zero-waste system.

During the production process, all processing scraps are fully reused in the transformation cycle, creating a zero-waste virtuous loop.

paneles aislantes para la construcción

La **división productiva** IVAS EPS+ diseña y produce placas aislantes de EPS (poliestireno expandido sinterizado) riciclado. En la nueva planta 4.0 de San Mauro Pascoli, alimentada con **energía renovable** gracias a un sistema de paneles fotovoltaicos de 650 kWp, el moderno complejo permite producir aproximadamente 300.000 m³ al año, equivalentes a unos 2,5 millones de m² de paneles aislantes, **contribuyendo positivamente al aislamiento térmico de las fachadas y a la reducción de las emisiones de CO2**. El EPS se fabrica en placas mediante la tecnología patentada **IVASPOR®**, certificada **"Remade in Italy"**, lo que garantiza un producto de calidad con un contenido real de material reciclado. Este material, **compuesto en un 98%** por aire atrapado en pequeñas celdas cerradas que favorecen un alto rendimiento térmico, limita las pérdidas de energía, contribuyendo al ahorro energético en la climatización tanto en verano como en invierno, y reduce las emisiones de gases de efecto invernadero. La gestión integral de todo el proceso productivo permite alcanzar un nivel extraordinario de personalización, ofreciendo trabajos a medida y proyectos personalizados, incluso en pedidos pequeños, como acabados superficiales y modelados volumétricos de fachadas gracias a un **complejo pantógrafo industrial**, además de brindar la asistencia técnica necesaria para transformar cualquier idea estilística y arquitectónica en realidad. Durante el proceso de producción, los residuos generados se reutilizan por completo en el ciclo de transformación, logrando así un circuito virtuoso sin residuos.

Durante el proceso de producción, los residuos de fabricación se reutilizan completamente en el ciclo de transformación, permitiendo crear un circuito virtuoso de cero residuos.

ivas - unico produttore italiano di kit a km 0

IVAS con l'inaugurazione della divisione produttiva EPS+, unendo alla già precedente produzione di fissativi, malte, collanti e rivestimenti, diventa il primo e unico sistemista sul mercato italiano a proporre KIT ETICS di sistemi a cappotto autoprodotti a km 0 con una filiera corta e controllata, **certificati ETA, Dop e CE**, proponendo le **migliori soluzioni** per risolvere nodi critici progettuali, applicativi, **logistici e distributivi a garanzia** di progettisti, rivendite ed imprese.

ivas - the only italian producer of zero-km insulation kits

With the inauguration of the EPS+ production division, IVAS, adding to its existing production of primers, mortars, adhesives and coatings, becomes the first and only system provider in the Italian market to offer ETICS kits for self-produced insulation systems with a zero-mile, short, and controlled supply chain. These kits are **certified with ETA, DoP, and CE marks**, offering the **best solutions** to address critical design, application, logistics, and distribution challenges, **ensuring reliability** for designers, distributors, and construction companies.

ivas - único productor italiano de kits a km 0

IVAS, con la inauguración de la división productiva EPS+, sumando a la ya consolidada producción de fijadores, morteros, adhesivos y revestimientos, se convierte en el primer y único proveedor integral del mercado italiano en ofrecer KIT ETICS de sistemas de aislamiento térmico exterior SATE autogestionados y producidos a km 0, con una cadena de suministro corta y controlada, **certificados ETA, DoP y CE**. De esta manera, IVAS ofrece las **mejores soluciones** par resolver los puntos críticos en el diseño, la aplicación, la logística y la distribución, **garantizando tranquilidad** a proyectistas, distribuidores empresas.

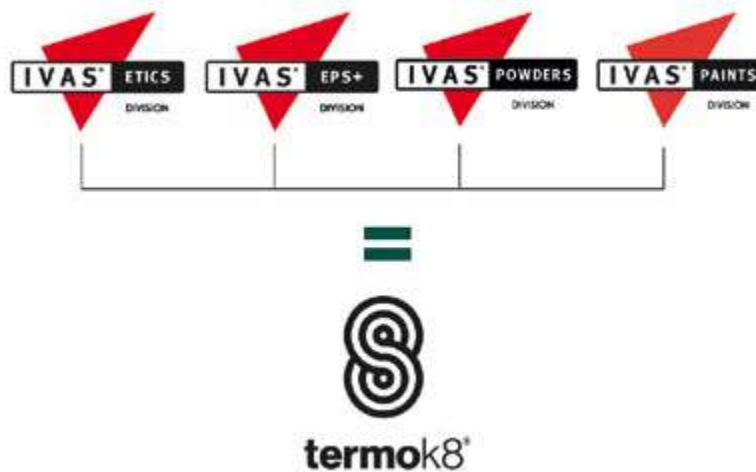

con ivas nasce la green building valley

IL PRIMO DISTRETTO ITALIANO DELL'EFFICIENTAMENTO ENERGETICO DELL'INVOLUCRO EDILIZIO

Con l'inaugurazione del nuovo sito produttivo EPS+ è stata proclamata la nascita della Green Building Valley - Il Distretto dell'Efficientamento Energetico dell'Involucro Edilizio.

La Green Building Valley è un'iniziativa di Gruppo IVAS, atta a **promuovere la cultura dell'efficientamento energetico e della riqualificazione ecosostenibile dell'involucro edilizio** attraverso la creazione di un ecosistema collaborativo, che prevede il coinvolgimento di altri attori della filiera edilizia, dell'energia e dell'ambiente per favorire la sinergia virtuosa tra competenze e risorse per la divulgazione di **soluzioni innovative e sostenibili** nella comunità e presso enti istituzionali, professionali e formativi.

La **Green Building Valley** rappresenta la necessità di generare dinamiche di sviluppo basate su informazione, consapevolezza, innovazione tecnica e tecnologica intese come opportunità per rendere le comunità socialmente più inclusive, ecologicamente meno impattanti e più resilienti.

with ivas, the green building valley is born

THE FIRST ITALIAN DISTRICT FOR ENERGY EFFICIENCY IN BUILDING ENVELOPES

With the inauguration of the new EPS+ production site, the Green Building Valley – the District for Energy Efficiency in Building Envelopes – was officially launched.

The Green Building Valley is a Group initiative aimed at **promoting the culture of energy efficiency and sustainable redevelopment of building envelopes** through the creation of a collaborative ecosystem. This initiative involves other stakeholders in the construction, energy, and environmental sectors to foster a virtuous synergy of expertise and resources, advancing the dissemination of innovative and **sustainable solutions** within the community and among institutional, professional, and educational entities.

The **Green Building Valley** embodies the necessity of generating development dynamics based on information, awareness, and technical and technological innovation. These are seen as opportunities to make communities socially more inclusive, ecologically less impactful, and more resilient.

con ivas nasce la green building valley

EL PRIMER DISTRITO ITALIANO DE EFICIENCIA ENERGÉTICA DE LA ENVOLVENTE EDILICIA

Con la inauguración del nuevo sitio de producción EPS+, se proclamó el nacimiento de la Green Building Valley – El Distrito de la Eficiencia Energética del Envolverte Edilicio.

La Green Building Valley es una iniciativa del Grupo diseñada para **promover la cultura de la eficiencia energética y la rehabilitación sostenible del envolvente edilicio** mediante la creación de un ecosistema colaborativo. Este ecosistema implica la participación de otros actores de la cadena de valor de la construcción, la energía y el medio ambiente, fomentando la sinergia virtuosa entre competencias y recursos para la difusión de **soluciones innovadoras y sostenibles** en la comunidad y ante entidades institucionales, profesionales y educativas.

La **Green Building Valley** representa la necesidad de generar dinámicas de desarrollo basadas en información, conciencia, e innovación técnica y tecnológica, concebidas como oportunidades para hacer a las comunidades más socialmente inclusivas, ecológicamente menos impactantes y más resilientes.



Con IVAS nasce la Green Building Valley

WITH IVAS, THE GREEN BUILDING VALLEY IS BORN
CON IVAS NACE LA GREEN BUILDING VALLEY



IL PRIMO DISTRETTO ITALIANO
DELL'EFFICIENTAMENTO ENERGETICO
DELL'INVOLUCRO EDILIZIO

THE FIRST ITALIAN DISTRICT FOR ENERGY EFFICIENCY IN BUILDING ENVELOPES
EL PRIMER DISTRITO ITALIANO DE EFICIENCIA ENERGÉTICA DE LA ENVOLVENTE EDILICIA

Termok8: l'eccellenza nell'isolamento termico che soddisfa ogni esigenza.

Termok8: the excellence in thermal insulation that meets every need.

Termok8: la excelencia en aislamiento térmico que satisface todas las necesidades.

La tabella seguente illustra la gamma completa dei sistemi d'isolamento termico a cappotto IVAS e le relative certificazioni di sistema. Il brand termok8 comprende svariati sistemi differenziati e specializzati per offrire la soluzione più adeguata ad esigenze di natura ingegneristica, architettonica o esecutiva, per la più efficiente gestione energetica del "sistema edificio". Le soluzioni proposte - sostenibili e di comprovata qualità - sono prodotte a Km0 nell'innovativo stabilimento produttivo di materiali isolanti IVAS EPS+, la cui tecnologia di pannelli isolanti IVASPOR® è certificata "Remade in Italy".

The following table illustrates the complete range of IVAS external thermal insulation systems and their respective system certifications. The termok8 brand includes a variety of specialized and differentiated systems designed to provide the most suitable solution for engineering, architectural, or execution requirements, ensuring the most efficient energy management of the "building system". The proposed solutions, which are sustainable and of proven quality, are produced locally at the innovative IVAS EPS+ insulating materials manufacturing plant. The technology used in IVASPOR® insulating panels is certified "Remade in Italy."

La siguiente tabla muestra la gama completa de sistemas de aislamiento térmico exterior IVAS y las correspondientes certificaciones del sistema. La marca termok8 incluye diversos sistemas diferenciados y especializados para ofrecer la solución más adecuada a las necesidades de naturaleza ingenieril, arquitectónica o ejecutiva, para la gestión energética más eficiente del "sistema edificio". Las soluciones propuestas, sostenibles y de calidad comprobada, son producidas a Km0 en la innovadora planta de producción de materiales aislantes IVAS EPS+, cuya tecnología de paneles aislantes IVASPOR® está certificada como "Remade in Italy".

SISTEMA IVAS K8; Termok8 SYSTEM; SISTEMA Termok8	TIPOLOGIA ISOLANTE INSULATION PANEL TYPE TIPOLOGÍA DE PANEL AISLANTE	CERTIFICAZIONE ETA - CE ETA - CE CERTIFICATION CERTIFICACIÓN ETA - CE	CLASSE DI REAZIONE AL FUOCO FIRE REACTION CLASS CLASE DE REACCIÓN AL FUEGO
Termok8® classico convertito	EPS	ETA 10/0231	B-s1,d0 - System DoP certified n°365208 by Istituto Giordano
Termok8® grafite plus convertito	EPS	ETA 10/0231	B-s1,d0 - System DoP certified n°365208 by Istituto Giordano
Termok8® bw convertito	EPS	ETA 10/0231	B-s1,d0 - System DoP certified n°365208 by Istituto Giordano
Termok8® hp convertito	EPS	ETA 10/0231	B-s1,d0 - System DoP certified n°365208 by Istituto Giordano
Termok8® fonostop convertito	EPS	ETA 10/0231	B-s1,d0 - System DoP certified n°365208 by Istituto Giordano
Termok8® ar max 20 j	EPS	ETA 10/0231	B-s1,d0 - System DoP certified n°365208 by Istituto Giordano
Termok8® ar max 60 j	EPS		
Termok8® meccanico	EPS		B-s1,d0 certified n°398069 by Istituto Giordano
Termok8® fenolico	RESINA FENOLICA (PF)	ETA 24/0904	B-s1,d0 certified n°399270 by Istituto Giordano
Termok8® slim	PIR (POLIURETANO)	ETA 24/0905	B-s1,d0 certified n°412718 by Istituto Giordano
Termok8® minerale l.v.	LANA MINERALE (MW)	ETA 10/0231	A2-s1,d0 - System DoP certified n°1909T09-2 by AFITI
Termok8® minerale l.r.	LANA MINERALE (MW)	ETA 10/0231	A2-s1,d0 - System DoP certified n°396452 by Istituto Giordano
Termok8® wood	FIBRA DI LEGNO		
Termok8® sughero	SUGHERO		
Termok8® minerale eco	MULTIPOR		
Termok8® modular flex l.r.	LANA MINERALE (MW)		A2-s1,d0 certified n°396657 by Istituto Giordano
Termok8® modular flex	EPS		B-s2,d0 certified BBA n° 11/4841
Termok8® modular facciavista	EPS	ETA 23/0221	B-s1,d0 - System DoP certified n°404309 by Istituto Giordano
Termok8® modular D	EPS	ETA 23/0221	B-s1,d0 - System DoP certified n°404308 by Istituto Giordano
Termok8® modular big	EPS	ETA 23/0221	B-s1,d0 - System DoP certified n°404307 by Istituto Giordano
Termok8® modular biostone	EPS	ETA 23/0221	B-s1,d0 certified n°40310 by Istituto Giordano





complesso direzionale, **termok8**® design con finitura Texture cemento spazzolato, roma, it



tipologie d'isolanti

types of insulation

tipos de aislantes

La scelta della tipologia del materiale isolante è fondamentale per la definizione delle caratteristiche fisiche, meccaniche e prestazionali del sistema (e non solo in termini termo-acustici) nonché per la definizione del suo spessore d'uso in funzione della sua efficienza.

Ogni materiale ha una propria capacità di trasmettere il calore, rappresentata dalla conducibilità (o conduttività) termica λ (lambda), espressa in $W/(m \cdot K)$: minore è il valore di λ , minore è la capacità del materiale di trasmettere il calore, quindi maggiore è la sua capacità d'isolamento.

Il rapporto tra lo spessore s dell'isolante e la sua conducibilità corrisponde alla resistenza termica $R = s/\lambda$ espressa in m^2K/W , cioè la capacità di un materiale di opporsi al flusso di calore che tende ad attraversarlo. Un isolante termico è caratterizzato da un'alta resistenza termica R .

The choice of type of insulation material is fundamental for the definition of the system's physical, mechanical, and performance properties (not only in thermal and acoustic terms), as well as for establishing the thickness to be used, based on its performance.

Each material has a particular capacity to transmit heat, represented by its thermal conductivity λ (lambda) expressed by $W/(m \cdot K)$. The lower the value of λ , the lower is the material's capacity to transmit heat and thus the greater are its insulation capabilities.

The relationship between the thickness s of the insulating material and its thermal conductivity corresponds to the thermal resistance $R = s/\lambda$, expressed in m^2K/W , which represents the ability of a material to resist the heat flow attempting to pass through it. A thermal insulator is characterized by a high thermal resistance R .

La elección del tipo de material aislante es fundamental para definir las características físicas, mecánicas y de prestaciones del sistema (y no sólo en términos termo-acústicos), así como para definir el espesor que va a usarse en función de su eficiencia.

Cada material tiene su propia capacidad de transmitir el calor, representada por la conductividad térmica λ (lambda), expresada en $W/(m \cdot K)$: cuanto menor es el valor de λ , menor es la capacidad del material de transmitir el calor, y por tanto, mayor es su capacidad de aislamiento.

El cociente entre el espesor s del aislante y su conductividad térmica corresponde a la resistencia térmica $R = s/\lambda$, expresada en m^2K/W , es decir, la capacidad de un material para oponerse al flujo de calor que tiende a atravesarlo. Un aislante térmico se caracteriza por una alta resistencia térmica R .

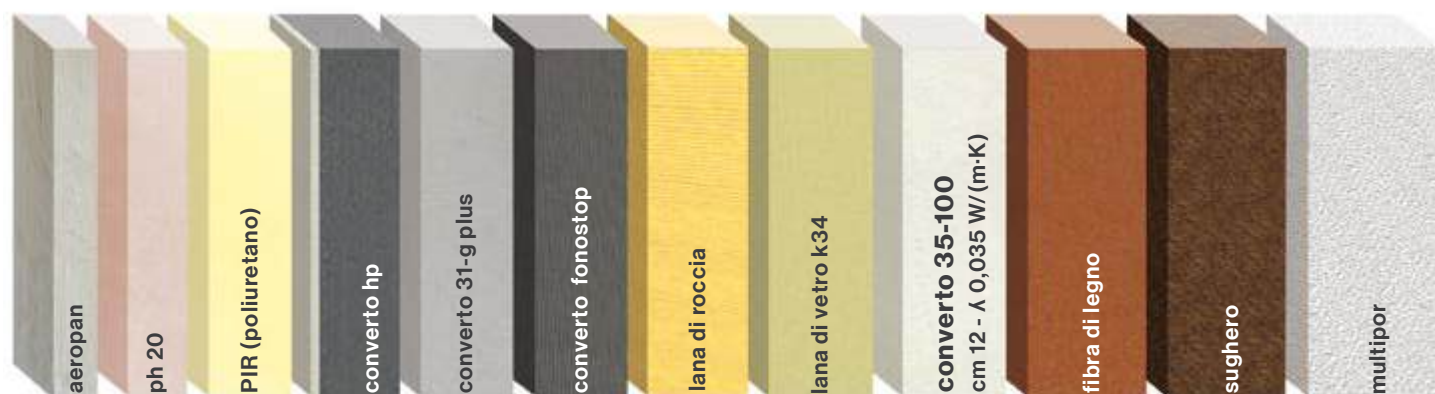

stessa trasmittanza termica

same thermal transmittance value

misma transmitancia térmica

isolante insulation aislante	spessore (cm) thickness (cm) espesor (cm)	λ $W/(m \cdot K)$
aeropan	5,2	0,015
ph 20	6,9	0,021
PIR (poliuretano)	8,9	0,026
convertito hp	10,3	0,030
convertito 31-g plus	10,7	0,031
convertito fonostop	10,7	0,031
lana di roccia	11,7	0,034
lana di vetro k34	11,7	0,034
convertito 35 - 100	12,0	0,035
fibra di legno	13,7	0,040
sughero	13,7	0,040
multiopor	15,5	0,045

a sinistra e in alto:
confronto fra gli spessori dei differenti materiali isolanti, necessari ad ottenere la medesima trasmittanza termica di un Convertito 35 - 100 da 12 cm (preso come benchmark - standard di settore) applicati su un medesimo supporto

above and to the left:
comparison between the thicknesses of the different insulation materials needed to achieve the same thermal transmittance as a 12 cm Convertito 35 - 100 (taken as a benchmark - industry standard) applied to the same substrate

a la izquierda y arriba:
comparación de los espesores de los diferentes materiales aislantes, necesarios para obtener la misma transmitancia térmica de un Convertito 35 - 100 de 12 cm (tomado como benchmark - estándar del sector) aplicados sobre un mismo soporte

quartiere distretto merezzate, **termok8®** design modular big e **termok8®** Grafite plus converto, milano, it



prestazione acustica

acoustic performance

prestaciones acústicas

comportamento acustico delle facciate

L'isolamento acustico della facciata normalizzata rispetto al tempo di riverbero $D_{2m, nT, w}$ dipende dal potere fonoisolante di tutti gli elementi che compongono la facciata misurati dall'interno, dalla superficie della facciata esterna, dall'influenza della sua forma (ad esempio la presenza di balconi o tettoie) e dalle dimensioni degli ambienti interni.

L'efficacia della protezione acustica è influenzata quindi dalle proprietà acustiche di tutti gli elementi costituiscono la facciata, ma il risultato globale è solitamente penalizzato da elementi strutturali e architettonici di debolezza acustica (buchi acustici) quali finestre, porte, cassonetti e prese d'aria. La muratura opaca costituente le facciate esterne è solitamente di elevato spessore ed ha proprietà acustiche adeguate.

Al fine di determinare l'isolamento acustico globale di facciata occorre quindi conoscere i singoli indici di potere fonoisolante R'_w dei componenti opachi e trasparenti costituenti il sistema ed anche la rispettiva percentuale rispetto all'area complessiva della parete esterna.

Viene riportato un esempio per capire l'influenza dell'indice del potere fonoisolante di facciata (finestre + parete) sul valore richiesto dalla norma $D_{2m, nT, w}$ di una parete esterna di 10 m², il cui volume dell'ambiente interno sia pari a 50 m³ e il fattore correttivo di forma (prescritto dalla legge per compensare l'incertezza di misura) sia uguale a -1.

La parte finestrata della parete incide percentualmente per il 30%.

acoustic behaviour of façades

The sound insulation of the standardised façade with respect to the reverberation time $D_{2m, nT, w}$ depends on the soundproofing capacity of all the components of the façade measured from the inside, on the surface area of the external façade, on the influence of its shape (e.g. the presence of balconies or canopies), and on the size of the interior spaces.

The effectiveness of the acoustic protection is, therefore, influenced by the acoustic properties of all the components of the façade, but the overall result is usually adversely affected by acoustically weak structural and architectural elements (acoustic holes) such as windows, doors, shutters, and vents. The solid masonry comprising the exterior façades is usually quite thick and has appropriate acoustic properties.

In order to determine the overall sound insulation of a façade, it is therefore necessary to know the individual soundproofing capacity indices R'_w of the solid and transparent components comprising the system, as well as their respective percentages in relation to the overall area of the exterior wall.

Below is an example to understand the effect of the façade (windows + wall) soundproofing capacity index on the value required by the standard $D_{2m, nT, w}$ of a 10 m² exterior wall, whose interior space volume is 50 m³ and the shape correction factor (prescribed by law to compensate for measurement uncertainty) is equal to -1.

The windowed part of the wall accounts for 30%.

comportamiento acústico de las fachadas

El aislamiento acústico de la fachada normalizada en comparación con el tiempo de reverberación $D_{2m, nT, w}$ depende del poder de aislamiento acústico de todos los elementos que componen la fachada medidos desde el interior, de la superficie de la fachada externa, del impacto de su forma (por ejemplo la presencia de balcones o cobertizos) y del tamaño del interior.

La efectividad de la protección acústica está, por tanto, sujeta a las propiedades acústicas de todos los elementos que componen la fachada, pero el resultado generalmente se ve penalizado por elementos estructurales y arquitectónicos de debilidad acústica (agujeros acústicos) como ventanas, puertas, cajones y salidas de aire. La mampostería opaca que constituye las fachadas externas suele ser de gran espesor y tiene propiedades acústicas adecuadas.

Para determinar el aislamiento acústico global de la fachada, es necesario conocer los índices de poder de aislamiento acústico R'_w individuales de los componentes opacos y transparentes que constituyen el sistema y también su porcentaje.

Se da un ejemplo para entender la influencia del índice de poder de aislamiento acústico de la fachada (ventanas + paredes) en el valor requerido por la norma $D_{2m, nT, w}$ de una pared externa de 10 m², cuyo volumen del entorno interno es igual a 50 m³ y el factor correctivo de la forma (prescrito por la ley para compensar la incertidumbre de medición) es igual a -1.

La ventana de la pared representa un impacto del 30%.

	parete cieca solid wall pared ciega	parete finestrata windowed wall pared con ventanas (30%)
indice del potere fonoisolante R_w del singolo elemento soundproofing capacity index R_w of the individual element indice del poder de aislamiento acústico R_w de cada elemento	$R'_w = 52 \text{ dB}$	$R'_w = 35 \text{ dB}$
indice del potere fonoisolante di facciata façade soundproofing capacity index indice del poder de aislamiento acústico de la fachada	$R'_w = 40 \text{ dB}$	
indice dell'isolamento acustico standardizzato di facciata standardised façade sound insulation index indice del aislamiento acústico estandarizado de la fachada	$D_{2m, nT, w} = 41,2 \text{ dB}$	

Si evince che una parete con indice di potere fonoisolante di facciata pari a 40 dB riesce, nelle condizioni ipotizzate, a rispettare i limiti e le prescrizioni del D.P.C.M. 05/12/1997 per gli edifici adibiti a residenza e assimilabili.

It is evident that a wall with a façade soundproofing capacity index of 40 dB can, under the hypothesised conditions, comply with the limits and prescriptions of the Prime Ministerial Decree dated 05/12/1997 for residential and similar buildings.

Una pared con un índice de poder de aislamiento acústico de 40 dB puede, en las condiciones indicadas, respetar los límites y las disposiciones del D.P.C.M. 12/05/1997 para edificios utilizados como residencias y similares.

funzionamento acustico di un sistema a cappotto

Dal punto di vista acustico, la struttura di un sistema d'isolamento termo-acustico a cappotto è rappresentata da tre elementi: da un lato dalla parete portante, dall'altro dallo strato d'intonaco esterno, uniti meccanicamente attraverso lo strato isolante. L'isolante impiegato deve possedere proprietà elastiche idonee a ridurre la propagazione delle vibrazioni per via solida (bassa rigidità dinamica s') per creare un sistema composto da tre elementi distinti:

- la muratura di supporto considerata rigida e continua, di massa molto più elevata degli altri due strati;
- l'isolante che funge da molla, ovvero rappresenta il materiale che deve smorzare l'onda d'urto del suono;
- l'intonaco esterno che rappresenta l'elemento rigido ripartitore dell'energia meccanica che l'onda sonora provoca sulla superficie d'impatto.

acoustic functioning of an external thermal insulation system

From an acoustic point of view, the structure of an external thermal and acoustic insulation system consists of three elements: on the one hand the load-bearing wall and on the other hand the layer of external plaster, mechanically connected via the insulation layer. The insulation used must have elastic properties capable of reducing the propagation of solid vibrations (low dynamic stiffness s') to create a system comprised of three different elements:

- the substrate, which is considered rigid and continuous, with a much higher mass than the other two layers;
- the insulation, which acts as a spring, i.e. it is the material that must dampen the sound wave;
- the external plaster, which is a rigid element that distributes the mechanical energy produced by the sound wave on the impact surface.

funcionamiento acústico de un sistema de aislamiento térmico

Desde un punto de vista acústico, la estructura de un sistema de aislamiento térmico-acústico por capas está representada por tres elementos: de una parte la pared de soporte, por otra la capa de enfoscado externa, unida mecánicamente a través de la capa aislante. El aislante utilizado debe tener propiedades elásticas adecuadas para reducir la propagación de vibraciones por medios sólidos (baja rigidez dinámica s') para crear un sistema compuesto por tres elementos distintos:

- La mampostería de soporte se considera rígida y continua, de una masa mucho más alta que las otras dos capas
- El aislante que actúa como un muelle, es decir, el material que debe amortiguar la onda de choque del sonido
- El enfoscado externo que representa el elemento rígido que distribuye la energía mecánica que causa la onda de sonido en la superficie de impacto.

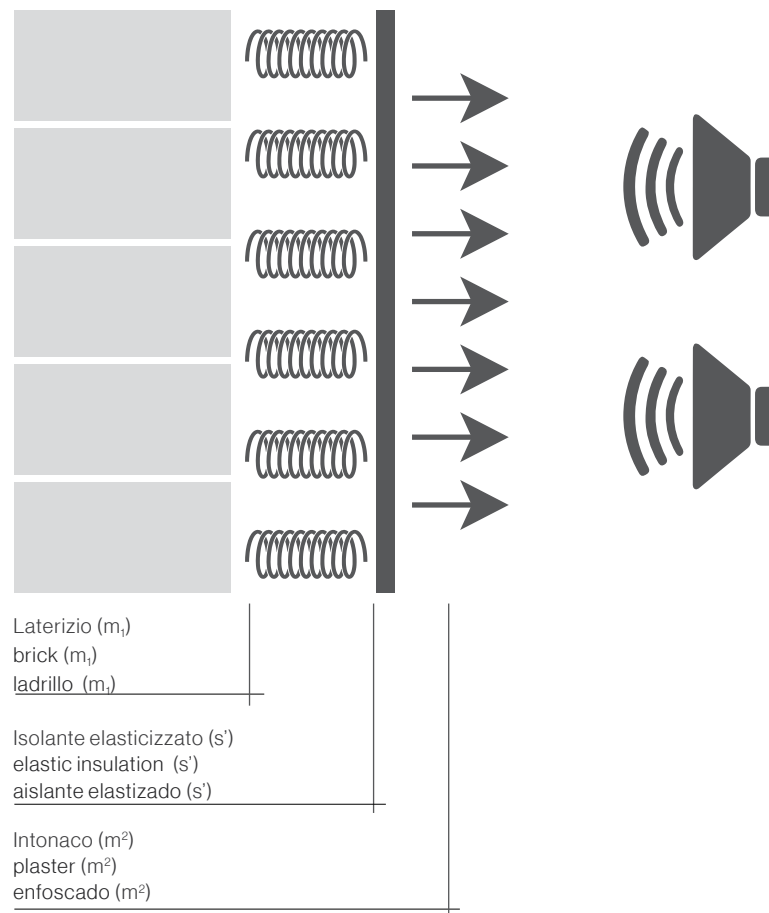

calcolo del miglioramento acustico della parete secondo la UNI EN ISO 12354-1

Conoscendo la frequenza di risonanza del sistema (f_0) applicando la formula a lato, e conoscendo il potere fonoisolante R_w della parete di partenza è possibile determinarne il miglioramento acustico ΔR_w

L'intero sistema quindi può essere considerato come composto da massa - molla - massa, i cui risultati acustici possono variare in funzione delle due masse (m_1 e m_2) e della rigidità dinamica (s') dell'isolante.

calculation of the acoustic improvement of the wall as per EN ISO 12354-1

Knowing the resonant frequency of the system (f_0) by applying the formula below, and knowing the soundproofing capacity R_w of the base wall, it is possible to calculate the acoustic improvement ΔR_w

The entire system can, therefore, be regarded as consisting of mass - spring - mass, the acoustic results of which may vary depending on the two masses (m_1 and m_2) and the dynamic stiffness (s') of the insulation.

cálculo de la mejora acústica de la pared en base a UNI EN ISO 12354-1

Conociendo la frecuencia de resonancia del sistema (f_0) aplicando la fórmula abajo y conociendo el poder de aislamiento acústico R_w de la pared inicial es posible determinar la mejora acústica ΔR_w

Por lo tanto, se puede considerar que todo el sistema está compuesto de masa - muelle - masa, cuyos resultados acústicos pueden variar dependiendo de las dos masas (m_1 y m_2) y la rigidez dinámica (s') del aislador.

$$f_0 = 160 \sqrt{s' \left(\frac{1}{m'_1} + \frac{1}{m'_2} \right)} \text{ (Hz)}$$

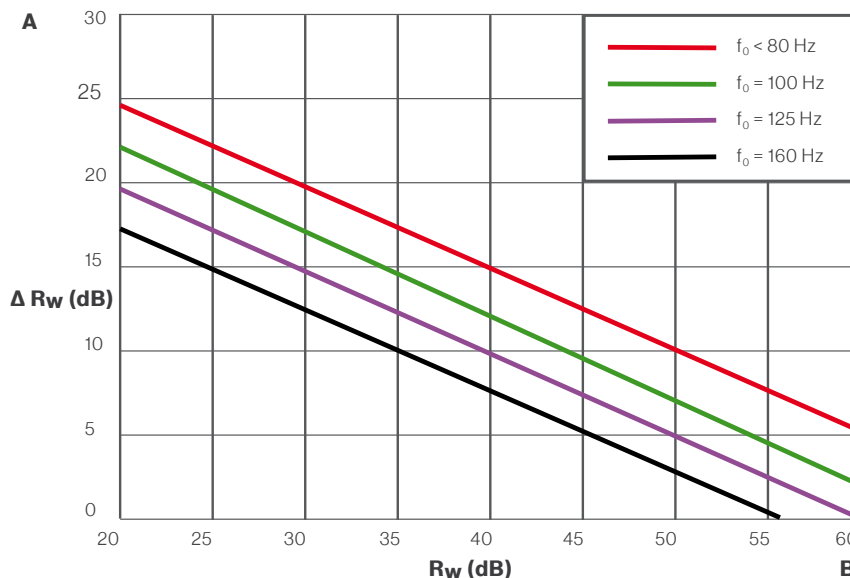

legenda

- A** aumento dell'indice di valutazione del potere fonoisolante, ΔR_w (dB)
- B** indice di valutazione del potere fonoisolante del solo muro o soffitto R_w (dB)

key

- A** increase in the evaluation index of the soundproofing capacity, ΔR_w (dB)
- B** evaluation index of the soundproofing capacity of the wall or ceiling alone R_w (dB)

leyenda

- A** aumento del índice de evaluación del poder de aislamiento acústico, ΔR_w (dB)
- B** índice de evaluación del poder de aislamiento acústico de la pared o del techo R_w (dB)

Nella figura D.1 presente nella norma UNI EN 12354-1, viene espresso il miglioramento acustico ΔR_w in funzione della frequenza di risonanza del sistema e del potere fonoisolante R_w della parete: al diminuire frequenza di risonanza f_0 , migliorano le prestazioni acustiche della parete. Quindi a parità di muratura (m_1) si avrà un maggiore isolamento acustico quando:

- aumenta lo spessore dell'intonaco esterno (m_2);
- diminuisce la rigidità dinamica dell'isolante (i).

In figure D.1 of Standard UNI EN 12354-1, the acoustic improvement ΔR_w is expressed as a function of the system's resonant frequency and the wall's soundproofing capacity R_w : as the resonant frequency f_0 decreases, the acoustic performance of the wall improves. Therefore, for the same masonry (m_1) there will be increased sound insulation when:

- the thickness of the external plaster increases (m_2);
- the dynamic stiffness of the insulation (i) decreases.

En la figura D.1 presente en la normativa UNI EN 12354-1, la mejora acústica ΔR_w se expresa en función de la frecuencia de resonancia del sistema y del poder de aislamiento acústico R_w de la pared: a medida que disminuye la frecuencia de resonancia f_0 , se mejora el rendimiento acústico de la pared. Con la misma mampostería (m_1) habrá un mayor aislamiento acústico cuando:

- aumenta el grosor del enfoscado externo (m_2)
- disminuye la rigidez dinámica del aislante (i)

la soluzione IVAS

La sempre maggiore rilevanza della protezione acustica degli edifici, spinge all'isolamento acustico delle pareti opache di facciata.

termok8 IVAS è la soluzione più semplice ed economica per ottemperare alle normative in materia di requisiti acustici degli edifici.

termok8 minerale l.r.

Soluzione ideale per rivestire ed isolare l'edificio ponendo particolare attenzione alle caratteristiche termoacustiche e di reazione al fuoco del sistema; è caratterizzato da elevata traspirabilità e da una composizione prevalentemente minerale.

materiale	spessore [m]	massa superficiale [kg/m ²]
rivatone plus g15	0,002	2,70
klebocem minerale	0,008	8,00
lana di roccia	0,120	2,00
klebocem minerale	0,005	6,00
laterizi forati sp.30 cm rif. 1.1.17	0,300	206,00
intonaco di cemento, sabbia e calce per esterno	0,015	27,00

dati generali	
rigidità dinamica isolante	
massa sup. intonaco esterno	10,70 kg/m ²
R' _w indice potere fonoisolante parete iniziale (senza isolante)	47 dB
Δ R' _w miglioramento dell'indice di potere fonoisolante della parete	9 dB
indice R'_w della parete con isolamento a cappotto	56 dB

the IVAS solution

The growing importance of the acoustic protection of buildings is driving the sound insulation of solid façade walls. IVAS termok8 is the simplest and most economical solution for complying with building acoustic requirements.

termok8 minerale l.r.

The ideal option for cladding and insulating a building, with particular emphasis on the system's thermal, acoustic and reaction to fire properties, featuring high breathability and a predominantly mineral composition.

material	thickness [m]	surface mass [kg/m ²]
rivatone plus g15	0,002	2,70
klebocem minerale	0,008	8,00
lana di roccia	0,120	2,00
klebocem minerale	0,005	6,00
30cm hollow bricks, ref. 1.1.17	0,300	206,00
cement, sand, and lime plaster for exteriors	0,015	27,00

general information	
dynamic stiffness of insulation	
ext. plaster surface mass	10,70 kg/m ²
wall's initial soundproofing capacity index R' _w (without insulation)	47 dB
improvement in the wall's soundproofing capacity index Δ R' _w	9 dB
wall's R'_w index with external thermal insulation	56 dB

la solución IVAS

La creciente importancia de la protección acústica de los edificios lleva al aislamiento acústico de las paredes opacas de la fachada.

termok8 IVAS es la solución más simple y económica para cumplir con las normativas sobre los requisitos acústicos de los edificios.

termok8 minerale l.r.

La solución ideal para revestir y aislar el edificio prestando particular atención a las características termoacústicas y de resistencia al fuego del sistema; se caracteriza por ser altamente transpirante y por su composición predominantemente mineral.

material	espesor [m]	masa superficial [kg/m ²]
rivatone plus g15	0,002	2,70
klebocem minerale	0,008	8,00
lana di roccia	0,120	2,00
klebocem minerale	0,005	6,00
ladrillos perforados esp. 30 cm ref. 1.1.17	0,300	206,00
enfoscado de cemento, arena y cal para exteriores	0,015	27,00

datos generales	
rigidez dinámica aislante	
masa sup. enfoscado externo	10,70 kg/m ²
R' _w índice de la capacidad de aislamiento acústico de la pared inicial (sin aislante)	47 dB
Δ R' _w de mejora del índice de la capacidad de aislamiento acústico de la pared	9 dB
índice R'_w de la pared con aislamiento por capas	56 dB

termok8 fonostop converto

Soluzione ideale per ottemperare con semplicità ed efficacia alle disposizioni in materia di efficienza energetica ed inquinamento acustico. Il sistema prevede quale isolante un pannello in EPS con grafite a bassa rigidità dinamica (requisito fondamentale per avere ottime prestazioni acustiche), caratterizzato da speciale zigrinatura che sopporta un intonaco esterno di elevato spessore.

materiale	spessore [m]	massa superficiale [kg/m ²]
rivatone plus g15	0,002	2,70
klebocem	0,008	8,00
converto fonostop	0,120	2,00
klebocem	0,005	6,00
laterizi forati sp.30 cm rif. 1.1.17	0,300	206,00
intonaco di cemento, sabbia e calce per esterno	0,015	27,00

dati generali	
rigidità dinamica isolante:	10 Mn/m ³
massa sup. intonaco esterno:	10,70 kg/m ²
R _w indice potere fonoisolante parete iniziale (senza isolante):	47 dB
Δ R _w miglioramento dell'indice di potere fonoisolante della parete:	6 dB
indice R_w della parete con isolamento a cappotto	56 dB*

*dato calcolato secondo la UNI EN ISO 12354-1

termok8 fonostop converto

The ideal option for simply and effectively complying with the regulations on energy efficiency and noise pollution. The system includes an insulation panel made of EPS with low dynamic stiffness graphite (a key requirement for excellent acoustic performance), featuring a special grooved pattern that supports a thick external plaster.

material	thickness [m]	surface mass [kg/m ²]
rivatone plus g15	0,002	2,70
klebocem	0,008	8,00
converto fonostop	0,120	2,00
klebocem	0,005	6,00
30cm hollow bricks, ref. 1.1.17	0,300	206,00
cement, sand, and lime plaster for exteriors	0,015	27,00

general information	
dynamic stiffness of insulation:	10 Mn/m ³
ext. plaster surface mass:	10,70 kg/m ²
wall's initial soundproofing capacity index R _w (without insulation):	47 dB
improvement in the wall's soundproofing capacity index Δ R _w :	6 dB
wall's R_w index with external thermal insulation	56 dB*

*data calculated according to Standard UNI EN ISO 12354-1

termok8 fonostop converto

Solución ideal para cumplir con las normativas de eficiencia energética y contaminación acústica. El sistema proporciona como aislamiento un panel EPS con grafito de baja rigidez dinámica (requisito fundamental para un excelente rendimiento acústico), caracterizado por un moleteado especial que soporta un enfoscado externo de alto espesor.

material	espesor [m]	masa superficial [kg/m ²]
rivatone plus g15	0,002	2,70
klebocem	0,008	8,00
converto fonostop	0,120	2,00
klebocem	0,005	6,00
ladrillos perforados esp. 30 cm ref. 1.1.17	0,300	206,00
enfoscado de cemento, arena y cal para exteriores	0,015	27,00

datos generales	
rigidez dinámica aislante:	10 Mn/m ³
masa sup. enfoscado externo:	10,70 kg/m ²
R _w índice del poder de aislamiento acústico de la pared inicial (sin aislante):	47 dB
Δ R _w de mejora del índice del poder de aislamiento acústico de la pared:	6 dB
índice R_w de la pared con aislamiento por capas	56 dB*

*dato calculado según la UNI EN ISO 12354-1



l'applicazione del sistema cappotto

application of the external thermal insulation system

la aplicación de un sistema de aislamiento térmico

La successione dei momenti applicativi costituisce una perfetta concatenazione di fasi da osservarsi con precisione e diligenza e nulla deve essere improvvisato: solo una corretta applicazione può garantire l'alta qualità del sistema.

L'equazione "buona applicazione = alta qualità" coinvolge il direttore lavori, l'applicatore, il produttore e la proprietà dell'edificio.

The sequence of application stages is a perfect chain of events, to be followed precisely and carefully rather than "playing it by ear"; proper application is essential to ensure the high quality of the system.

The "proper application = good quality" equation involves the site manager, the installer, the manufacturer and the building owner.

La sucesión de los tiempos de aplicación es una perfecta cadena de fases que se respetarán con precisión y diligencia, sin dejar nada al azar. Solo una aplicación correcta puede garantizar la alta calidad del sistema.

La ecuación "Aplicación correcta = Alta calidad" involucra al jefe de obra, el aplicador, el fabricante y los propietarios del edificio.



1. posa dei profili di protezione e di contenimento

Provvedere alla preparazione del supporto nel modo più idoneo al caso specifico.

Stabilire le quote "zero" del rivestimento e fissare meccanicamente (a mezzo di appositi tasselli ad espansione, si consiglia un interasse di 30-50 cm) un profilato in lega di alluminio (Profilo di base), per la protezione e il contenimento del sistema, perimetralmente al piano terra dell'edificio ed eventualmente alle pareti degli sfondati.

Posa di eventuali altri profili di contenimento e protezione del sistema secondo le specifiche di progetto (chiusure su parti non isolate, profili sottodavanzali...)

1. application of protection and containment profiles

Prepare the substrate in the most suitable way for the specific case.

Establish the base dimensions of the cladding and mechanically fasten (by means of special expansion anchors, 30-50 cm spacing is recommended) an aluminium alloy profile (base profile), for the protection and containment of the system, around the perimeter of the ground floor of the building and, if necessary, to the walls of recesses.

Application of any other protection and containment profiles for the system according to the project specifications (closures on non-insulated parts, undersill profiles, etc.).

1. colocación de perfiles de protección y contención

Organizar la preparación del soporte de la manera más apropiada para el caso específico.

Establecer las dimensiones "cero" del revestimiento y fijar mecánicamente (mediante tacos de expansión apropiados, se recomienda una distancia entre los ejes de 30-50 cm) un perfil de aleación de aluminio (perfil de base), para la protección y contención del sistema, siguiendo el perímetro de la planta baja del edificio y posiblemente en las paredes de las aberturas.

Instalación de cualquier otro perfil de contención y protección según las especificaciones del proyecto (cierres en piezas no aisladas, perfiles para debajo del alféizar...).

2. posa dello strato isolante

Preparazione con apparecchiatura meccanica della malta adesiva da utilizzare a perfetta omogeneizzazione dopo alcuni minuti di riposo (se in pasta con aggiunta di cemento, se in polvere con l'aggiunta di sola acqua fredda).

L' applicazione del collante può avvenire con due diverse metodologie, assicurando un fissaggio solidale e continuo che non renderà possibile la circolazione di aria tra supporto e pannello. Il collante deve ricoprire almeno il 40% della superficie della lastra.

2. application of the insulation layer

Preparation, with mechanical equipment, of the adhesive mortar, which is to be used when perfectly smooth after standing for a few minutes (if in paste form with the addition of cement, if in powder form with the addition of cold water only).

The adhesive may be applied using two different methods, ensuring a strong and continuous bond that will prevent air from circulating between the substrate and the panel. The adhesive must cover at least 40% of the surface of the slab.

2. colocación de la capa aislante

Preparación con el equipo mecánico del mortero adhesivo que se utilizará para perfeccionar la homogeneización después de unos minutos de reposo (si es en pasta con la adición de cemento, si es en polvo con la adición de agua fría).

El adhesivo se puede aplicar con dos métodos diferentes, asegurando una fijación sólida y continua que no permitirá la circulación de aire entre el soporte y el panel. El adhesivo debe cubrir al menos el 40% de la superficie de la placa.

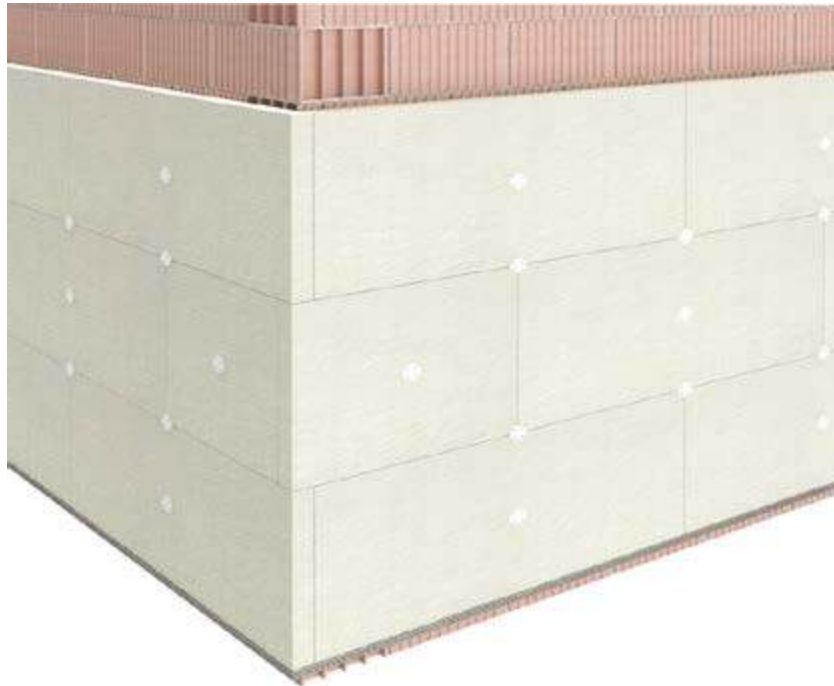

incollaggio a cordolo continuo e punti centrali

È il metodo consigliato perché blocca l'intero perimetro ed il centro della lastra al supporto. È idoneo sia su supporti planari, sia su supporti non troppo regolari, consentendo il livellamento della parete.

continuous perimeter gluing with central points

This is the recommended method because it fastens the entire perimeter and centre of the slab to the substrate. It is suitable on both flat and uneven substrates, permitting the wall to be levelled.

pegado en cordones continuos con puntos centrales

Es el método recomendado porque bloquea todo el perímetro y el centro de la placa en el soporte. Es adecuado tanto en soportes planos como en soportes no demasiado regulares, lo que permite la nivelación de la pared.

E' necessario ricoprire con la colla almeno il 40% della superficie del pannello.

It is necessary to cover at least 40% of the panel's surface with adhesive.

Es necesario cubrir con el adhesivo al menos el 40% de la superficie del panel.

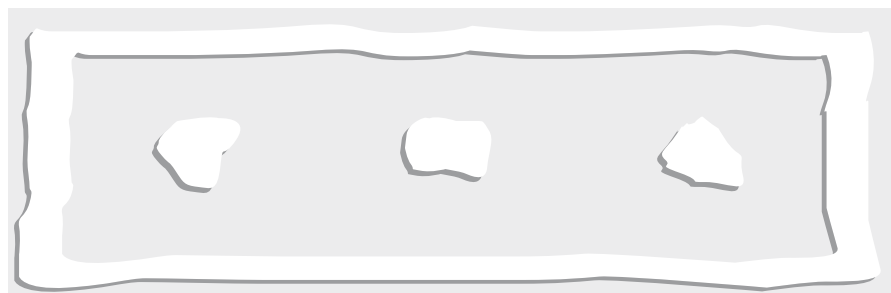

incollaggio a cordolo perimetrale continuo e punti centrali (metodo ottimale)

continuous perimeter gluing with central points (optimal method)

pegado perimetral continuo con puntos centrales (método ideal)

incollaggio a tutta lastra con spatola dentata

È un metodo utilizzabile solo su supporti intonacati molto regolari con ottima planarità; non consente di recuperare avvallamenti o asperità del sottofondo.

full-slab gluing using a serrated spatula

This method can only be used on plastered substrates that are very even and perfectly flat; it does not allow depressions or unevenness in the substrate to be remedied.

pegado a toda placa con llana dentada

Es un método que solo se puede usar en sustratos enfoscados muy regulares con excelente planicidad; no permite recuperar depresiones o irregularidades del sustrato.

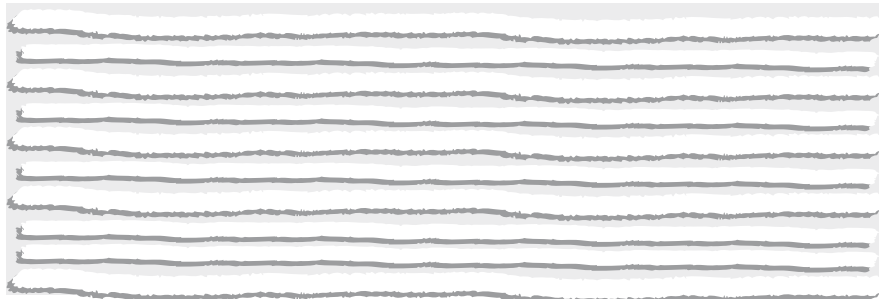

Incollaggio a tutta lastra con spatola dentata (metodo sconsigliato in caso di non ottimale planarità delle superfici)

full-slab gluing using a serrated spatula (this method is not recommended if surfaces are not perfectly flat)

Pegado a toda placa con una llana dentada (este método no se recomienda si las superficies no son perfectamente planas)

incollaggio con proiezione meccanica

In caso di incollaggio con proiezione meccanica la colla viene applicata direttamente sul pannello. L'incollaggio con proiezione meccanica continua può essere realizzato con il metodo a cordolo perimetrale e punti o con il metodo a tutta superficie secondo gli schemi qui a lato.

gluing using a machine

In the case of gluing using a machine, the adhesive is applied directly onto the panel. Gluing using a machine can be carried out using the perimeter with central points method or using the full-surface method as per the diagrams below.

encolado con proyección mecánica

En caso de encolado con proyección mecánica, la cola se aplica directamente sobre el panel. El encolado con proyección mecánica continua puede realizarse mediante cordones perimetrales y puntos o con el método a superficie completa, conforme a los esquemas que se encuentran abajo.

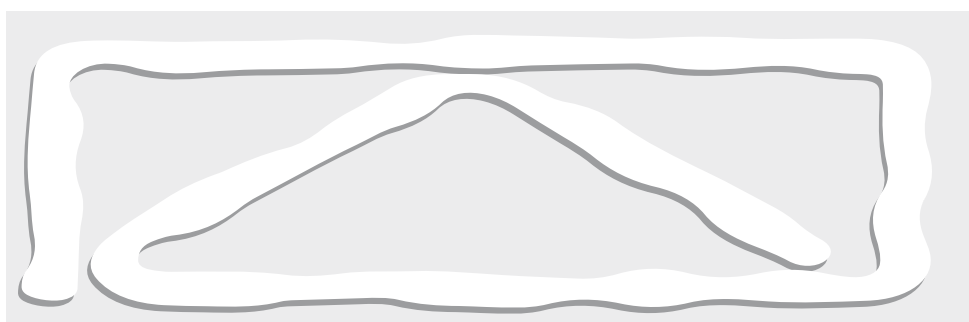
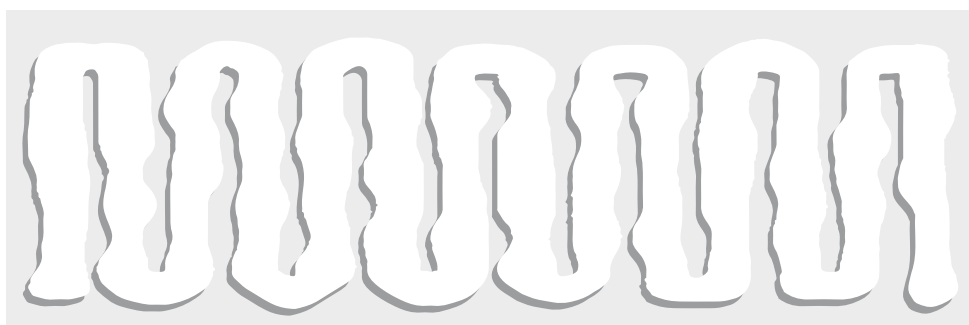

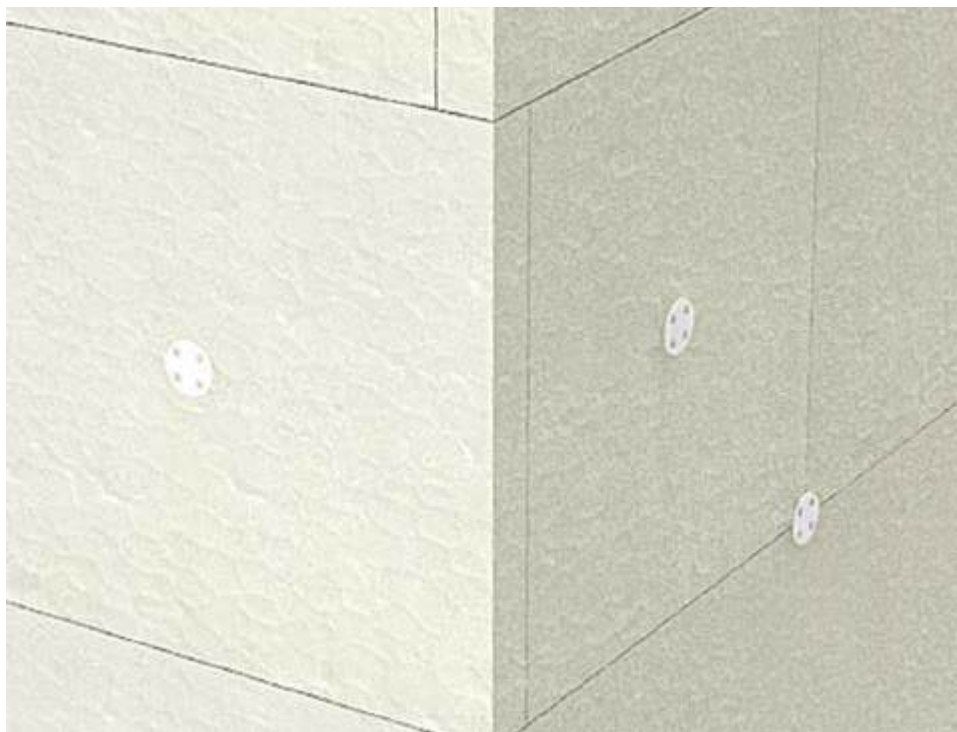

L'applicazione dei pannelli isolanti al supporto (per uno spessore funzionale al calcolo di progettazione) dovrà essere realizzata per fasce orizzontali partendo dal basso e con le fughe verticali sfalsate di almeno 30 cm, perfettamente accostati, le giunzioni non dovranno essere visibili. Riempire eventuali aperture superiori a 2 mm con una porzione di isolante a secco o sigillante poliuretano se l'isolante utilizzato fosse compatibile.

In tutti gli spigoli, le teste dei pannelli isolanti dovranno essere alternate al fine di garantire una corretta distribuzione delle tensioni.

Controllare con frequenza la buona planarità della superficie, in caso contrario procedere con piallatura, levigatura o carteggiatura (asportando la polvere prodotta) per creare un perfetto piano di supporto alla successiva rasatura. La corretta posa dello strato isolante è basilare per assicurare un cappotto di qualità e fondamentale per la sua resa estetica.

Il taglio dei pannelli va eseguito esclusivamente ad angolo retto con attrezzi appropriati, eventuali tagli di porzioni sporgenti vanno eseguiti a collante essiccato.

The insulation panels are to be applied to the substrate (with thickness depending on the design calculation) in horizontal bands starting from the bottom and with the vertical joints staggered by at least 30 cm; the panels must be perfectly aligned, the joints must not be visible. Fill any openings greater than 2 mm with some dry insulation or polyurethane sealant if the insulation used is compatible with it.

At all edges, the heads of the insulation panels must be alternated in order to ensure the proper distribution of stresses.

Frequently check that the surface is completely flat; if it is not, plane, smooth, or sand it (removing the dust produced) to create a perfect substrate for subsequent skimming. The correct application of the insulation layer is essential to ensure a high-quality external thermal insulation system and fundamental to its aesthetic appearance.

Panels must only be cut at right angles with appropriate tools; any cuts of protruding portions must be made after the adhesive has dried.

La aplicación de los paneles aislantes al soporte (para un grosor funcional al cálculo del diseño) debe realizarse en bandas horizontales comenzando desde el fondo y con las juntas verticales desplazadas al menos 30 cm, perfectamente yuxtapuestas, las juntas no deben ser visibles. Rellene cualquier abertura superior a 2 mm con una pieza de aislamiento seco o sellador de poliuretano si el aislamiento utilizado es compatible.

En todos los bordes, las cabezas de los paneles aislantes deben alternarse para garantizar una distribución correcta de las tensiones.

Compruebe con frecuencia la buena planaridad de la superficie; de lo contrario, proceda a cepillar o lijar (eliminar el polvo producido) para crear un plan de soporte perfecto para el sucesivo enrasado. La colocación correcta de la capa aislante es básica para garantizar un sistema de aislamiento térmico de calidad y fundamental para su rendimiento estético.

Los paneles deben cortarse en ángulo recto con las herramientas apropiadas, cualquier corte de las partes sobresalientes debe hacerse con adhesivo seco.

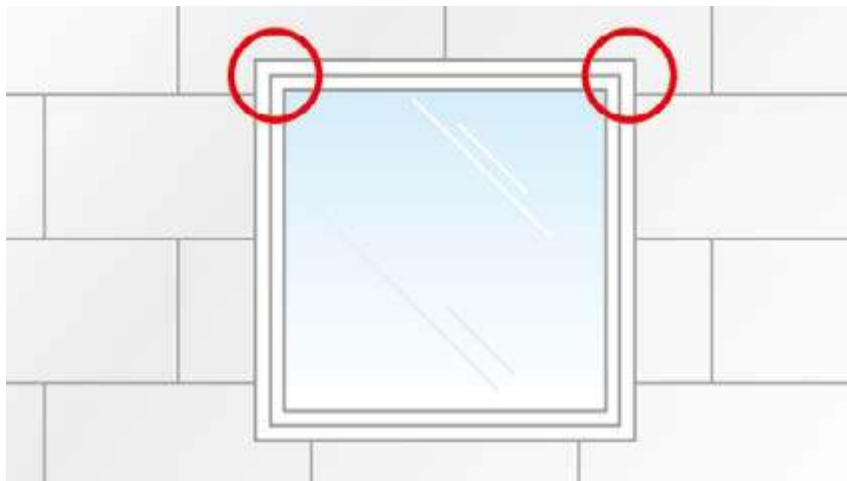

In corrispondenza delle aperture le giunzioni tra pannelli non devono risultare allineate con spalllette, architravi o spigoli delle aperture stesse.

La posa dell'isolante deve rispettare i giunti di dilatazione strutturali e riprenderli con appropriati sistemi di giunzione.

E' nel momento della posa dello strato isolante che si devono prevedere eventuali interruzioni del sistema a cappotto secondo indicazioni previste dai sistemi specifici o dalle dimensioni del fabbricato.

At the openings, the joints between the panels must not be aligned with the stiles, lintels, or edges of the openings themselves.

When applying the insulation, the structural expansion joints must be taken into account, and appropriate jointing systems must be used.

When applying the insulation layer, provision must be made for any gaps in the external thermal insulation system in accordance with the requirements of the specific systems or the dimensions of the building.

En las aberturas, las juntas entre paneles no deben quedar alineadas con las jambas, arquivados o aristas de dicha aberturas.

La colocación del aislamiento debe respetar las juntas de expansión estructurales y reanudarlas con los sistemas de unión apropiados.

En el momento de colocar la capa aislante es necesario prever eventuales interrupciones del sistema de aislamiento térmico de acuerdo con las indicaciones proporcionadas por los sistemas específicos o por el tamaño del edificio.

3. strato d'isolante rinforzato

Per le zoccolature dei fabbricati, porzioni soggette ad urti accidentali, quelle contro terra, nonché quelle che richiedano basso assorbimento d'acqua si consiglia l'utilizzo della speciale lastra isolante a densità maggiorata e a basso assorbimento d'acqua Converto P 200 - Converto EPS 30 G - Perimetro in abbinamento al sistema termok8 utilizzato con identico spessore e conduttività. In alternativa, per migliorare la resistenza agli urti accidentali, utilizzare le speciali lastre isolanti in polistirene: EPS 35 Max R, EPS 31 G Max R. Questi speciali pannelli isolanti, sono caratterizzati da una particolare zigrinatura profonda 5 mm atta ad aumentare la superficie specifica della lastra durante la rasatura e formare continuativi cordoli verticali a "V" progettati per una maggiore resistenza del sistema.

Questa applicazione elimina l'obbligo di estendere le superfici trattate al primo marcapiano disponibile o, se assente, all'uso di cornici o profili per mascherare le antiestetiche giunzioni dovute a spessori di rasatura tra loro diversi: infatti non utilizza rete o collante specifici, diversi da quelli utilizzati nelle superfici non rinforzate.

Le soluzioni per ottenere un sistema termok8 ad elevata resistenza agli urti sono più d'una e tutte di facile applicazione, di risultato sicuro e di aspetto estetico differente: termok8 a.r. max 20 J* - termok8 a.r. max 60 J* - termok8 fonostop converto - termok8 modular big - termok8 modular biostone - termok8 modular facciavista - termok8 modular D.

*Tali sistemi sono corredati da certificato di resistenza all'urto secondo la norma UNI EN 13497 (test svolti presso l'Istituto Giordano).

3. reinforced insulation layer

For building plinths, areas subject to accidental impacts, areas in contact with the ground, as well as areas requiring low water absorption, it is recommended to use the special insulation slab with increased density and low water absorption, Converto P 200 - Converto EPS 30 G - Perimetro in conjunction with the termok8 system used with identical thickness and conductivity. Alternatively, to improve resistance to accidental impacts, use the special polystyrene insulation slabs: EPS 35 Max R and EPS 31 G Max R. These special insulation panels feature a unique 5mm deep grooved pattern, so as to increase the surface area of the slab during skimming and to form continuous horizontal "T" section ridges, designed to make the system stronger.

This application eliminates the need to extend the treated surfaces to the first string course available or, if there is none, the use of cornices or profiles to mask unsightly joints due to different skim coat thicknesses. In fact, it does not use any specific mesh or adhesive different from those used in non-reinforced surfaces.

There are several solutions for obtaining a termok8 system with high impact resistance, all of which are easy to apply, give reliable results, and differ in appearance: termok8 a.r. max 20 J* - termok8 a.r. max 60 J* - termok8 fonostop converto - termok8 modular big - termok8 modular biostone - termok8 modular facciavista - termok8 modular D.

*These systems come with an impact resistance certificate in accordance with standard UNI EN 13497 (tests carried out at Istituto Giordano).

3. capa de aislamiento reforzado

Para los rodapiés de las construcciones, partes expuestas a impactos accidentales, partes en contacto con el suelo, así como las que requieren una baja absorción de agua, se aconseja utilizar la placa aislante especial de densidad aumentada y baja absorción de agua Converto EPS P 200 - Converto EPS 30 G - Perimetro combinado con el sistema termok8 utilizado con el mismo espesor y conductividad. Alternativamente, para mejorar la resistencia al impacto accidental, utilice las placas aislantes especiales de poliestireno: EPS 35 Max R, EPS 31 G Max R. Estos paneles aislantes especiales se caracterizan por un especial moleteado de 5 mm de profundidad que puede aumentar la superficie específica de la placa durante el enrasado y formar cordones horizontales continuos en "T" proyectados para una mayor resistencia del sistema.

Esta aplicación elimina la necesidad de extender las superficies tratadas hasta el primer marcapisos disponible o, si no lo hubiera, de tener que utilizar marcos o perfiles para enmascarar las antiestéticas juntas debidas a espesores de enrasado distintos entre si.: en efecto no utiliza mallas o adhesivos específicos, distintos de los utilizados en superficies no reforzadas.

Las soluciones para obtener un sistema termok8 de elevada resistencia a los choques son más de una y todas de fácil aplicación, de resultado seguro y de aspecto estético diferente: termok8 a.r. max 20 J* - termok8 a.r. max 60 J* - termok8 fonostop converto - termok8 modular big - termok8 modular biostone - termok8 modular facciavista - termok8 modular D.

*Estos sistemas van acompañados de un certificado de resistencia al impacto según la norma UNI EN 13497 (pruebas realizadas en el Instituto Giordano).

4. fissaggio meccanico dello strato isolante

Inserimento di appositi tasselli ad espansione in ragione di n° 6 al m² (tassellatura normale) o n° 8/10/12 (tassellatura rinforzata) a seconda delle condizioni ambientali, stato del supporto, altezza e secondo le prescrizioni indicate nell'APPENDICE B della norma UNI TR 11715:2018

Il dimensionamento della lunghezza del tassello dovrà avvenire in funzione dello spessore del pannello isolante, della stratigrafia della parete e della profondità di ancoraggio del tassello (consultare la scheda tecnica del tassello).

Si consiglia di aumentare il numero dei tasselli nelle zone perimetrali dell'edificio (vedi schemi tassellatura).

L'esecuzione dei fori per i tasselli deve essere eseguita esclusivamente a collante indurito (2-3 giorni); fanno eccezione i materiali isolanti particolarmente pesanti quando si renderà necessario l'inserimento di un primo tassello centrale al momento della posa del pannello per sorreggerne il peso (seguirà normale tassellatura a collante essiccato).

E' necessario utilizzare punte di trapano con diametro appropriato ed utilizzare trapani perforatori in modalità a percussione solo in caso di supporto in calcestruzzo o mattoni pieni.

Il tassello deve essere montato con il piatto a filo del pannello isolante o, nel caso di tasselli a scomparsa, con l'apposito accessorio di chiusura (copritassello o tappo isolante).

Ogni singolo tassello deve essere adeguatamente in presa: diversamente va asportato avendo cura d'isolare le cavità formatesi con idoneo sigillante poliuretano e ricollocato nelle vicinanze. L'operazione richiede la massima cura al fine di evitare modificazioni della planarità della superficie.

Eventuali piccoli dislivelli della superficie isolante dovranno essere corretti con carteggiatura delle superfici, salvo indicazioni diverse per isolanti particolari.

4. mechanical anchoring of the insulation layer

Insert 6 special expansion anchors per m² (normal anchoring) or 8 anchors per m² (reinforced anchoring) depending on environmental conditions, substrate condition, and height.

The length of the anchor must be sized according to the thickness of the insulation panel, the layering of the wall, and the depth of the anchor (see the anchor's technical data sheet).

It is advisable to increase the number of anchors at the perimeter of the building (see anchoring diagrams).

The holes for the anchors must only be drilled after the adhesive has hardened (2-3 days); an exception is made for particularly heavy insulating materials when it becomes necessary to insert an initial central anchor when the panel is installed to support its weight (normal anchoring will then be performed after the adhesive has dried).

Appropriate diameter drill bits must be used, and drills must only be used in percussion mode in the case of concrete or solid brick substrates.

The anchor must be fitted with the plate flush with the insulation panel or, in the case of concealed anchors, with the appropriate closing component (anchor cap or insulating plug).

Every single anchor must be adequately set. If any anchor is not adequately set, it must be removed and repositioned nearby after carefully sealing any resulting holes using a suitable polyurethane sealant. This operation requires the utmost care in order to avoid causing any changes to the flatness of the surface.

Any small unevenness in the insulation surface must be corrected by sanding the surface, unless otherwise specified for particular insulations.

4. fijación mecánica de la capa aislante

Introducción de tacos de expansión específicos a razón de 6 por m² (distribución normal) o de 8 por m² (distribución reforzada) en función de las condiciones ambientales, del estado del soporte, y la altura.

El cálculo de la longitud del taco deberá hacerse en función del espesor del panel aislante, de la estratigrafía de la pared y de la profundidad de anclaje del taco (consultar la ficha técnica del taco).

Es aconsejable aumentar el número de tacos en las áreas perimetrales del edificio (ver esquemas de distribución de tacos).

Los agujeros de perforación se deben hacer exclusivamente con adhesivo endurecido (2-3 días); una excepción son los materiales aislantes particularmente pesados cuando será necesario insertar un primer taco central cuando el panel se coloque para soportar su peso (una vez que el adhesivo se haya secado, se procederá a la distribución normal de tacos).

Es necesario usar brocas con un diámetro apropiado y usar taladros de percusión solo en caso de soporte de hormigón o ladrillos macizos.

El taco debe montarse con la placa al ras del panel aislante o, en el caso de tacos ocultos, con el accesorio de cierre adecuado (cubretaco o tapón aislante).

Cada taco debe sujetarse correctamente: de lo contrario, debe retirarse teniendo cuidado de aislar las cavidades formadas con un sellador de poliuretano adecuado y ubicados cerca. La operación requiere el máximo cuidado para evitar cambios en la planicidad de la superficie.

Cualquier pequeña irregularidad de la superficie aislante se debe corregir lijando las superficies, a menos que se indique lo contrario para aislantes específicos.

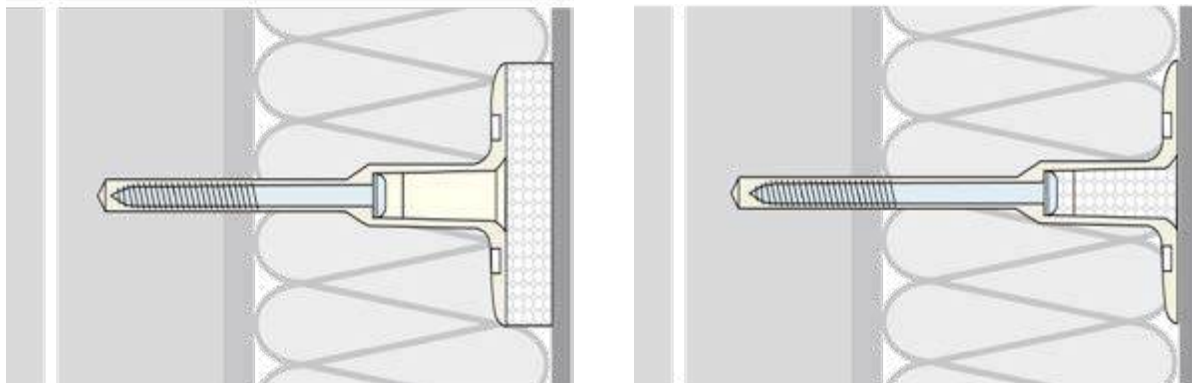

schemi di tassellatura sulle
superfici dell'edificio

diagrams for application of anchors
on building surfaces

esquema de distribución de tacos
en las superficies del edificio

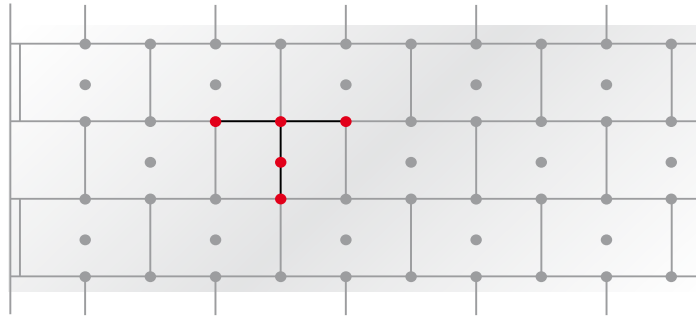

schema di applicazione tasselli a "T" (6 tasselli/m²)

diagram for application of T-anchors (6 anchors/m²)

esquema de aplicación de los tacos en "T" (6 tacos/m²)

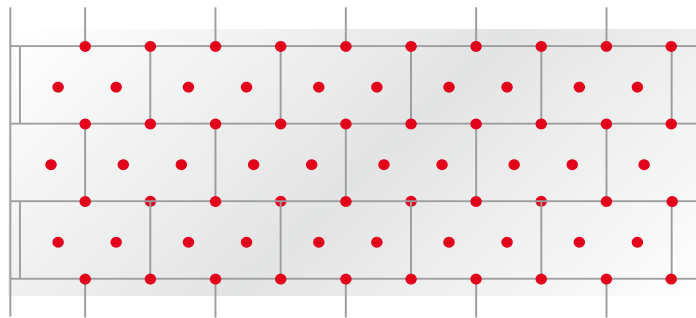

schema tassellatura rinforzata (8 tasselli/m²)

diagram for application of reinforced anchors (8 anchors/m²)

esquema reforzado (8 tacos/m²)

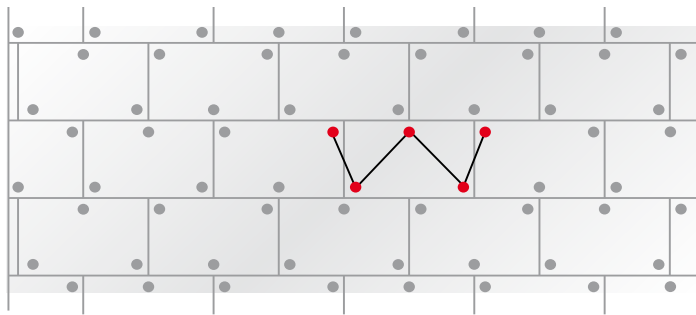

schema di applicazione tasselli a "W" per materiali
fibrosi (6 tasselli/m²)

diagram for application of W-anchors for fibrous
materials (6 anchors/m²)

esquema de aplicación de tacos en "W" en material
fibroso (6 tacos/m²)

schemi di tassellatura sugli spigoli dell'edificio

diagrams for application of anchors on building corners

esquemas de distribución de tacos en esquinas

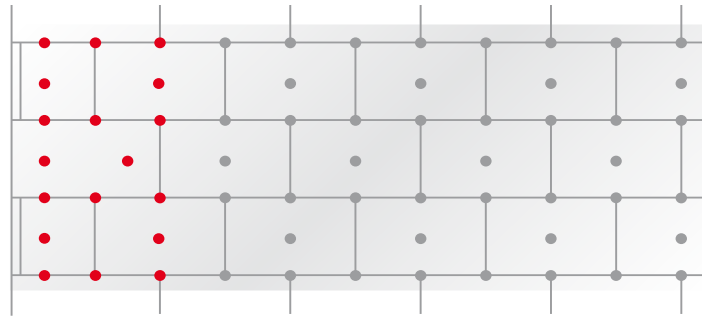

schema di applicazione tasselli a "T" (6 tasselli/m²) con schema tassellatura degli spigoli (8 tasselli/m²)

diagram for application of T-anchors (6 anchors/m²) with diagram for application of anchors on corners (8 anchors/m²)

esquema de aplicación de tacos en "T" (6 tacos/m²) con esquema para esquinas (8 tacos/m²)

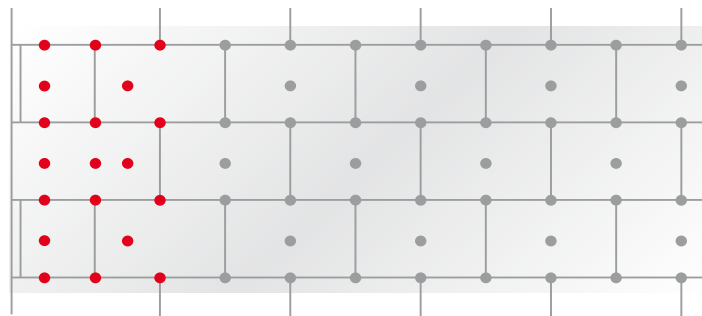

schema di applicazione tasselli a "T" (6 tasselli/m²) con schema tassellatura degli spigoli (10 tasselli/m²)

diagram for application of T-anchors (6 anchors/m²) with diagram for application of anchors on corners (10 anchors/m²)

esquema de aplicación de tacos en "T" (6 tacos/m²) con esquema para esquinas (10 tacos/m²)

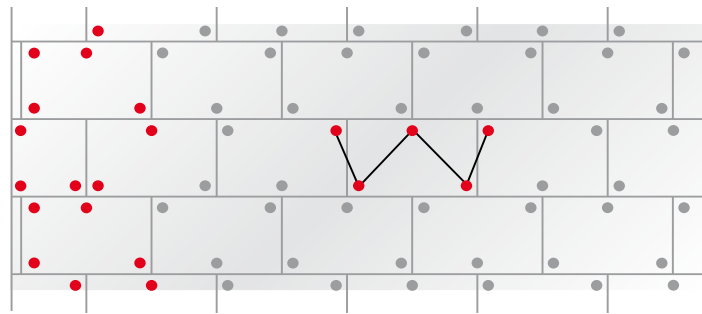

schema di applicazione tasselli a "W" (6 tasselli/m²) con schema tassellatura degli spigoli (8 tasselli/m²)

diagram for application of W-anchors (6 anchors/m²) with diagram for application of anchors on corners (8 anchors/m²)

Esquema a "W" (6 tacos/m²) con esquema para esquinas (8 tacos/m²)

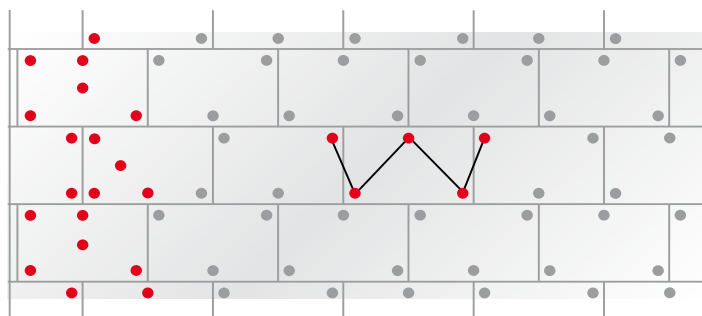

schema di applicazione tasselli a "W" (6 tasselli/m²) con schema tassellatura degli spigoli (10 tasselli/m²)

diagram for application of W-anchors (6 anchors/m²) with diagram for application of anchors on corners (10 anchors/m²)

esquema de aplicación de tacos en "W" (6 tacos/m²) con esquema para esquinas (10 tacos/m²)

5. protezione e rinforzo dello strato isolante

Applicazione con malta adesiva dei profili paraspigoli in corrispondenza di tutti i risvolti per la piombatura di spigoli e loro protezione meccanica.

Applicazione con malta adesiva di eventuali altri profili accessori, ad esempio giunti di dilatazione (non è consentito l'uso di profili zincati o in ferro verniciato e l'applicazione mediante chiodatura).

Applicazione di armature diagonali, in corrispondenza di tutti gli angoli delle aperture, realizzate applicando strisce di rete delle dimensioni di circa 20x40 inclinate di 45° rispetto all'asse perpendicolare delle aperture stesse, al fine di sopportare la concentrazione di tensioni senza indurre microlesioni superficiali.

In caso di isolanti fibrosi o in sughero, si consiglia la stesura di un primer acrilico sull'intera superficie (che risulta invece obbligatoria nell'utilizzo del calcio silicato) al fine di agevolare la successiva stesura e lavorabilità del rasante.

Nel caso in cui gli isolanti indicati risultino particolarmente irregolari, si rende opportuna una rasatura preliminare di compensazione su tutta la superficie isolata.

5. protection and reinforcement of the insulation layer

Attach corner guards with adhesive mortar on all corners for edge sealing and mechanical protection.

Use adhesive mortar to apply any other fittings, e.g. expansion joints (galvanised or painted iron profiles and application by nailing is not permitted).

Apply diagonal reinforcements at the corners of all openings, by applying strips of mesh measuring approximately 20x40 cm at a 45° angle to the perpendicular axis of the openings, in order to withstand the concentration of stresses without causing fine fissuring on the surface.

In the case of fibrous or cork insulation, it is advisable to apply an acrylic primer over the entire surface (which is obligatory when using calcium silicate) in order to facilitate the subsequent application and workability of the skim coat.

If the insulation is particularly uneven, the entire insulated surface will need to be skimmed beforehand to even it out.

5. protección y refuerzo de la capa aislante

Aplicación con mortero adhesivo de los perfiles de protección para esquinas en correspondencia con todas las solapas para la fontanería en bordes y su protección mecánica.

Aplicación con mortero adhesivo de cualquier otro perfil accesorio, por ejemplo juntas de expansión (no se permite el uso de perfiles de hierro galvanizado o pintado o la aplicación mediante remachado).

Aplicación de refuerzos diagonales, para todos los ángulos en aberturas, realizados mediante la aplicación de tiras de malla de dimensiones de aproximadamente 20x40 inclinadas 45° con respecto al eje perpendicular de las mismas, para contrarrestar tensiones y evitar microlesiones superficiales.

Para materiales aislantes fibrosos o de corcho, es aconsejable aplicar una imprimación acrílica sobre toda la superficie (obligatoria en el uso de silicato cálcico) para facilitar la colocación posterior de la capa de mortero de enrasado.

En caso de que los aislantes indicados sean particularmente irregulares, se requiere un enrasado de compensación preliminar en toda la superficie aislada.



6. intonaco sottile armato

Applicazione sullo strato isolante di malta rasante e successivo annegamento, a malta ancora fresca, di apposita rete in tessuto di fibra di vetro apprettato, antialcalina e anti demagliante (Armatex C1, Armatex C1M o Armatex C1R).

La rete deve essere annegata a metà rasatura, oppure nel terzo esterno in caso applicazioni a 3 mani.

La sovrapposizione dei teli di rete, applicati in senso verticale, dovrà essere di almeno 10 cm e di 15 cm in prossimità dei risvolti, se protetti con profili paraspigoli privi di rete incorporata.

Annegare la rete in modo uniforme, non asportando il rasante ma ridistribuendolo su tutta la superficie evitando la formazione di eventuali pieghe che non devono mai essere eliminate ricorrendo al taglio della rete.

In corrispondenza degli spigoli, se non fossero stati impiegati profili con rete incorporata, si dovranno risvoltare circa 15 cm di rete da entrambi i lati. Per le zoccolature dei fabbricati e le zone soggette ad urti accidentali si consiglia l'uso di apposita rete rinforzata o sistemi termok8 a.r. max 20 J o termok8 a.r. max 60 J.

Lo strato armato verrà completato con una successiva rasatura a completo essiccamento del primo strato di malta a protezione e completa copertura della rete.

6. reinforced thin plaster

Asized, anti-alkaline and unravel-proof glass-fibre mesh (Armatex C1, Armatex C1M, or Armatex C1R) is to be applied to the skimming mortar insulation layer and then embedded, while the mortar is still fresh.

The mesh must be embedded at the mid-point of the skim coat, or in the outermost third of it in the case of 3-coat applications.

The overlap of the mesh sheets, which are applied vertically, must be at least 10 cm, and 15 cm near corners, if they are protected with corner guards with no mesh embedded.

Embed the mesh evenly, without removing the skim coat but rather redistributing it over the entire surface, avoiding the formation of any folds, which must never be eliminated by cutting the mesh.

Approximately 15 cm of mesh should be folded over on both sides at the corners, unless profiles with incorporated mesh are used. For buildings plinths and points exposed to accidental impact, it is recommended to use reinforced mesh or termok8 a.r. max 20 J or termok8 a.r. max 60 J systems.

The reinforced layer is to be completed with another skim coat after the first layer of mortar is completely dry, in order to protect and completely cover the mesh.

6. enfoscado fino armado

Aplicación sobre la capa aislante de mortero de enrasado y sucesiva aplicación, con el mortero aún fresco, de una malla especial de tejido de fibra de vidrio aprestado, antialcalina y antidesmallante (Armatex C1, Armatex C1M o Armatex C1R).

La malla debe ser aplicada a mitad del enrasado, o en el tercio exterior en el caso de 3 manos.

La superposición de los tejidos de malla, aplicados verticalmente, debe ser de al menos 10 cm y 15 cm cerca de las solapas, si están protegidos con perfiles de protección de esquina sin una malla incorporada.

Sumergir la malla de manera uniforme, sobre la capa de enrasado, redistribuyéndola sobre toda la superficie, evitando la formación de pliegues que nunca se deben eliminar cortando la malla.

En las esquinas, si los perfiles con una malla incorporada no se han utilizado, se pueden voltear unos 15 cm de red desde ambos lados. Para los rodapiés de los edificios y en zonas sujetas a golpes accidentales, se recomienda el uso específico de malla reforzada o de sistemas termok8 a.r. max. 20 J o termok8 a.r. max 60 J.

La capa armada se completará con un posterior enrasado una vez completamente seca la primera capa de mortero, para proteger y cubrir completamente la malla.

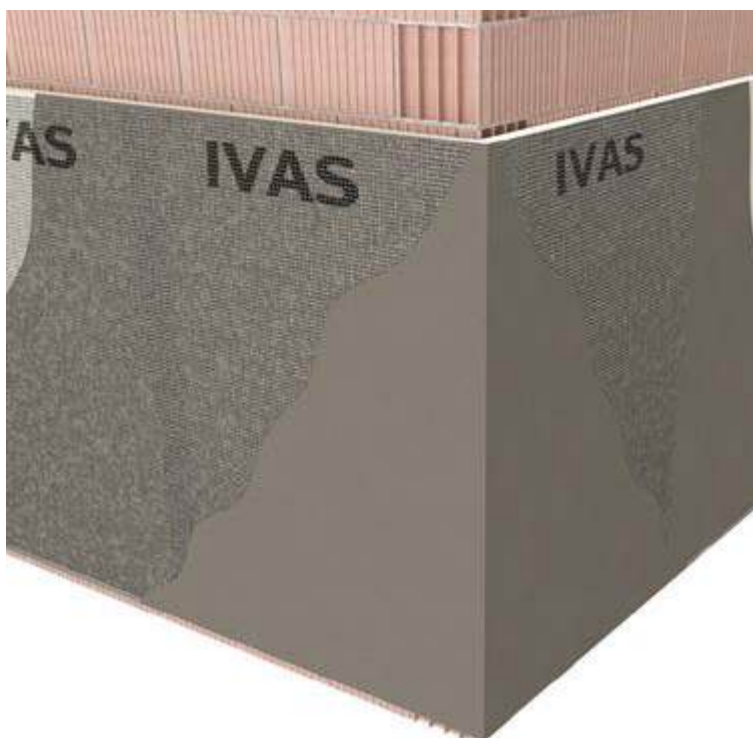

7. protezione del sistema

Applicazione delle sigillature necessarie a garantire la durabilità del sistema con apposito sigillante poliuretano intumescente sovraverniciabile (Sigil Pol) a copertura della guarnizione adesiva precedentemente posata. Quest'ultima è supporto funzionale alla sigillatura elastica e alla compensazione dei movimenti di ritiro e dilatazione del sistema isolante.

7. protecting the system

Seal with suitable intumescent overpaintable polyurethane sealant (Sigil Pol) to cover the adhesive gasket previously fitted, to ensure the durability of the system. The adhesive gasket provides functional support for elastic sealing and compensates for any contraction and expansion in the insulation system.

7. protección del sistema

Aplicación de los sellados necesarios para garantizar la durabilidad del sistema con un sellador de poliuretano intumescente que admite recubrimiento de pintura (Sigil Pol) para cubrir el sellado adhesivo previamente colocado. Este último es un soporte funcional para el sellado elástico y para la compensación de los movimientos de contracción y dilatación del sistema aislante.

8. rivestimento di finitura

Il rivestimento finale (intonaco di finitura) serve a garantire la sufficiente protezione dagli agenti atmosferici, e a contribuire alle resistenze meccaniche superficiali, integrando l'intonaco di base. A tale scopo deve essere garantito uno spessore minimo, mediante la scelta di rivestimenti a spessore con granulometria uguale o superiore a 1.5 mm applicati in mano unica, o, con granulometria inferiore prevedendo, in quest'ultimo caso, due mani di posa o aumentando lo spessore della rasatura armata ad almeno 5mm"

La realizzazione dello strato di finitura deve avvenire a completa stagionatura dell'intonaco armato. Prima di procedere con l'applicazione si consiglia la verifica della temperatura sia dell'ambiente che del supporto, che deve essere compresa fra i +5°C ed i +35°C.

I rivestimenti di finitura sono da applicare direttamente sullo strato di intonaco, con lavorazioni appropriate al tipo di prodotto, operare seguendo le indicazioni contenute nelle relative schede tecniche.

Eventuali mani di fondo sono funzionali alle condizioni climatiche di applicazione, al colore scelto e alla granulometria utilizzata. Nel caso di tinte forti si consiglia l'applicazione preliminare di una mano di fissativo idoneo alla finitura scelta al fine di massimizzare la tenuta del colore nel tempo.

Una lavorazione fresco su fresco evita il rischio di variazioni cromatiche e strutturali della superficie. Per evitare stacchi visibili tra i piani dell'impalcatura si consiglia di lavorare in modo sfalsato sopra e sotto il ponteggio. In alternativa, per ridurre il rischio di stacchi visibili, si può prevedere una interruzione della finitura tra i livelli corrispondenti ai vari piani, inserendo ad esempio nastri, lesene, profili. Le pause di lavoro dovrebbero corrispondere al completamento di superfici intere. L'utilizzo di sufficiente manodopera, in numero adeguato alle esigenze del cantiere e alle condizioni climatiche di esercizio, evita il rischio di giunti visibili.

La lavorazione deve essere programmata evitando, durante tutta la sua stesura ed essiccazione, fenomeni climatici quali, pioggia, nebbia, e elevata umidità (U.R. \leq 80%), radiazione solare eccessiva e forte vento. Occorre schermare i ponteggi durante tutte le fasi di lavorazione e almeno per i 2 giorni successivi per evitare variazioni cromatiche dovute all'insolazione e agli agenti atmosferici. Per la realizzazione di una facciata si raccomanda di utilizzare materiale dello stesso lotto, al fine di evitare contrasti cromatici possibili in lotti di partiture differenti.

I rivestimenti di finitura e le pitture utilizzate a protezione dei sistemi a cappotto, sono caratterizzate da una specifica formulazione che le rende resistenti alla formazione di alghe e funghi, che possono insorgervi a causa delle particolari condizioni d'esercizio che vi si innescano.

8. finishing coat

The purpose of the final coat (finishing plaster) is to ensure sufficient protection against the weather, and to contribute to the surface mechanical resistance by supplementing the base plaster. To this end, a minimum thickness must be guaranteed, by choosing thick coats with a particle size greater than or equal to 1.5 mm applied in a single coat or, with a smaller particle size, providing, in the latter case, two coats or increasing the thickness of the shaving at least 5mm". The finishing coat must be applied after the reinforced plaster is completely cured. Before proceeding with the application, it is recommended to check the ambient and substrate temperatures, which must be between +5°C and +35°C.

Finishing coats should be applied directly onto the plaster layer with methods appropriate to the type of product, working in accordance with the information contained in the relevant technical data sheets.

Any base coats depend on the weather conditions of application, the colour chosen, and the particle size used. In the case of strong colours, the preliminary application of a coat of fixative suitable for the chosen finish is recommended in order to maximise colour fastness over time.

Using a wet-on-wet technique avoids the risk of colour and structural changes in the surface. To prevent visible breaks between the levels of the scaffolding, it is advisable to work in a staggered manner above and below the scaffolding. Alternatively, in order to reduce the risk of visible breaks, the finish between the levels corresponding to the various floors can be interrupted, e.g. by inserting strips, pilasters, or profiles. Work breaks should be taken in correspondence with the completion of entire surfaces. The use of sufficient manpower, appropriate to the needs of the site and the weather conditions, avoids the risk of visible joints.

The work must be planned so as to avoid weather conditions such as rain, fog, and high humidity (R.H. \leq 80%), excessive sunlight, and strong wind throughout the entire application and drying process. Scaffolding must be covered during all work phases and for at least 2 days afterwards to avoid colour changes due to sunlight and weather conditions. When constructing a façade, it is recommended to use material from the same batch in order to prevent possible colour differences between different batches.

Finishing coats and paints used for the protection of external thermal insulation systems are characterised by a specific formulation that makes them resistant to the growth of algae and mould, which can occur due to the particular operating conditions.

8. revestimiento de acabado

El revestimiento final (enfoscado de acabado) sirve para garantizar la protección suficiente frente a los agentes atmosféricos, y a contribuir a las resistencias mecánicas superficiales, complementando el enfoscado de base. Con esa finalidad se debe garantizar un espesor mínimo, mediante la elección de revestimientos de espesor con granulometría igual o superior a 1.5 mm aplicados en una sola mano, o con granulometría inferior previendo, en este último caso, dos manos de colocación o aumentando el espesor del afeitado armado a por lo menos 5mm.

La realización de la capa de acabado debe efectuarse una vez completamente fraguado el enfoscado armado. Antes de proceder con la aplicación se aconseja comprobar la temperatura, tanto ambiental como del soporte, que debe estar entre +5 °C y +35 °C.

Los revestimientos de acabado deben aplicarse directamente en la capa de enfoscado, con elaboraciones adecuadas para el tipo de producto; proceder siguiendo las indicaciones recogidas en las fichas técnicas correspondientes.

Las posibles manos de fondo son funcionales a las condiciones climáticas de aplicación, al color elegido, y a la granulometría utilizada. En caso de tintes fuertes, se aconseja la aplicación preliminar de una mano de fijador adecuado para el acabado elegido a fin de optimizar al máximo que el color se mantenga con el tiempo.

Una elaboración fresco sobre fresco evita el riesgo de variaciones cromáticas y estructurales de la superficie. Para evitar desconexiones visibles entre los planos del andamiaje, se aconseja trabajar de forma alternada, por encima y por debajo del andamio. Como alternativa, para reducir el riesgo de desprendimientos visibles, se puede prever una interrupción del acabado entre los niveles correspondientes a los distintos planos, introduciendo, por ejemplo, cintas, pilastras, perfiles. Las pausas de trabajo deben hacerse coincidir con el completarse de superficies enteras. El uso de mano de obra suficiente, en número adecuado a las necesidades de la obra y a las condiciones climáticas de ejercicio, evita el riesgo de juntas visibles.

La elaboración debe programarse evitando, durante todo el proceso de extensión y secado, fenómenos climáticos como lluvia, niebla y niveles de humedad altos (H.R. \leq 80%), radiación solar excesiva y vientos fuertes. Hay que proteger los andamios durante todas las fases de elaboración y al menos los 2 días siguientes para evitar variaciones cromáticas debidas a la exposición al sol y a los agentes atmosféricos. Para la realización de una fachada se recomienda utilizar material del mismo lote, a fin de evitar contrastes cromáticos que pueden darse con materiales procedentes de lotes distintos.

Los revestimientos de acabado y las pinturas utilizadas para proteger los sistemas por capas, se caracterizan por una formulación específica que las hace resistentes a la formación de algas y hongos que pueden surgir a causa de las particulares condiciones de uso que se activan.

Nella scelta del colore dei rivestimenti di finitura e delle eventuali pitture protettive dei sistemi a cappotto è necessario considerare l'indice di riflessione alla luce I.R.

L'indice di riflessione è un'unità di misura della riflessione della luce solare (irraggiamento) (bianco = I.R.100%; nero = I.R. 0%). Un elevato valore di I.R. corrisponde ad un'elevata riflessione della luce solare e conseguentemente un ridotto assorbimento solare. Per evitare un forte surriscaldamento del Sistema ETICS, che indurrebbe deformazioni e tensioni causando danni superficiali al sistema, è stato quindi determinato un valore di I.R. limite del 20%. Se inferiore è necessario affidarsi alla tecnologia specifica **reflect**.

Per superfici esposte a forte irraggiamento solare (esposizione a Sud o Ovest) o in zone climatiche con limite di I.R. (zone climatiche A, B, C, alta montagna, zone con riverbero, per esempio fronte mare o corsi d'acqua) o con spessori di isolante elevati, è consigliabile un aumento del valore di I.R.

Grazie alle tecnologie **plus, reflect, strong, dry, clean** presenti in gamma, i rivestimenti di finitura e le pitture protettive IVAS preservano e proteggono le superfici nel tempo, garantendo un'ampia gamma cromatica senza limiti d'intensità o saturazione delle tinte, assicurando una progettazione del colore in assoluta tranquillità e libertà creativa.

When choosing the colour of the finishing coats and any protective paints for external thermal insulation systems, the light reflection index (IR) must be taken into consideration.

The reflection index is a unit of measurement of the reflection of sunlight (white = IR 100%, black = IR 0%). A high IR value corresponds to high reflection of sunlight and consequently lower solar absorption. To avoid severe overheating of the ETICS System, which would lead to deformations and stresses and thus surface damage to the system, a limit IR value of 20% was set. If lower than this figure, it would be necessary to rely on **reflect** technology.

For surfaces exposed to strong sunlight (southern or western exposure) or in climate zones with an IR limit (climate zones A, B, C, high mountain areas, areas with glare, e.g. seafronts or watercourses) or with high insulation thicknesses, it is advisable to increase the IR value.

Thanks to the **plus, reflect, strong, dry, and clean** technologies available in its product range, IVAS finishing coats and protective paints preserve and protect surfaces over time, providing a wide colour range with no limits on colour intensity or saturation, thus ensuring colour design with absolute peace of mind and total creative freedom.

En la elección del color de los revestimientos de acabado y, en su caso, de las pinturas protectoras de los sistemas por capas es necesario considerar el índice de reflexión a la luz I.R.

El índice de reflexión es una unidad de medida de la reflexión de la luz solar (irradiación) (blanco = I.R. 100 %; negro = I.R. 0 %). Un elevado valor de I.R. corresponde a un alto nivel de reflexión de la luz solar y, por consiguiente a una reducida absorción solar. Para evitar un fuerte sobrecalentamiento del Sistema SATE, que induciría deformaciones y tensiones causando daños superficiales al sistema, se ha determinado un valor de I.R. límite del 20 %. Si es inferior, es necesario recurrir a la tecnología específica **reflect**.

Para superficies expuestas a fuerte irradiación solar (exposiciones al Sur o al Oeste) o en zonas climáticas con límite de I.R. (zonas climáticas A, B, C, alta montaña, zonas con reverberación, por ejemplo frente al mar o a cursos de agua) o con elevados espesores de aislante, se aconseja un aumento del valor del I.R.

Gracias a las tecnologías **plus, reflect, strong, dry, clean** de nuestra gama, los revestimientos de acabado y las pinturas protectoras IVAS preservan y protegen las superficies frente al paso del tiempo, garantizando una amplia gama cromática sin límites de intensidad o saturación de los tintes, asegurando al proyecto de color la más absoluta tranquilidad y libertad creativa.

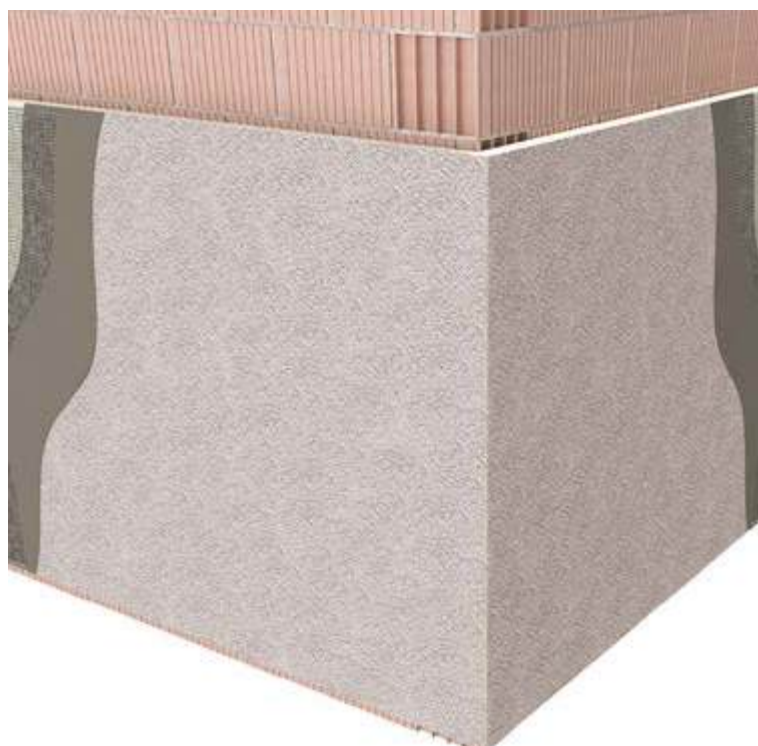



reflect

tecnologia reflect: rivestimenti continui e pitture specificatamente formulati con pigmenti ad alto TSR (Total Solar Reflect) in grado di riflettere la radiazione solare e realizzare finiture scure, anche nere, su cappotto termico limitando il surriscaldamento eccessivo della superficie e minimizzando i rischi di decolorazione nel tempo.

reflect technology: continuous coatings and paints specifically formulated with BASF's high TSR (Total Solar Reflect) pigments able to reflect sunlight and produce dark, even black, surfaces on external thermal insulation systems, thus limiting excessive surface heating and minimising the risk of fading over time.

tecnología reflect: revestimientos continuos y pinturas específicamente formulados con pigmentos BASF de alto TSR (Total Solar Reflect) capaces de reflejar la radiación solar y proporcionar acabados oscuros, incluso negros, sobre sistema térmico por capas, limitando el excesivo calentamiento de la superficie y reduciendo al mínimo los riesgos de decoloración con el paso del tiempo.



strong

tecnologia strong: formulazione che minimizza i rischi di decolorazione nel tempo. Per pitture e rivestimenti di facciata dai colori intensi e tono estremamente vivo.

strong technology: formulation that minimizes the risk of fading over time. Formulated for façade paints and coatings with intense colours and extremely lively tone.

tecnología strong: formulación particular que minimiza los riesgos de decoloración en el tiempo. Para pinturas y revestimientos de fachada con colores intensos y tonos extremadamente vivos.



dry

tecnologia dry: formulazione unica a effetto barriera idrofobizzante, impenetrabile agli agenti atmosferici inquinanti. Minimizza l'assorbimento d'acqua e garantisce un celere deflusso di pioggia e rugiada dilavando le impurità. Per pitture e rivestimenti di facciata sempre asciutti, sani e puliti nel tempo.

dry technology: unique formulation with a hydrophobic barrier effect, impenetrable to atmospheric pollutants. It minimises water absorption and ensures a rapid outflow of rain and dew by washing away impurities. Formulated for façade paints and coatings in order to keep them dry, healthy and clean over time.

tecnología dry: formulación única con efecto barrera hidro-repelente, impenetrable a los agentes atmosféricos contaminantes. Reduce al mínimo la absorción de agua y asegura una salida rápida de lluvia y rocío eliminando las impurezas. Para pinturas y revestimientos de fachada siempre secos, sanos y limpios con el tiempo.



clean

tecnologia clean: nanotecnologia a effetto fotocatalitico ossidante e potere autopulente in grado di decomporre le sostanze organiche a contatto con le superfici. Per pitture e rivestimenti di facciata sempre puliti e idonei al mantenimento dei colori molto chiari, in svariate texture granulometriche.

clean technology: nanotechnology with photo-catalytic oxidising effect and self-cleaning power capable of decomposing organic substances in contact with surfaces. Formulated for façade paints and coatings in order to keep them clean; suitable to maintain very light colours, in various grain sizes.

tecnología clean: nanotecnología con efecto oxidante fotocatalítico y poder de autolimpieza capaz de descomponer sustancias orgánicas en contacto con las superficies. Para pinturas y revestimientos de fachada siempre limpios y adecuados para mantener colores muy claros, en varias texturas.

decorativi della collezione Texture Design, superfici e rivestimenti materici ad alto valore estetico per le architetture di facciata. In questo caso assicurare uno spessore complessivo di rasatura armata non inferiore a 6 mm.

decorative finishes from the Texture Design collection: highly attractive textured surfaces and coatings for façade architecture. In this case, ensure an overall thickness of the reinforced skim coat of no less than 6 mm.

decorativos de la colección Texture Design, superficies y revestimientos matéricos de alto valor estético para las arquitecturas de fachada. En este caso, asegurar un espesor total del enrasado armado no inferior a 6 mm.

video tutorial applicazione **termok8®**: canale YouTube Gruppolve Academy
tutorial video on the application of **termok8®**: YouTube channel Gruppolve Academy
vídeo tutorial de aplicación de **termok8®**: canal de YouTube Gruppolve Academy

complesso residenziale, **termok8®** design con finitura texture effetto legno, rimini, it



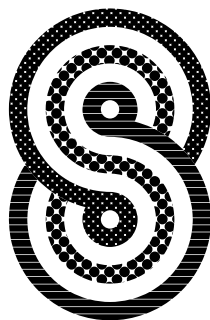

termok8 design

termok8 design esprime la sintesi tra know how tecnico-progettuale e bellezza architettonica: da questa sinergia nascono sistemi d'isolamento termico a cappotto che garantiscono le migliori performance energetiche ed estetiche.

Pelli decorative, superfici materiche, finiture modulari, complementi di superficie su misura, rivestimenti hi-tech con prestazioni certificate: tutto questo è **termok8** design by Ivas.

Le sezioni texture design e modular design, rappresentano proposte di finitura all'interno delle quali tecnologia e bellezza si fondono per ottenere prestazioni di livello assoluto.

termok8 design: quando la tecnologia incontra la bellezza.

termok8 design expresses the connection between technical know-how and architectural beauty: these thermal insulation systems are born to guarantee the best energy and aesthetic performances.

Decorative skins, textured surfaces, modular finishes, bespoke surface accessories, hi-tech coatings with certified performances: all this is **termok8** design by Ivas.

The texture design, modular design, deco design, high tech design sections of this catalog represent different finishing proposals in which technology and beauty come together to obtain outstanding level performances.

termok8 design: technology meeting beauty.

termok8 design rappresenta la sintesi entre los conocimientos técnicos de diseño y la belleza arquitectónica: de esta sinergia nacen sistemas de aislamiento térmico que garantizan las mejores prestaciones energéticas y estéticas.

Pieles decorativas, superficies texturizadas, acabados modulares, accesorios de superficie hechos a medida, revestimientos de alta tecnología con rendimientos certificados: todo esto es **termok8** design by Ivas.

Las secciones texture design, modular design, deco design, high tech design representan diferentes propuestas de acabados en los que la tecnología y la belleza se unen para obtener un rendimiento de nivel absoluto.

termok8 design: cuando la tecnología encuentra la belleza.

texture design

texture design è una collezione di superfici e rivestimenti materici ad alto valore estetico per i sistemi a cappotto: una scelta di valore per progetti contemporanei, unici e interamente personalizzati.

Tutte le soluzioni proposte sono applicabili anche su murature esterne prive d'isolamento a cappotto opportunamente trattate.

texture design is a collection of surfaces and coatings with high aesthetic value for architectural façade: a valuable choice for contemporary, unique and entirely customized projects.

The proposed solutions are also applicable on external walls without a thermal insulation system but properly treated.

texture design es una colección de superficies y revestimientos con un alto valor estético para la arquitectura de fachada: una opción de alto valor para proyectos contemporáneos, únicos y totalmente personalizados.

Las soluciones propuestas también son aplicables en paredes externas sin sistema de aislamiento térmico pero debidamente tratadas.



corten



cemento dilavato

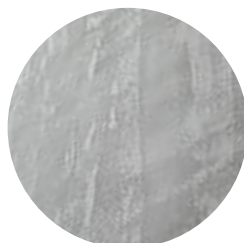

cemento spazzolato



urban



legno



travertino



striato



schiacciato



sabbaiato opaco

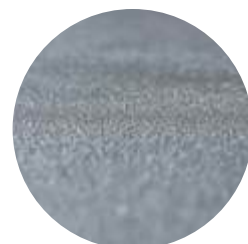

sabbaiato glitterato

modular design

modular design è una collezione di finiture modulari per i sistemi a cappotto: tecnologie durevoli che donano forma all'architettura contemporanea.

Materie, texture superficiali e dimensioni definiscono geometrie uniche e personalizzabili, nel modo tecnicamente più corretto e sicuro.

modular design is the collection of Ivas modular finishes for external systems: durable technologies that give shape to contemporary architecture.

The materials, surface textures and dimensions of modular design define unique and customizable geometries, responding to design needs in the most technically correct and safe way.

modular design es la colección de acabados modulares de Ivas para sistemas de aislamiento externos: tecnologías duraderas que dan forma a la arquitectura contemporánea.

Los materiales, las texturas y las dimensiones de modular design definen geometrías únicas y personalizables, respondiendo a las necesidades de diseño de la manera más técnicamente correcta y segura.



modular biostone



modular facciavista

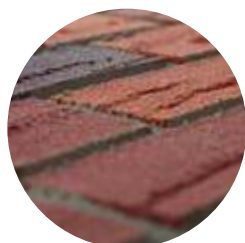

modular flex



modular d



modular big

texture design
sistemi Ivas con lastre in eps
opzioni :
termok8 BW Converto
termok8 Grafite Plus Converto
termok8 Fonostop Converto
termok8 Hp Converto
termok8 Classico Converto

sistemi Ivas con lastre minerali
opzioni :
termok8 Minerale L.R.*
termok8 Minerale L.V.*

texture design
Ivas systems with eps panel
options :
termok8 BW Converto
termok8 Grafite Plus Converto
termok8 Fonostop Converto
termok8 Hp Converto
termok8 Classico Converto

Ivas systems with mineral panel
options :
termok8 Minerale L.R.*
termok8 Minerale L.V.*

texture design
Sistemas Ivas con panel en eps
opciones :
termok8 BW Converto
termok8 Grafite Plus Converto
termok8 Fonostop Converto
termok8 Hp Converto
termok8 Classico Converto

Sistemas Ivas con panel mineral
opciones :
termok8 Minerale L.R.*
termok8 Minerale L.V.*

modular design
sistemi Ivas con lastre in eps
opzioni :
termok8 Modular Facciavista
termok8 Modular Biostone
termok8 Modular Flex
termok8 Modular D
termok8 Modular Big

sistemi Ivas con lastre minerali
termok8 Modular Flex L.R.*

modular design
Ivas systems with eps panel
options :
termok8 Modular Facciavista
termok8 Modular Biostone
termok8 Modular Flex
termok8 Modular D
termok8 Modular Big

Ivas systems with mineral panel
termok8 Modular Flex L.R.*

modular design
Sistemas Ivas con panel en eps
opciones :
termok8 Modular Facciavista
termok8 Modular Biostone
termok8 Modular Flex
termok8 Modular D
termok8 Modular Big

Sistemas Ivas con panel mineral
termok8 Modular Flex L.R.*



Le lastre isolanti di questi sistemi soddisfano pienamente i requisiti dei Criteri Ambientali Minimi per l'edilizia (CAM).

The insulating panels of these systems fully meet the requirements of the Minimum Environmental Criteria for construction (CAM).

Los paneles aislantes de estos sistemas cumplen totalmente con los requisitos de los Criterios Ambientales Mínimos para la construcción (CAM).



* Le lastre isolanti di questi sistemi offrono inoltre prestazioni certificate da specifiche Dichiarazioni Ambientali di Prodotto (EPD).

** The insulating panels of these systems also offer performance certified by specific Environmental Product Declarations (EPD).*

** Los paneles aislantes de estos sistemas también ofrecen un rendimiento certificado por las Declaraciones Ambientales de Producto (EPD) específicas.*

i sistemi

the systems

los sistemas

termok8 ha subito in questi anni le necessarie evoluzioni per rispondere alle accresciute esigenze tecniche ed estetiche del mercato ottemperando con semplicità ed efficacia alle normative vigenti. Attualmente comprende una vasta gamma di sistemi specializzati, accessori, complementi e finiture per offrire la soluzione più adeguata a tutte le esigenze progettuali: ingegneristiche, architettoniche o esecutive.

In recent years, termok8 has undergone the necessary developments to meet the increased technical and aesthetic requirements of the market by simply and effectively complying with the regulations in force. It currently includes a wide range of specialist systems, components, accessories and finishes to offer the most suitable solution for all design requirements, whether engineering, architectural or practical.

En los últimos años, termok8 ha evolucionado conforme a las exigencias técnicas y estéticas del mercado, cada vez mayores, cumpliendo en modo simple y eficaz con las normativas vigentes.

Comprende una amplia gama de sistemas especializados, accesorios, complementos y acabados para ofrecer la solución más adecuada a todas las exigencias de proyecto: de ingeniería, arquitectónicas o ejecutivas.

Legenda:



Legenda:



Legenda:

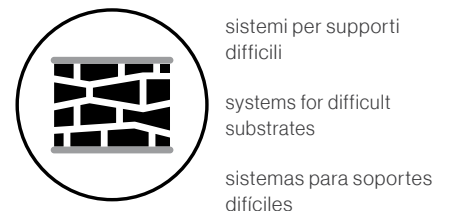



la scelta del sistema cappotto

In fase di progettazione è possibile scegliere il sistema funzionalmente più idoneo alle caratteristiche strutturali ed ambientali di progetto e supporto oppure costruirne uno, "cucito su misura", in funzione di particolari esigenze della committenza.



sistemi con lastre certificate epd
epd-approved slabs
sistemas con placas aprobadas epd

termok8® minerale eco
termok8® minerale l.v.
termok8® minerale l.r.
termok8® minerale su
termok8® modular flex l.r.
termok8® slim
termok8® wood



sistemi con lastre approvate cam
cam-approved slabs
sistemas con placas aprobadas cam

termok8® a.r. max 20 J
termok8® a.r. max 60 J
termok8® bw convertito
termok8® classico convertito
termok8® fenolico
termok8® fonostop convertito
termok8® grafite plus convertito
termok8® hp convertito
termok8® meccanico
termok8® minerale eco
termok8® minerale l.r.
termok8® minerale l.v.
termok8® minerale su
termok8® modular big
termok8® modular biostone
termok8® modular d
termok8® modular facciavista
termok8® modular flex
termok8® modular flex l.r.
termok8® slim
termok8® wood

choosing the external thermal insulation system

A system can be chosen, at the design stage, that is functionally most suitable for the structural and environmental characteristics of the design and the substrate or one can be tailor made, in accordance with the client's particular requirements.



bioedilizia
green building
ecoarchitettura

termok8® minerale eco
termok8® minerale l.v.
termok8® minerale l.r.
termok8® minerale su
termok8® modular flex l.r.
termok8® wood



elevata reazione al fuoco
high reaction to fire
elevada reacción al fuego

termok8® a.r. max 20 J
termok8® bw convertito
termok8® classico convertito
termok8® fenolico
termok8® fonostop convertito
termok8® grafite plus convertito
termok8® hp convertito
termok8® meccanico
termok8® minerale eco
termok8® minerale l.r.
termok8® minerale l.v.
termok8® modular big
termok8® modular biostone
termok8® modular d
termok8® modular facciavista
termok8® modular flex l.r.
termok8® slim

la elección del sistema de aislamiento térmico

Al elaborar el proyecto se puede elegir el sistema funcionalmente más adecuado para las características estructurales y ambientales del proyecto y del soporte, o bien construir uno, "a medida", en función de las exigencias específicas del cliente.

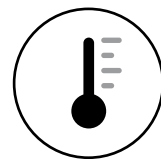

elevato isolamento
high level of insulation
elevado aislamiento

termok8® bw convertito
termok8® fenolico
termok8® fonostop convertito
termok8® grafite plus convertito
termok8® hp convertito
termok8® slim

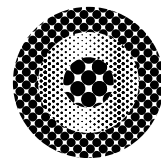

idoneo per le texture design
suitable for texture design
idóneo para los acabados texture design

termok8® bw convertito
termok8® fonostop convertito
termok8® grafite plus convertito
termok8® hp convertito
termok8® minerale l.v.
termok8® minerale l.r.

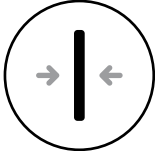

spessori ridotti r
 educed thickness
 espesores reducidos

termok8® fenolico
termok8® slim



lastre minerali
 mineral slabs
 placas minerales

termok8® minerale eco
termok8® minerale l.v.
termok8® minerale l.r.
termok8® modular flex l.r.

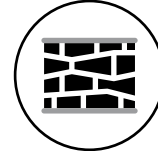

sistemi per supporti difficili
 systems for difficult substrates
 sistemas para soportes difíciles

termok8® meccanico



resistenza agli urti
 impact resistance
 resistencia al impacto

termok8® a.r. max 20 J
termok8® a.r. max 60 J
termok8® fonostop convertito
termok8® modular big
termok8® modular biostone
termok8® modular d
termok8® modular facciavista



semplicità di posa
 ease of installation
 fácil de colocar

termok8® bw convertito
termok8® classico convertito
termok8® fonostop convertito
termok8® grafite plus convertito
termok8® hp convertito

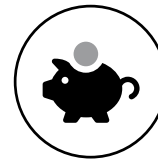

economicità
 cost-effectiveness
 económico

termok8® classico convertito



finitura modular design modular
 design finishes
 acabado modular design

termok8® modular big
termok8® modular biostone
termok8® modular d
termok8® modular facciavista
termok8® modular flex
termok8® modular flex l.r.



isolamento termoacustico thermal
 and acoustic insulation
 aislamiento termoacústico

termok8® fonostop convertito
termok8® minerale l.r.
termok8® minerale l.v.
termok8® modular flex
termok8® wood

complesso residenziale abitare in maggiolina, **termok8**® design modular big e **termok8**® bw converto, milano, it





prestazioni termiche e acustiche

thermal and acoustic performance

prestaciones térmicas y acústicas

termok8® meccanico



isolante / insulation / aislantes: eps meccanico r; eps g meccanico r

conduttività termica/thermal conductivity/conductividad térmica eps meccanico r: **0.035 W/(m·K)**
conduttività termica/thermal conductivity/conductividad térmica eps g meccanico r: **0.031 W/(m·K)**
reazione al fuoco del sistema/system reaction to fire/reacción del sistema al fuego: **Euroclass B, s1,d0**
resistenza al passaggio del vapore/resistance to vapour diffusion/resistencia al paso del vapor: **$\mu = 30-70$**

Soluzione ideale per installare il sistema a cappotto su superfici esterne dove l'incollaggio chimico non garantirebbe la tenuta del sistema; ideale per ripristinare pareti esterne particolarmente ammalorate, senza intervenire con opere di preparazione laboriose ed onerose.

Le lastre isolanti di questo sistema soddisfano i requisiti CAM (Criteri Ambientali Minimi).

The ideal option for installing the external thermal insulation system on external surfaces where chemical bonding would not guarantee the impermeability of the system; ideal for renovating exterior walls in particularly deteriorated condition, without the need for laborious and costly preparation work.

This system's insulation slabs are in compliance with the requirements of the Minimum Environmental Criteria (CAM) for building.



Solución ideal para instalar el sistema de aislamiento térmico en superficies externas donde el encolado químico no garantizaría la estanqueidad del sistema; ideal para recuperar paredes externas particularmente afectadas, sin necesidad de obras de preparación laboriosas y costosas.

Las placas aislantes de este sistema cumplen con los requisitos CAM (criterios ambientales mínimos).

termok8® classico convertito



isolante / insulation / aislantes: convertito 35-100

conduttività termica/thermal conductivity/conductividad térmica: **0.035 W/(m·K)**
reazione al fuoco del sistema/system reaction to fire/reacción del sistema al fuego: **Euroclass B, s1,d0**
resistenza al passaggio del vapore/resistance to vapour diffusion/resistencia al paso del vapor: **$\mu = 30-70$**

Soluzione ideale per ottemperare con semplicità ed efficacia alle disposizioni in materia di efficienza energetica assicurando tutti i vantaggi di un rivestimento a cappotto di qualità sia in sede di costruzione che manutenzione.

Le lastre isolanti di questo sistema soddisfano i requisiti CAM (Criteri Ambientali Minimi).

**Sistema dotato di certificazione
ETA-10/0231 e BBA**

The ideal option for simply and effectively complying with energy efficiency requirements, providing all the benefits of a high-quality external thermal insulation system both in construction and in maintenance.

This system's insulation slab is in compliance with the requirements of the Minimum Environmental Criteria (CAM) for building.

ETA-10/0231 and BBA certified system



Solución ideal para cumplir en modo simple y eficaz con las disposiciones vigentes en materia de eficiencia energética asegurando todas las ventajas de un revestimiento por capas de calidad, tanto a nivel de construcción como de mantenimiento.

Las placas aislantes de este sistema cumplen con los requisitos CAM (criterios ambientales mínimos).

**Sistema dotato di certificazione
ETA-10/0231 y BBA**

termok8® grafite plus convertito



isolante / insulation / aislantes: convertito 30-g; convertito 31-g plus

conduttività termica/thermal conductivity/conductividad térmica convertito 30-g: **0.030 W/(m·K)**
conduttività termica/thermal conductivity/conductividad térmica convertito 31-g plus: **0.031 W/(m·K)**
reazione al fuoco del sistema/system reaction to fire/reacción del sistema al fuego: **Euroclass B, s1,d0**
resistenza al passaggio del vapore/resistance to vapour diffusion/resistencia al paso del vapor: **$\mu = 30-70$**

Soluzione ideale per garantire prestazioni termiche particolarmente elevate, anche a bassi spessori, grazie alle particelle di grafite contenute all'interno della speciale lastra isolante detensionata. Garantisce stabilità dimensionale, perfetta planarità e incollaggio sicuro, anche durante il massimo irraggiamento solare. L'assenza di tagli superficiali garantisce massima omogeneità nella rasatura del cappotto, eliminando il rischio di cavillature causate dall'infiltrazione di rasante all'interno dei tagli stessi.

Le lastre isolanti di questo sistema soddisfano i requisiti CAM (Criteri Ambientali Minimi).

Particolarmente indicato alla successiva finitura decorativa Texture Design.

**Sistema dotato di certificazione
ETA-10/0231 e BBA**

The ideal option for guaranteeing very high thermal performance, even in thin coats, thanks to the graphite particles contained in the special, unstressed insulation slab. It ensures dimensional stability, perfectly flat surfaces, and secure gluing, even during maximum sunlight. The absence of any surface cuts ensures a truly uniform product when skimming the external thermal insulation system, eliminating the risk of crackling caused by the infiltration of the skim coat into the cuts themselves.

This system's insulation slab is in compliance with the requirements of the Minimum Environmental Criteria (CAM) for building.

Particularly suitable for the subsequent Texture Design decorative finish.

ETA-10/0231 and BBA certified system



Solución ideal para garantizar prestaciones térmicas particularmente elevadas, también con espesores bajos, gracias a las partículas de grafito en la placa aislante especial des-tensionada. Garantiza estabilidad dimensional, perfecta planicidad y un encolado seguro, incluso durante las horas de máxima irradiación solar. La ausencia de cortes superficiales garantiza la máxima homogeneidad en el enrasado del revestimiento por capas, eliminando el riesgo de cuarteados debidos a la infiltración de mortero de enrasado dentro de los cortes.

Las placas aislantes de este sistema cumplen con los requisitos CAM (criterios ambientales mínimos).

Especialmente indicado para el posterior acabado decorativo Texture Design.

**Sistema dotato di certificazione
ETA-10/0231 e BBA**

termok8® hp convertito



isolante / insulation / aislantes: convertito hp

conduttività termica/thermal conductivity/conductividad térmica: **0.030 W/(m·K)**
reazione al fuoco del sistema/system reaction to fire/reacción del sistema al fuego: **Euroclass B, s1,d0**
resistenza al passaggio del vapore/resistance to vapour diffusion/resistencia al paso del vapor: **$\mu = 20-40$**

Soluzione ideale per ottenere performance termiche elevate abbinando spessori ridotti e facilità di posa. Caratterizzato da uno speciale pannello in grafite con superficie bianca, prodotto in unico processo produttivo per sintolaminazione, assicura totale omogeneità termica abbinando le prestazioni delle grafite con la semplicità e velocità di posa del tradizionale polistirene bianco. Rispetto a soluzioni tradizionali in EPS, a parità di spessore applicato e tipologia di supporto, aumenta del 19% le prestazioni isolanti grazie all'innovativo pannello HP (High Performance) combinato al collante-rasante di ultima generazione (Klebocem Termico) con valore di conduttività termica $\lambda = 0,23$ W/(m·K) che assicura prestazioni isolanti quattro volte superiori ad un rasante-collante standard $\lambda = 0,85$ W/(m·K)

Le lastre isolanti di questo sistema soddisfano i requisiti CAM (Criteri Ambientali Minimi).

Particolarmente indicato alla successiva finitura decorativa Texture Design.

**Sistema dotato di certificazione
ETA-10/0231**

The ideal option for high thermal performance that combines reduced thickness and easy installation. It features a special graphite panel with white surface – obtained through a unique lamination synthesis process – that ensures truly uniform thermal properties by combining the performance of graphite with the simplicity and easy installation of conventional white polystyrene. Compared to conventional EPS solutions, with the same applied thickness and type of substrate, insulating performance increases by 19% due to the innovative High Performance (HP) panel combined with the state-of-the-art adhesive-skim coat (Klebocem Termico) with thermal conductivity value $\lambda = 0.23$ W/(m·K) which ensures insulating performance four times higher than a standard adhesive-skim coat

$\lambda = 0.85$ W/(m·K). This system's insulation slab is in compliance with the requirements of the Minimum Environmental Criteria (CAM) for building.

Particularly suitable for the subsequent Texture Design decorative finish.

ETA-10/0231 certified system



Solución ideal para obtener las más altas prestaciones térmicas combinando espesores reducidos simplicidad y rapidez de colocación. Caracterizado por un panel especial de grafito con superficie blanca, producido en un único proceso de fabricación por sinterización-laminación asegura total homogeneidad térmica combinando las prestaciones del grafito con la simplicidad y rapidez de colocación del tradicional poliestireno blanco. En comparación con las soluciones tradicionales en EPS, con el mismo espesor aplicado y la misma tipología de soporte, aumenta de 19% las prestaciones aislantes gracias al innovador panel HP (High Performance - Altas Prestaciones) combinado al adhesivo/mortero de enrasado (Klebocem Termico) con un valor de conductividad térmica $\lambda = 0,23$ W/(m·K) que asegura prestaciones aislantes cuatro veces superiores a un mortero de enrasado/cola estándar $\lambda = 0,85$ W/(m·K). Las placas aislantes de este sistema cumplen con los requisitos CAM (criterios ambientales mínimos).

Especialmente indicado para el posterior acabado decorativo Texture Design.

**Sistema dotato di certificazione
ETA-10/0231**

termok8® bw converto



isolante / insulation / aislantes: converto 31 BW

conduttività termica/thermal conductivity/conductividad térmica Converto 31 BW: **0.031 W/(m·K)**
reazione al fuoco del sistema/system reaction to fire/reacción del sistema al fuego: **Euroclass B, s1,d0**
resistenza al passaggio del vapore/resistance to vapour diffusion/resistencia al paso del vapor: **$\mu = 20-40$**

Soluzione ideale per garantire prestazioni termiche particolarmente elevate, anche a bassi spessori, grazie alle particelle di grafite contenute all'interno della speciale lastra isolante detensionata. Garantisce stabilità dimensionale, perfetta planarità e incollaggio sicuro, anche durante il massimo irraggiamento solare. L'assenza di tagli superficiali garantisce massima omogeneità nella rasatura del cappotto, eliminando il rischio di cavillature causate dall'infiltrazione di rasante all'interno dei tagli stessi.

Le lastre isolanti di questo sistema soddisfano i requisiti CAM (Criteri Ambientali Minimi).

Particolarmente indicato alla successiva finitura decorativa Texture Design.

**Sistema dotato di certificazione
ETA-10/0231 e BBA**

The ideal option for guaranteeing very high thermal performance, even in thin coats, thanks to the graphite particles contained in the special, unstressed insulation slab. It ensures dimensional stability, perfectly flat surfaces, and secure gluing, even during maximum sunlight. The absence of any surface cuts ensures a truly uniform product when skimming the external thermal insulation system, eliminating the risk of cracking caused by the infiltration of the skim coat into the cuts themselves.

This system's insulation slab is in compliance with the requirements of the Minimum Environmental Criteria (CAM) for building.

Particularly suitable for the subsequent Texture Design decorative finish.

ETA-10/0231 and BBA certified system



Solución ideal para garantizar prestaciones térmicas particularmente elevadas, también con espesores bajos, gracias a las partículas de grafito en la placa aislante especial destensionada. Garantiza estabilidad dimensional, perfecta planicidad y un encolado seguro, incluso durante las horas de máxima irradiación solar. La ausencia de cortes superficiales garantiza la máxima homogeneidad en el enrasado del revestimiento por capas, eliminando el riesgo de cuarteados debidos a la infiltración de mortero de enrasado dentro de los cortes. Las placas aislantes de este sistema cumplen con los requisitos CAM (criterios ambientales mínimos).

Especialmente indicado para el posterior acabado decorativo Texture Design.

**Sistema dotato di certificazione
ETA-10/0231 y BBA**

termok8® fonostop converto



isolante / insulation / aislantes: converto fonostop

conduttività termica/thermal conductivity/conductividad térmica: **0.031 W/(m·K)**
reazione al fuoco del sistema/system reaction to fire/reacción del sistema al fuego: **Euroclass B, s1,d0**
resistenza al passaggio del vapore/resistance to vapour diffusion/resistencia al paso del vapor: **$\mu = 20-40$**

Soluzione ideale per ottemperare con semplicità ed efficacia alle disposizioni in materia di efficienza energetica ed inquinamento acustico. Il sistema prevede un pannello in EPS con grafite a bassa rigidità dinamica, caratterizzato da speciale zigrinatura, studiato per un ottimale rapporto tra potere termoisolante e fonoisolante abbinato alla massima semplicità di posa e a un'ottima reazione al fuoco. Questa soluzione è anche caratterizzata da elevata resistenza agli urti (20 Joule).

Le lastre isolanti di questo sistema soddisfano i requisiti CAM (Criteri Ambientali Minimi).

Particolarmente indicato alla successiva finitura decorativa Texture Design.

**Sistema dotato di certificazione
di Fonoisolamento ed ETA-10/0231**

The ideal option for simply and effectively complying with the regulations on energy efficiency and noise pollution. The system includes an EPS panel with low dynamic stiffness graphite, featuring a special grooved pattern, designed to give the optimal balance between thermal and acoustic insulation properties combined with maximum ease of installation and excellent reaction to fire. This option is also characterised by high resistance to impacts (20 joules).

This system's insulation slab is in compliance with the requirements of the Minimum Environmental Criteria (CAM) for building.

Particularly suitable for the subsequent Texture Design decorative finish.

**System certified for acoustic insulation
and ETA-10/0231 certified**



Solución ideal para cumplir en modo simple y eficaz con las disposiciones vigentes en materia de eficiencia energética y contaminación acústica. El sistema utiliza un panel en EPS con grafite de baja rigidez dinámica, caracterizado por un moleteado especial, estudiado para una relación ideal entre poder aislante térmico y acústico, combinado con la máxima simplicidad de aplicación y una excelente reacción al fuego. Esta solución se caracteriza también por una elevadísima resistencia al impacto (20 Joule).

Las placas aislantes de este sistema cumplen con los requisitos CAM (criterios ambientales mínimos).

Especialmente indicado para el acabado decorativo Texture Design.

**Sistema dotato di certificazione
de Aislamiento Acústico y ETA-10/0231**

termok8® a.r. max 20 J



isolante / insulation / aislantes: eps 35 max r; eps 31-g max r

conduttività termica/thermal conductivity/conductividad térmica EPS 31-G Max R: **0.031 W/(m·K)**
 conduttività termica/thermal conductivity/conductividad térmica EPS 35-100 Max R: **0.035 W/(m·K)**
 reazione al fuoco del sistema/system reaction to fire/reacción del sistema al fuego: **Euroclass B, s1,d0**
 resistenza al passaggio del vapore/resistance to vapour diffusion/resistencia al paso del vapor: **μ = 30-70**

Soluzione ideale per ottenere superfici esterne ad elevatissima resistenza agli urti e "shock meccanici" quale la grandine (20 Joule). Il connubio tra l'elasticità della lastra ed il rasante specificamente formulato conferisce una resistenza senza fessurazioni certificata oltre i valori richiesti dalla normativa. Può essere utilizzato in abbinamento ad altri sistemi termok8 per le zoccolature dei fabbricati, le porzioni esposte ad urti accidentali, quelle contro terra, nonché quelle che richiedano basso assorbimento d'acqua.

Le lastre isolanti di questo sistema soddisfano i requisiti CAM (Criteri Ambientali Minimi).

Sistema dotato di certificazione di resistenza agli urti ed ETA-10/0231

The ideal option for external surfaces with very high resistance to impacts and mechanical shocks, such as hail (20 Joules). The combination of the elasticity of the slab and the specifically formulated skim coat provides certified crack-free resistance that exceeds the values required by regulations. It can be used together with other termok8 systems for building plinths, areas exposed to accidental impacts, areas in contact with the ground, as well as areas that require low water absorption.

This system's insulation slabs are in compliance with the requirements of the Minimum Environmental Criteria (CAM) for building.

System certified for impact resistance and ETA-10/0231 certified



Solución ideal para obtener superficies externas de muy alta resistencia a los impactos e "impactos mecánicos" como el granizo (20 Julios). La combinación entre la elasticidad de la placa y el mortero de enrasado específicamente formulado proporciona una resistencia sin fisuras certificada que supera los valores exigidos por la normativa. Puede utilizarse combinado con otros sistemas termok8 para los rodapiés de los edificios, las partes expuestas a impactos accidentales, las partes en contacto con el suelo y aquellas que requieran una baja absorción de agua. Las placas aislantes de este sistema cumplen con los requisitos CAM (criterios ambientales mínimos).

Sistema dotato di certificazione de resistenza a los impactos y ETA-10/0231

termok8® a.r. max 60 J



isolante / insulation / aislantes: eps 35-100 max r; eps 31-g max r

conduttività termica/thermal conductivity/conductividad térmica EPS 31-G Max R: **0.031 W/(m·K)**
 conduttività termica/thermal conductivity/conductividad térmica EPS 35-100 Max R: **0.035 W/(m·K)**
 resistenza al passaggio del vapore/resistance to vapour diffusion/resistencia al paso del vapor: **μ = 30-70**

Soluzione ideale per ottenere superfici esterne ad elevatissima resistenza agli urti e "shock meccanici" quali grandine (60 Joule). Il connubio tra l'elasticità della lastra ed il rasante specificamente formulato conferisce una resistenza senza fessurazioni certificata oltre i valori richiesti dalla normativa. Può essere utilizzato in abbinamento ad altri sistemi termok8 per le zoccolature dei fabbricati, le porzioni esposte ad urti accidentali, quelle contro terra, nonché quelle che richiedano basso assorbimento d'acqua. certificato di resistenza agli urti.

Le lastre isolanti di questo sistema soddisfano i requisiti CAM (Criteri Ambientali Minimi).

Sistema dotato di certificazione di resistenza agli urti

The ideal option for external surfaces with very high resistance to impacts and mechanical shocks, such as hail (60 Joules). The combination of the elasticity of the slab and the specifically formulated skim coat provides certified crack-free resistance that exceeds the values required by regulations. It can be used together with other termok8 systems for building plinths, areas exposed to accidental impacts, areas in contact with the ground, as well as areas that require low water absorption. System certified for impact resistance.

This system's insulation slabs are in compliance with the requirements of the Minimum Environmental Criteria (CAM) for building.

System certified for impact resistance



Solución ideal para obtener superficies externas de muy alta resistencia a los impactos e "impactos mecánicos" como el granizo (60 Julios). La combinación entre la elasticidad de la placa y el mortero de enrasado específicamente formulado proporciona una resistencia sin fisuras certificada que supera los valores exigidos por la normativa. Puede utilizarse combinado con otros sistemas termok8 para los rodapiés de los edificios, las partes expuestas a impactos accidentales, las partes en contacto con el suelo y aquellas que requieran una baja absorción de agua. Certificado de resistencia a los impactos.

Las placas aislantes de este sistema cumplen con los requisitos CAM (criterios ambientales mínimos).

Sistema dotato di certificación de resistencia a los golpes

best performance $\lambda < 0.030$

best performance $\lambda < 0.030$

best performance $\lambda < 0.030$

termok8® fenolico



isolante / insulation / aislantes: ph 20; ph 20 king

conduttività termica/thermal conductivity/conductividad térmica PH 20 2 a 7 cm: **0.021 W/(m·K) >8cm 0.019 W/(m·K)**
conduttività termica/thermal conductivity/conductividad térmica PH 20 King: 2 a 4 cm: **0.021 W/(m·K) >5 cm 0,020 W/(m·K)**
reazione al fuoco del sistema/system reaction to fire/reacción del sistema al fuego: **Euroclass B, s1,d0**
resistenza al passaggio del vapore/resistance to vapour diffusion/resistencia al paso del vapor PH 20 $\mu = 40$
resistenza al passaggio del vapore/resistance to vapour diffusion/resistencia al paso del vapor PH 20 King $\mu = 35$

Soluzione ideale per abbinare elevata efficienza termica e basso spessore d'isolante. Particolarmente indicato in caso di ristrutturazioni date le alte prestazioni di resistenza termica del pannello fenolico.

Lastra isolante dotata di EPD (certificazione ambientale di prodotto).

Le lastre isolanti di questo sistema soddisfano i requisiti CAM (Criteri Ambientali Minimi).

Sistema dotato di certificazione BBA

The ideal option for combining high thermal efficiency and low insulation thickness. Particularly suitable in case of renovations due to the high thermal resistance performance of the phenolic panel.

Insulation slab with EPD (Environmental Product Declaration).

This system's insulation slab is in compliance with the requirements of the Minimum Environmental Criteria (CAM) for building.

BBA certified system



Solución ideal para combinar alta eficiencia térmica y bajo espesor de aislante.

Especialmente indicado para actuaciones de reacondicionamiento, dadas las altas prestaciones de resistencia térmica del panel fenólico.

Placa aislante dotada de EPD (certificación ambiental de producto).

Las placas aislantes de este sistema cumplen con los requisitos CAM (criterios ambientales mínimos).

Sistema dotado de certificación BBA

termok8® slim



isolante / insulation / aislantes: Stiferite Class sk - PIR (poliuretano)

conduttività termica/thermal conductivity/conductividad térmica Stiferite Class sk < 8 cm: **0.028 W/(m·K)** 8 cm a 12 cm: **0.026 W/(m·K)** > 12 cm: **0.025 W/(m·K)**
conduttività termica/thermal conductivity/conductividad térmica PIR (poliuretano) < 8 cm: **0.027 W/(m·K)** 80 a 100 cm: **0.025 W/(m·K)** 120 a 260 cm: **0.024 W/(m·K)**
reazione al fuoco del sistema/system reaction to fire/reacción del sistema al fuego: **Euroclass B, s1,d0**
resistenza al passaggio del vapore/resistance to vapour diffusion/resistencia al paso del vapor Stiferite Class sk: $\mu = 56$
resistenza al passaggio del vapore/resistance to vapour diffusion/resistencia al paso del vapor PIR (poliuretano): $\mu = 40-120$

Soluzione ideale per abbinare elevata efficienza termica e basso spessore d'isolante. Particolarmente indicato nella riqualificazione energetica di fabbricati esistenti grazie a spessori ridotti a parità di potere isolante.

Lastra isolante dotata di EPD (certificazione ambientale di prodotto).

Le lastre isolanti di questo sistema soddisfano i requisiti CAM (Criteri Ambientali Minimi).

Sistema dotato di certificazione ETA -24/0905 e BBA

The ideal option for combining high thermal efficiency and low insulation thickness. Especially suitable for upgrading the energy efficiency of existing buildings, due to its reduced thickness for equivalent insulation performance.

Insulation slab with EPD (Environmental Product Declaration).

This system's insulation slab is in compliance with the requirements of the Minimum Environmental Criteria (CAM) for building.

ETA -24/0905 and BBA certified system

Solución ideal para combinar alta eficiencia térmica y bajo espesor de aislante.

Especialmente indicado en la recalificación energética de edificios existentes, dado que ofrece espesores menores para el mismo poder aislante.

Placa aislante dotada de EPD (certificación ambiental de producto).

Las placas aislantes de este sistema cumplen con los requisitos CAM (criterios ambientales mínimos).

Sistema dotado de certificación ETA -24/0905 y BBA



termok8® wood



isolante / insulation / aislantes: fibra di legno

conduttività termica/thermal conductivity/conductividad térmica: **0.040 W/(m·K)**
 resistenza al passaggio del vapore/resistance to vapour diffusion/resistencia al paso del vapor: **μ = 3**

Soluzione ideale per rispondere alle esigenze della progettazione bioedilizia garantendo elevate prestazioni termoacustiche e di permeabilità al vapore. Particolarmente indicato per l'isolamento delle superfici in legno. Utilizza quale isolante fibra di legno monostrato.

Lastra isolante dotata di EPD (certificazione ambientale di prodotto).

Le lastre isolanti di questo sistema soddisfano i requisiti CAM (Criteri Ambientali Minimi).

Sistema dotato di certificazione Nature Plus e Pefc

Ideal solution to meet the demands of sustainable building design, guaranteeing superb thermoacoustic performance and vapour permeability. Particularly suited to insulating wooden surfaces. It uses single-ply wood fibre as insulating material.

Insulation slab with EPD (Environmental Product Declaration).

This system's insulation slab is in compliance with the requirements of the Minimum Environmental Criteria (CAM) for building.

Nature Plus and PEFC certified system



Solución ideal para responder a las exigencias de los proyectos de ecoarquitectura garantizando altas prestaciones termoacústicas y de permeabilidad al vapor. Particolarmente indicado para aislamiento de superficies de madera.

Utiliza como aislante monocapa de fibra de madera.

Placa aislante dotada de EPD (certificación ambiental de producto).

Las placas aislantes de este sistema cumplen con los requisitos CAM (criterios ambientales mínimos).

Sistema dotado de certificación Nature Plus y PEFC

termok8® sughero



isolante / insulation / aislantes: sughero ambrato

conduttività termica/thermal conductivity/conductividad térmica: **0.040 W/(m·K)**
 resistenza al passaggio del vapore/resistance to vapour diffusion/resistencia al paso del vapor: **μ = 20**

Soluzione ideale in ambito di progettazione bio-edilizia; oltre alla composizione minerale, utilizza quale isolante sughero ambrato naturale.

Lastra isolante dotata di EPD (certificazione ambientale di prodotto).

Le lastre isolanti di questo sistema soddisfano i requisiti CAM (Criteri Ambientali Minimi).

Sistema dotato di certificazione di eco-compatibilità

The ideal solution in the field of sustainable building design; in addition to its mineral composition, it uses natural amber-coloured cork as insulation.

Insulation slab with EPD (Environmental Product Declaration).

This system's insulation slab is in compliance with the requirements of the Minimum Environmental Criteria (CAM) for building.

System certified for eco-compatibility



Solución ideal para proyectos de eco-arquitectura; además de la composición mineral, utiliza como aislante corcho ámbar natural.

Placa aislante dotada de EPD (certificación ambiental de producto).

Las placas aislantes de este sistema cumplen con los requisitos CAM (criterios ambientales mínimos).

Sistema dotado de certificación de eco-compatibilidad

termok8® minerale eco



isolante / insulation / aislantes: multipor

conduttività termica/thermal conductivity/conductividad térmica: **0.045 W/(m·K)**

resistenza al passaggio del vapore/resistance to vapour diffusion/resistencia al paso del vapor: **$\mu = 3$**

Soluzione ideale per l'isolamento termico delle facciate esterne di edifici esistenti e nuovi a basso consumo energetico, coniuga una alta elevata traspirabilità di tutti i suoi componenti ad ottime prestazioni termiche. Caratterizzato da pannelli isolanti minerali a base di calcio silicato, che garantiscono rigidità e stabilità, resistenza al fuoco ed elevata traspirabilità, scongiurando il rischio della formazione di muffe e assicurando la durabilità nel tempo del prodotto.

Lastra isolante dotata di EPD (certificazione ambientale di prodotto).

Le lastre isolanti di questo sistema soddisfano i requisiti CAM (Criteri Ambientali Minimi).

The ideal solution for the thermal insulation of the exterior façades of existing and new buildings with low energy consumption, combining the high breathability of all its components with excellent thermal performance. Characterised by mineral insulation panels with a base of calcium silicate, which ensure rigidity and stability, fire resistance, and high breathability, preventing the risk of mould formation and ensuring product durability.

Insulation slab with EPD (Environmental Product Declaration).

This system's insulation slab is in compliance with the requirements of the Minimum Environmental Criteria (CAM) for building.



Solución ideal para el aislamiento térmico de las fachadas externas de edificios ya existentes y nuevos de bajo consumo energético, conjuga la elevada traspirabilidad de todos sus componentes con excelentes prestaciones térmicas. Caracterizado por paneles aislantes minerales a base de silicato de calcio, que garantizan rigidez y estabilidad, resistencia al fuego y alta traspirabilidad, que hacen desaparecer el riesgo de formación de mohos y aseguran la durabilidad del producto a largo plazo.

Placa aislante dotada de EPD (certificación ambiental de producto).

Las placas aislantes de este sistema cumplen con los requisitos CAM (criterios ambientales mínimos).

termok8® minerale l.v.



isolante / insulation / aislantes: lana di vetro k34

conduttività termica/thermal conductivity/conductividad térmica: **0.034 W/(m·K)**

reazione al fuoco del sistema/system reaction to fire/reacción del sistema al fuego: **Euroclass A2, s1, d0**

resistenza al passaggio del vapore/resistance to vapour diffusion/resistencia al paso del vapor: **$\mu = 1$**

Soluzione ideale per rivestire l'edificio garantendo elevate prestazioni termiche e acustiche. Il sistema, di composizione prevalentemente minerale, possiede ottima reazione al fuoco, resistenza agli urti e traspirabilità al vapore acqueo.

Lastra isolante dotata di EPD (certificazione ambientale di prodotto).

Le lastre isolanti di questo sistema soddisfano i requisiti CAM (Criteri Ambientali Minimi).

Particolarmente indicato alla successiva finitura decorativa Texture Design.

**Sistema dotato di certificazione
ETA-10/0231**

The ideal option for cladding a building, providing high thermal and acoustic performance. The system is mainly of mineral composition and has excellent reaction to fire, impact resistance and water vapour permeability properties. Insulation slab with EPD (Environmental Product Declaration). This system's insulation slab is in compliance with the requirements of the Minimum Environmental Criteria (CAM) for building.

Particularly suitable for the subsequent Texture Design decorative finish.

ETA-10/0231 certified system



Solución ideal para revestir el edificio garantizando altas prestaciones térmicas y acústicas. El sistema, de composición predominantemente mineral, ofrece una excelente reacción al fuego, resistencia a los golpes y traspirabilidad ante el vapor de agua.

Placa aislante dotada de EPD (certificación ambiental de producto).

Las placas aislantes de este sistema cumplen con los requisitos CAM (criterios ambientales mínimos).

Particolarmente indicado para el acabado decorativo Texture Design.

**Sistema dotato de certificación
ETA-10/0231**

termok8® minerale I.r.



isolante / insulation / aislantes: lana di roccia monodensità; lana di roccia doppia densità

conduttività termica monodensità/thermal conductivity of single-density rock wool/conductividad térmica monodensidad: **0.034-0.035 W/(m·K)**
conduttività termica doppia densità/thermal conductivity of double-density rock wool/conductividad térmica doble densidad: **0.034 W/(m·K)**
reazione al fuoco del sistema/system reaction to fire/reacción del sistema al fuego: **Euroclass A2, s1, d0**
resistenza al passaggio del vapore/resistance to vapour diffusion/resistencia al paso del vapor: **$\mu = 1$**

Soluzione ideale per rivestire ed isolare l'edificio ponendo particolare attenzione alle caratteristiche termoacustiche e di resistenza al fuoco del sistema; è caratterizzato da elevata traspirabilità e da una composizione prevalentemente minerale.

Lastra isolante dotata di EPD (certificazione ambientale di prodotto).

Le lastre isolanti di questo sistema soddisfano i requisiti CAM (Criteri Ambientali Minimi).

Particolarmente indicato alla successiva finitura decorativa Texture Design.

**Sistema dotato di certificazione
ETA-10/0231 e BBA**

The ideal option for cladding and insulating a building, with particular emphasis on the system's thermal, acoustic and fire resistant properties, featuring high breathability and a predominantly mineral composition.

Insulation slab with EPD (Environmental Product Declaration).

This system's insulation slab is in compliance with the requirements of the Minimum Environmental Criteria (CAM) for building.

Particularly suitable for the subsequent Texture Design decorative finish.

ETA-10/0231 and BBA certified system



Solución ideal para revestir y aislar el edificio prestando particular atención a las características termoacústicas y de resistencia al fuego del sistema; se caracteriza por ser altamente transpirante y por su composición predominantemente mineral.

Placa aislante dotada de EPD (certificación ambiental de producto).

Las placas aislantes de este sistema cumplen con los requisitos CAM (criterios ambientales mínimos).

Especialmente indicado para el acabado decorativo Texture Design.

**Sistema dotado de certificación
ETA-10/0231 y BBA**

termok8® modular flex



isolante / insulation / aislantes: converto 35-100; converto 31-g plus

conduttività termica/thermal conductivity/conductividad térmica Converto 35-100: **0.035 W/(m·K)**
 conduttività termica/thermal conductivity/conductividad térmica Converto 31-G Plus: **0.031 W/(m·K)**
 reazione al fuoco del sistema/system reaction to fire/reacción del sistema al fuego: **Euroclass B, s2, d0**
 resistenza al passaggio del vapore/resistance to vapour diffusion/resistencia al paso del vapor: **$\mu = 30-70$**

La soluzione tecnica per facciate modulari di semplice e veloce installazione: leggero, traspirante, flessibile e multicolore.

Le lastre isolanti di questo sistema soddisfano i requisiti CAM (Criteri Ambientali Minimi).

Sistema dotato di certificazione BBA

The technical solution for modular façades that is quick and easy to install: lightweight, breathable, flexible, and multi-coloured.

This system's insulation slabs are in compliance with the requirements of the Minimum Environmental Criteria (CAM) for building.

BBA certified system



La solución técnica para fachadas modulares de instalación simple y rápida: ligero, transpirante, flexible y multicolor.

Las placas aislantes de este sistema cumplen con los requisitos CAM (criterios ambientales mínimos).

Sistema dotato di certificación BBA

termok8® modular flex l.r.



isolante / insulation / aislantes: lana di roccia monodensità; lana di roccia doppia densità

conduttività termica monodensità/thermal conductivity of single-density rock wool/conductividad térmica monodensidad: **0.034 - 0.036 W/(m·K)**
 conduttività termica doppia densità/thermal conductivity of double-density rock wool/conductividad térmica doble densidad: **0.034 W/(m·K)**
 reazione al fuoco del sistema/reacción del sistema al fuego/system reaction to fire: **Euroclass A2, s1, d0**
 resistenza al passaggio del vapore/resistance to vapour diffusion/resistencia al paso del vapor: **$\mu = 1$**

La soluzione tecnica per facciate modulari di semplice e veloce installazione: leggero, traspirante, flessibile e multicolore.

Lastra isolante dotata di EPD (certificazione ambientale di prodotto).

Le lastre isolanti di questo sistema soddisfano i requisiti CAM (Criteri Ambientali Minimi).

Sistema dotato di certificazione BBA

The technical solution for modular façades that is quick and easy to install: lightweight, breathable, flexible, and multi-coloured.

Insulation slab with EPD (Environmental Product Declaration).

This system's insulation slabs are in compliance with the requirements of the Minimum Environmental Criteria (CAM) for building.

BBA certified system



La solución técnica para fachadas modulares de instalación simple y rápida: ligero, transpirante, flexible y multicolor.

Placa aislante dotada de EPD (certificación ambiental de producto).

Las placas aislantes de este sistema cumplen con los requisitos CAM (criterios ambientales mínimos).

Sistema dotato di certificación BBA

termok8® modular facciavista

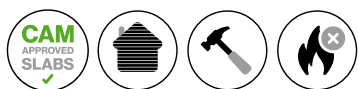

isolante / insulation / aislantes: eps 31 g-100 fix r; eps 35-100 fix r; converto 31 bw fix

conduttività termica/thermal conductivity/conductividad térmica EPS 31 G-100 Fix R: **0.031 W/(m·K)**
conduttività termica/thermal conductivity/conductividad térmica EPS 35-100 Fix R: **0.035 W/(m·K)**
conduttività termica/thermal conductivity/conductividad térmica converto 31 BW Fix: **0.031 W/(m·K)**
reazione al fuoco del sistema/system reaction to fire/reacción del sistema al fuego: **Euroclass B, s1, d0**
resistenza al passaggio del vapore/resistance to vapour diffusion/resistencia al paso del vapor: **$\mu = 30-70$**

Soluzione ideale per combinare particolari esigenze estetiche della committenza con quelle tecniche della progettazione; il rivestimento in mattone facciavista, con le sue molteplici finiture, assicura al sistema forte impatto emotivo ed elevata personalizzazione.

Le lastre isolanti di questo sistema soddisfano i requisiti CAM (Criteri Ambientali Minimi).

**Sistema dotato di certificazione
ETA-23/0221 e BBA**

The ideal option for combining the client's specific aesthetic requirements with the technical ones of the design; fair-faced brick cladding, with its numerous finishes, gives the system strong emotional impact and a high degree of personal choice.

This system's insulation slabs are in compliance with the requirements of the Minimum Environmental Criteria (CAM) for building.

ETA-23/0221 and BBA certified system

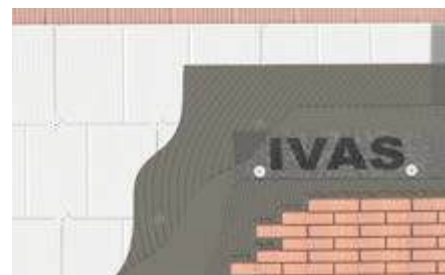

Solución ideal para combinar particulares exigencias estéticas de los clientes con las exigencias técnicas del proyecto; el revestimiento en ladrillo a la vista, con sus muchos acabados, asegura al sistema un fuerte impacto emotivo y elevada personalización.

Las placas aislantes de este sistema cumplen con los requisitos CAM (criterios ambientales mínimos).

**Sistema dotato di certificazione
ETA-23/0221 y BBA**

termok8® modular d



isolante / insulation / aislantes: eps 31 g-100 fix r; eps 35-100 fix r; converto 31 bw fix

conduttività termica/thermal conductivity/conductividad térmica EPS 31 G-100 Fix R: **0.031 W/(m·K)**
conduttività termica/thermal conductivity/conductividad térmica EPS 35-100 Fix R: **0.035 W/(m·K)**
conduttività termica/thermal conductivity/conductividad térmica converto 31 BW Fix: **0.031 W/(m·K)**
reazione al fuoco del sistema/system reaction to fire/reacción del sistema al fuego: **Euroclass B, s1, d0**
resistenza al passaggio del vapore/resistance to vapour diffusion/resistencia al paso del vapor: **$\mu = 30-70$**

Soluzione ideale per realizzare sul sistema termok8 particolari finiture esterne personalizzate con rivestimenti modulari: dalla finitura tipo listello rustico a quella in elementi ceramici in Gres o Clinker.

Le lastre isolanti di questo sistema soddisfano i requisiti CAM (Criteri Ambientali Minimi).

**Sistema dotato di certificazione
ETA-23/0221 e BBA**

The ideal option for achieving specific customised exterior finishes for the termok8 system using modular cladding materials: from rustic slip type finishes to those using ceramic elements made of stoneware or clinker.

This system's insulation slabs are in compliance with the requirements of the Minimum Environmental Criteria (CAM) for building.

ETA-23/0221 and BBA certified system



Solución ideal para realizar en el sistema termok8 particulares acabados externos personalizados con revestimientos modulares: del acabado tipo ladrillo rústico al acabado en elementos cerámicos de Gres o Clinker.

Las placas aislantes de este sistema cumplen con los requisitos CAM (criterios ambientales mínimos).

**Sistema dotato di certificazione
ETA-23/0221 y BBA**

termok8® modular big

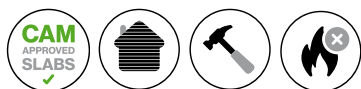

isolante / insulation / aislantes: eps 31 g-100 fix r; eps 35-100 fix r; converto 31 bw fix

conduttività termica/thermal conductivity/conductividad térmica EPS 31 G-100 Fix R: **0.031 W/(m·K)**
conduttività termica/thermal conductivity/conductividad térmica EPS 35-100 Fix R: **0.035 W/(m·K)**
conduttività termica/thermal conductivity/conductividad térmica converto 31 BW Fix: **0.031 W/(m·K)**
reazione al fuoco del sistema/system reaction to fire/reacción del sistema al fuego: **Euroclass B-s1, d0**
resistenza al passaggio del vapore/resistance to vapour diffusion/resistencia al paso del vapor: **$\mu = 30-70$**

Soluzione ideale per ottenere isolamenti a cappotto in ottemperanza alle disposizioni in materia di efficienza energetica caratterizzati da rivestimenti in gres porcellanato a strato sottile in grande formato dal forte e personale impatto architettonico.

Le lastre isolanti di questo sistema soddisfano i requisiti CAM (Criteri Ambientali Minimi).

**Sistema dotato di certificazione
ETA-23/0221**

Ideal solution for insulation cladding systems that meet energy efficiency regulations. Features thin layer, large format porcelain stoneware cladding with strong, personal architectural impact.

This system's insulation slabs are in compliance with the requirements of the Minimum Environmental Criteria (CAM) for building.

ETA-23/0221 and BBA certified system



Solución ideal para obtener aislamientos por capas, en cumplimiento de las disposiciones en materia de eficiencia energética, caracterizados por revestimientos en gres porcelánico de capa fina en formato grande de impacto arquitectónico fuerte y personal.

Las placas aislantes de este sistema cumplen con los requisitos CAM (criterios ambientales mínimos).

**Sistema dotato di certificazione
ETA-23/0221 y BBA**

termok8® modular biostone

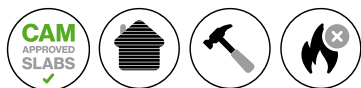

isolante / insulation / aislantes: eps 31 g-100 fix r; eps 35-100 fix r; converto 31 bw fix

conduttività termica/thermal conductivity/conductividad térmica EPS 31 G-100 Fix R: **0.031 W/(m·K)**
conduttività termica/thermal conductivity/conductividad térmica EPS 35-100 Fix R: **0.035 W/(m·K)**
conduttività termica/thermal conductivity/conductividad térmica converto 31 BW Fix: **0.031 W/(m·K)**
reazione al fuoco del sistema/system reaction to fire/reacción del sistema al fuego: **Euroclass B, s1, d0**
resistenza al passaggio del vapore/resistance to vapour diffusion/resistencia al paso del vapor: **$\mu = 30-70$**

Soluzione ideale per qualificare energeticamente rispondendo a particolari esigenze estetiche nel modo tecnicamente più corretto e sicuro: un involucro in pietra naturale ricostruita dalla forte caratterizzazione, evocativo della tradizione ma estremamente moderno.

Le lastre isolanti di questo sistema soddisfano i requisiti CAM (Criteri Ambientali Minimi).

**Sistema dotato di certificazione
ETA-23/0221**

Ideal solution for energy upgrading that meets specific aesthetic requirements in a safe, technically correct manner. The strong personality of this envelope of reconstituted natural stone evokes traditional construction and yet is extremely modern.

This system's insulation slabs are in compliance with the requirements of the Minimum Environmental Criteria (CAM) for building.

ETA-23/0221 and BBA certified system

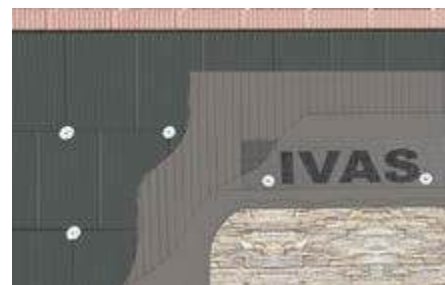

Solución ideal para una calificación energética que responde a particulares exigencias estéticas del modo técnicamente más correcto y seguro: un envoltorio de piedra natural reconstruida, fuertemente caracterizado, que evoca la tradición y al mismo tiempo es extremadamente moderno.

Las placas aislantes de este sistema cumplen con los requisitos CAM (criterios ambientales mínimos).

**Sistema dotato di certificazione
ETA-23/0221 y BBA**















complesso residenziale, **termok8®** grafite plus converto e **termok8®** fenolico, riccone, it













i prodotti

the products

los productos

collanti e rasanti

adhesives and skim coats

colas y morteros de enrasado

klebocem



scheda
tecnica



data
sheet



ficha
técnica



collante/rasante in polvere	interno esterno	adhesive/skim coat in powder form	indoor outdoor	cola/mortero de enrasado en polvo	interior exterior
<p>Adesivo/rasante minerale eco-compatibile in polvere a base di resine insaponificabili, Cemento Portland ad alta resistenza e sabbie selezionate granulometria max 0,6mm. Specifico per l'incollaggio e la rasatura di pannelli isolanti nei cicli termok8 e per ciclo armato Rasoprotection. Uso ristretto agli operatori professionali.</p>		<p>Eco-friendly mineral adhesive/skim coat in powder form made of unsaponifiable resins, high-resistance Portland cement and selected sands with a maximum particle size of 0.6 mm. Specifically formulated for gluing and skimming of insulating panels in termok8 processes and Rasoprotection reinforced process. For strictly professional use.</p>		<p>Adhesivo/mortero de enrasado eco-compatibile en polvo a base de resinas insaponificables, Cemento Portland de alta resistencia y arenas seleccionadas granulometría máx 0,6 mm. Específico para el encolado y enrasado de paneles aislantes en los ciclos termok8 y para ciclo armado Rasoprotection. Uso restringido a usuarios profesionales.</p>	
<p>Granulometria: 0,6 mm Attrezzatura: spatola, cazzuola, frattazzo di spugna, impastatrice a basso numero di giri Rapporto di miscelazione: acqua - 22-24% Consumo: 1,3 kg/m² per mm di spessore; per incollare 4-4,5 kg/m² - per rasare 4-4,5 kg/m²</p>		<p>Particle size: 0.6 mm Equipment: spatula, mason's trowel, sponge trowel, low speed mixer Mixing ratio: water - 22-24%. Recommended use: 1.3 kg/m² per mm of thickness; for gluing 4-4.5 kg/m² - for skimming 4-4.5 kg/m²</p>		<p>Granulometría: 0,6 mm Herramientas: espátula, paleta, llana de esponja, amasadora de bajo número de revoluciones Relación de mezcla : agua - 22-24 % Consumo: 1,3 kg/m² por mm de espesor; para encolar 4-4,5 kg/m² - para enrasar 4-4,5 kg/m²</p>	

tecniche

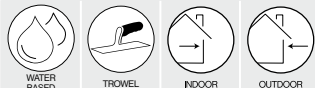

certificazioni

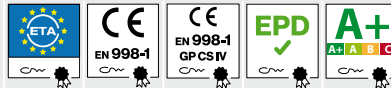

klebocem grosso



scheda
tecnica



data
sheet



ficha
técnica



collante/rasante in polvere	interno esterno	adhesive/skim coat in powder form	indoor outdoor	cola/mortero de enrasado en polvo	interior exterior
<p>Adesivo/rasante minerale eco-compatibile in polvere a base di resine insaponificabili, Cemento Portland ad alta resistenza e sabbie selezionate, granulometria max 1,2mm. Specifico per la rasatura di pannelli isolanti nei cicli termok8 quando è necessario ottenere spessori elevati con l'uso di rete Armatex C1 M o C1 R. Uso ristretto agli operatori professionali.</p>		<p>Eco-friendly mineral adhesive/skim coat in powder form made of unsaponifiable resins, high-resistance Portland cement and selected sands, maximum particle size of 1.2mm. Specifically formulated for skimming insulating panels used in termok8 processes when high thicknesses need to be obtained using an Armatex C1 M or C1 R mesh. For strictly professional use.</p>		<p>Adhesivo/mortero de enrasado eco-compatibile en polvo a base de resinas insaponificables, Cemento Portland de alta resistencia y arenas seleccionadas, granulometría máx. 1,2 mm. Específico para el enrasado de paneles aislantes en los ciclos termok8 cuando es necesario obtener espesores altos con el uso de malla Armatex C1 M o C1 R. Uso restringido a usuarios profesionales.</p>	
<p>Granulometria: 1,2 mm Attrezzatura: spatola, cazzuola, frattazzo di spugna, impastatrice a basso numero di giri Rapporto di miscelazione: acqua 22-24% Consumo: 1,3 kg/m² per mm di spessore; per incollare 4-4,5 kg/m² - per rasare 4-4,5 kg/m²</p>		<p>Particle size: 1.2 mm Equipment: spatula, mason's trowel, sponge trowel, low speed mixer Mixing ratio: water - 22-24%. Recommended use: 1.3 kg/m² per mm of thickness; for gluing 4-4.5 kg/m² - for skimming 4-4.5 kg/m²</p>		<p>Granulometría: 1,2 mm Herramientas: espátula, paleta, llana de esponja, amasadora de bajo número de revoluciones Relación de mezcla : agua - 22-24 % Consumo: 1,3 kg/m² por mm de espesor; para encolar 4-4,5 kg/m² - para enrasar 4-4,5 kg/m²</p>	

tecniche

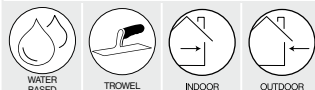

certificazioni

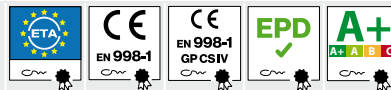

adefix 12 grigio



scheda
tecnica



data
sheet



ficha
técnica



collante/rasante in polvere	interno esterno	adhesive/skim coat in powder form	indoor outdoor	cola/mortero de enrasado en polvo	interior exterior
Adesivo/rasante minerale eco-compatibile in polvere dotato di ottime caratteristiche adesivanti e resistenza ai cicli di gelo e disgelo. A base di resine insaponificabili, Cemento Portland ad alta resistenza e sabbie selezionate. Ottima spatolabilità e riempimento, idoneo per incollaggio, rasature anche armate con rete di rinforzo, su intonaci cavillati, cemento armato, pannelli isolanti. Uso ristretto agli operatori professionali.		Eco-friendly mineral adhesive/skim coat in powder form with superb adhesive properties and resistance to freeze-thaw cycles. Made of unsaponifiable resins, high resistance Portland cement and selected sands. Superb filling capacity and trowel applicability. Suitable for gluing, skim coats (even mesh-reinforced), cracked plaster, reinforced concrete, insulating panels. For strictly professional use.		Adhesivo/rasante mineral eco-compatibile en polvo dotado de óptimas características adhesivas y resistencia a los ciclos de congelación y deshielo. A base de resinas insaponificables, Cemento Portland de alta resistencia y arena seleccionadas. Óptima spatolabilidad y llenado, idóneo para encolado, rasaduras también armadas con red de refuerzo, sobre enlucidos cavilados, hormigón armado, paneles aislantes. Uso restringido a usuarios profesionales.	
Granulometria: 0,8 mm, (Adefix 12 Grigio Grosso: 1,2 mm) Attrezzatura: spatola, cazzuola, frattazzo di spugna, impastatrice a basso numero di giri Rapporto di miscelazione: acqua - 22-24% Consumo: 1,3 kg/m ² per mm di spessore; Per Incollare: 4-4,5 kg/m ² -Per Rasare: 4-4,5 kg/m ²		Particle size: 0.8 mm, (Adefix 12 Grey Coarse: 1.2 mm) Equipment: spatula, mason's trowel, sponge trowel, low speed mixer Mixing ratio: water - 22-24%. Recommended use: 1.3 kg/m ² per mm of thickness; For gluing: 4-4.5 kg/m ² - For Skimming: 4-4.5 kg/m ²		Granulometría: 0,8 mm, (Adefix 12 Gris Grosso: 1,2 mm) Herramientas: espátula, paleta, llana de esponja, amasadora de bajo número de revoluciones Relación de mezcla : agua - 22-24 % Consumo: 1,3 kg/m ² por mm de espesor; Para encolar: 4-4,5 kg/m ² - Para enrasar: 4-4,5 kg/m ²	

tecniche



certificazioni



adefix 12 bianco



scheda
tecnica



data
sheet



ficha
técnica



collante/rasante in polvere bianco	interno esterno	white adhesive/skim coat in powder form	indoor outdoor	cola/mortero de enrasado en polvo blanco	interior exterior
Adesivo/rasante minerale eco-compatibile in polvere dotato di ottime caratteristiche adesivanti e resistenza ai cicli di gelo e disgelo. A base di resine insaponificabili, Cemento Bianco ad alta resistenza e sabbie selezionate. Ottima spatolabilità e riempimento, idoneo per incollaggio, rasature anche armate con rete di rinforzo, su intonaci cavillati, cemento armato, pannelli isolanti. Uso ristretto agli operatori professionali.		Eco-friendly mineral adhesive/skim coat in powder form with superb adhesive properties and resistance to freeze-thaw cycles. Made of unsaponifiable resins, high resistance White Cement and selected sands. Superb filling capacity and trowel applicability. Suitable for gluing, skim coats (even mesh-reinforced), cracked plaster, reinforced concrete, insulating panels. For strictly professional use.		Adhesivo/rasante mineral eco-compatibile en polvo dotado de óptimas características adhesivas y resistencia a los ciclos de congelación y deshielo. A base de resinas insaponificables, Cemento Blanco de alta resistencia y arenas seleccionadas. Óptima spatolabilidad y llenado, idóneo para encolado, rasaduras también armadas con red de refuerzo, sobre enlucidos cavilados, hormigón armado, paneles aislantes. Uso restringido a usuarios profesionales.	
Granulometria: 0,8 mm (Adefix 12 Bianco Grosso: 1,2 mm) Attrezzatura: spatola, cazzuola, frattazzo di spugna, impastatrice a basso numero di giri Rapporto di miscelazione: acqua - 22-24% Consumo: 1,3 kg/m ² per mm di spessore; Per Incollare: 4-4,5 kg/m ² -Per Rasare: 4-4,5 kg/m ²		Particle size: 0.8 mm (Adefix 12 white coarse: 1.2 mm) Equipment: spatula, mason's trowel, sponge trowel, low speed mixer Mixing ratio: water - 22-24%. Recommended use: 1.3 kg/m ² per mm of thickness; For gluing: 4-4.5 kg/m ² - For Skimming: 4-4.5 kg/m ²		Granulometría: 0,8 mm (Adefix 12 Blanco Grosso: 1,2 mm) Herramientas: espátula, paleta, llana de esponja, amasadora de bajo número de revoluciones Relación de mezcla : agua - 22-24 % Consumo: 1,3 kg/m ² por mm de espesor; Para encolar: 4-4,5 kg/m ² - Para enrasar: 4-4,5 kg/m ²	

tecniche



certificazioni





collante/rasante plas- tico in pasta	esterno	plastic adhesive/skim coat in paste form	outdoor	cola/mortero de enrasado plástico en pasta	exterior
<p>Collante/rasante plastico in pasta specifico per polistirene espanso estruso, fibre minerali e lana di vetro. A base di resine in dispersione insaponificabili e sabbie selezionate, dotato di ottime caratteristiche adesivanti, idoneo per rasature armate con rete di rinforzo su intonaci cavillati, cemento, polistirolo espanso ed estruso, lana di vetro e quale collante per lastre di polistirolo in genere e in fibre minerali per termok8. Uso ristretto agli operatori professionali.</p>		<p>Plastic adhesive/skim coat in paste form, specific for extruded polystyrene foam, mineral fibres and glass fibres. Based on unsaponifiable resins in dispersion and selected sands, provides excellent adhesive properties. Ideal for mesh-reinforced skim coats on cracked plasters, cement, extruded polystyrene foam, glass fibre and as an adhesive for sheets of polystyrene in general and mineral fibres for termok8 system. For strictly professional use.</p>		<p>Cola/mortero de enrasado plástico en pasta específico para poliestireno expandido extruido, fibras minerales y lana de vidrio. A base de resinas insaponificables en dispersión y arenas seleccionadas, dotado de excelentes características de adhesión, idóneo para enrasados armados con malla de refuerzo sobre enfoscados cuarteados, cemento, poliestireno expandido y extruido, lana de vidrio, y como cola para placas de poliestireno en general y en fibras minerales para termok8. Uso restringido a usuarios profesionales.</p>	
<p>Granulometria: <0,5 mm Attrezzatura: spatola, cazzuola, impastatrice a basso numero di giri Rapporto di miscelazione: Cemento PTL 325 - 100% Consumo: 1,3 kg/m² per mm di spessore; Per Incollare: 4-4,5 kg/m² - Per Rasare: 4-4,5 kg/m²</p>		<p>Particle size: <0.5 mm Equipment: spatula, mason's trowel, low speed mixer. Mixing ratio: PTL cement 325 - 100% Recommended use: 1.3 kg/m² per mm of thickness; For gluing: 4-4.5 kg/m² - For Skimming: 4-4.5 kg/m²</p>		<p>Granulometría: <0,5 mm Herramientas: espátula, paleta, amasadora de bajo número de revoluciones Relación de mezcla: Cemento PTL 325 - 100 % Consumo: 1,3 kg/m² por mm de espesor; Para encolar: 4-4,5 kg/m² - Para enrasar: 4-4,5 kg/m²</p>	

tecniche



collanti e rasanti ht

ht adhesives and skim coats

colas y morteros de enrasado ht



collante/rasante termico in polvere	interno esterno	thermal adhesive/skim coat in powder form	indoor outdoor	cola/mortero de enrasado térmico en polvo	interior exterior
<p>Adesivo/rasante minerale eco-compatibile ad elevata prestazione termica con ottime caratteristiche adesivanti e di resistenza ai cicli di gelo e disgelo. Collante/rasante in polvere alleggerito con sfere di vetro cavo a base di Cemento Portland ad alta resistenza, sabbie selezionate e resine insaponificabili. Idoneo per l'incollaggio di pannelli isolanti nei cicli termok8, per rasature, rasature armate con rete di rinforzo, su intonaci cavillati, cemento armato. Uso ristretto agli operatori professionali.</p>		<p>Eco-friendly mineral adhesive/skim coat in powder form with high thermal performance, superb adhesive properties and resistance to freeze-thaw cycles. Adhesive/skim coat in powder form made of high resistance Portland cement, lightened with hollow glass beads, selected sands and unsaponifiable resins. Suitable for gluing insulating panels in termok8 processes, for skimming, applying mesh-reinforced skim coats on cracked plaster, reinforced concrete. For strictly professional use.</p>		<p>Adhesivo/mortero de enrasado mineral eco-compatible de altas prestaciones térmicas con excelentes características de adhesión y resistencia a los ciclos de hielo y deshielo. Cola/mortero de enrasado en polvo aligerado con esferas de vidrio hueco, a base de Cemento Portland de alta resistencia, arenas seleccionadas y resinas insaponificables. Idóneo para el encolado de paneles aislantes en los ciclos termok8, para enrasados, enrasados armados con malla de refuerzo, sobre enfoscados cuarteados, hormigón armado. Uso restringido a usuarios profesionales.</p>	
<p>Granulometria: 1 mm Attrezzatura: spatola, cazzuola, frattazzo di spugna, impastatrice a basso numero di giri Rapporto di miscelazione: acqua 31/32% Consumo: 0,9 kg/m² per mm di spessore; Per Incollare: 2,7-3,2 kg/m² - Per Rasare: 2,7-3,2 kg/m²</p>		<p>Particle Size: 1 mm Equipment: spatula, mason's trowel, sponge trowel, low speed mixer Mixing ratio: water - 31/32%. Recommended use: 0.9 kg/m² per mm of thickness; For gluing: 2.7-3.2 kg/m² - For Skimming: 2.7-3.2 kg/m²</p>		<p>Granulometría: 1 mm Herramientas: espátula, paleta, llana de esponja, amasadora de bajo número de revoluciones Relación de mezcla: agua - 31/32 % Consumo: 0,9 kg/m² por mm de espesor; Para encolar: 2,7-3,2 kg/m² - Para enrasar: 2,7-3,2 kg/m²</p>	

tecniche

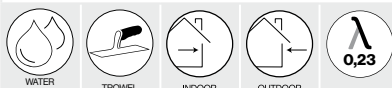

certificazioni

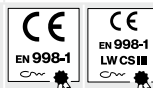

klebocem fibrato



scheda
tecnica



data
sheet



ficha
técnica



collante/rasante fibrorinforzato	interno esterno	fibre-reinforced adhesive/skim coat	indoor outdoor	cola/mortero de enrasado fibrorreforzado	interior exterior
<p>Adesivo/rasante minerale eco-compatibile in polvere additivato con fibre poliammidiche, con ottime caratteristiche adesivanti e resistenza ai cicli di gelo e disgelo. Particolarmente indicato per rasature armate su intonaci cavillati e cemento armato. Idoneo anche come rasante nei cicli termok8. Prodotto verificato secondo le norme UNI EN 998-1 per l'uso del marchio CE. Uso ristretto agli operatori professionali.</p>		<p>Eco-friendly mineral adhesive/skim coat in powder form with the addition of polyamide fibres. Superb adhesive properties and resistance to freeze-thaw cycles. Particularly suitable for reinforced skim coats applied on cracked plaster and reinforced concrete. Also suitable as skim coat For the termok8 processes. Product tested according to UNI EN 998-1 for use of CE marking. For strictly professional use.</p>		<p>Adhesivo/mortero de enrasado mineral eco-compatibile en polvo con aditivo de fibras poliamidicas, dotado de excelentes características de adhesión y resistencia a los ciclos de hielo y deshielo. Particolarmente indicado para enrasados armados sobre enfoscados cuarteados y hormigón armado. Idóneo también como mortero de enrasado en los ciclos termok8. Producto verificado conforme a las normas UNI EN 998-1 para el uso de la marca CE. Uso restringido a usuarios profesionales.</p>	
<p>Granulometria: max 0,6 mm Attrezzatura: spatola, cazzuola, frattazzo di spugna, impastatrice a basso numero di giri Rapporto di miscelazione: acqua - 22-24% Consumo: 1,3 kg/m² per mm di spessore; Per Incollare: 4-4,5 kg/m² - Per Rasare: 4-4,5 kg/m²</p>		<p>Particle Size: max 0.6 mm Equipment: spatula, mason's trowel, sponge trowel, low speed mixer Mixing ratio: water - 22-24%. Recommended use: 1.3 kg/m² per mm of thickness; For gluing: 4-4.5 kg/m² - For Skimming: 4-4.5 kg/m²</p>		<p>Granulometría: máx. 0,6 mm Herramientas: espátula, paleta, llana de esponja, amasadora de bajo número de revoluciones Relación de mezcla : agua - 22-24 % Consumo: 1,3 kg/m² por mm de espesor; Para encolar: 4-4,5 kg/m² - Para enrasar: 4-4,5 kg/m²</p>	

tecniche

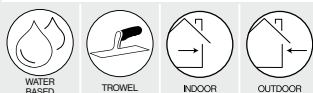

certificazioni



klebocem ultra



scheda
tecnica



data
sheet



ficha
técnica



collante/rasante per termok8 Modulari	interno esterno	adhesive/skim coat for termok8 modular systems	indoor outdoor	cola/mortero de enrasado para termok8 Modulares	interior exterior
<p>Adesivo/rasante minerale eco-compatibile ad adesione migliorata a base di resine insaponificabili, Cemento Portland ad alta resistenza e sabbie selezionate. Possiede ottime caratteristiche adesivanti e resistenza ai cicli di gelo e disgelo. Idoneo per incollare e rasare i pannelli isolanti tipo FIX per termok8 Modulari. Uso ristretto agli operatori professionali.</p>		<p>Eco-friendly mineral adhesive/skim coat with adhesion properties boosted by the use of unsaponifiable resins, high-resistance Portland cement and selected sands. It offers superb adhesive properties and resistance to freeze-thaw cycles. Suitable for gluing and skimming FIX-type insulating panels For the termok8: modular systems. For strictly professional use.</p>		<p>Adhesivo/mortero de enrasado mineral eco-compatibile de adhesión mejorada a base de resinas insaponificables, Cemento Portland de alta resistencia y arenas seleccionadas. Posee excelentes características de adhesión y resistencia a los ciclos de hielo y deshielo. Idóneo para encolar y enrasar paneles aislantes tipo FIX para termok8 Modulares. Uso restringido a usuarios profesionales.</p>	
<p>Granulometria: max 0,8 mm Attrezzatura: spatola, cazzuola, frattazzo di spugna, impastatrice a basso numero di giri Rapporto di miscelazione: acqua - 22-24% Consumo: 1,3 kg/m² per mm di spessore; Per Incollare: 4-4,5 kg/m² - Per Rasare: 4-4,5 kg/m²</p>		<p>Particle Size: max 0.8 mm Equipment: spatula, mason's trowel, sponge trowel, low speed mixer Mixing ratio: water - 22-24%. Recommended use: 1.3 kg/m² per mm of thickness; For gluing: 4-4.5 kg/m² - For Skimming: 4-4.5 kg/m²</p>		<p>Granulometría: máx. 0,8 mm Herramientas: espátula, paleta, llana de esponja, amasadora de bajo número de revoluciones Relación de mezcla : agua - 22-24 % Consumo: 1,3 kg/m² por mm de espesor; Para encolar: 4-4,5 kg/m² - Para enrasar: 4-4,5 kg/m²</p>	

tecniche

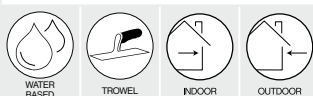

certificazioni

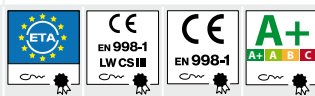

klebocem minerale



scheda
tecnica



data
sheet



ficha
técnica



collante/rasante per termok8 minerali	interno esterno	adhesive/skim coat for mineral termok8 systems	indoor outdoor	cola/mortero de enrasado para termok8 minerales	interior exterior
<p>Adesivo/rasante minerale eco-compatibile in polvere particolarmente indicato nei rivestimenti a cappotto di tipo minerale e per isolanti bio-compatibili. Specifico per l'incollaggio di pannelli isolanti naturali o minerali (sughero, lana di roccia, lana di vetro, ecc.) utilizzabile anche su pannelli in EPS bianco o grigio nei cicli termok8. Uso ristretto agli operatori professionali.</p>		<p>Eco-friendly mineral adhesive/skim coat in powder form particularly suitable for mineral-based external thermal insulation systems and eco-compatible insulation. Specific for gluing natural or mineral insulating panels (cork, rock wool, glass fibre, etc.). Can also be used on white or grey EPS panels in the termok8 processes. For strictly professional use.</p>		<p>Adhesivo/mortero de enrasado mineral eco-compatibile en polvo particularmente indicado para revestimientos por capas de tipo mineral y para aislantes bio-compatibles. Especifico para el encolado de paneles aislantes naturales o minerales (corcho, lana de roca, lana de vidrio, etc.), utilizable también con paneles de EPS blanco o gris en los ciclos termok8. Uso restringido a usuarios profesionales.</p>	
<p>Granulometria: max 0,6 mm Attrezzatura: spatola, cazzuola, frattazzo di spugna, impastatrice a basso numero di giri Rapporto di miscelazione: acqua 22-24% Consumo: 1,3 kg/m² per mm di spessore; Per Incollare: 4-4,5 kg/m² - Per Rasare: 4-4,5 kg/m²</p>		<p>Particle Size: max 0.6 mm Equipment: spatula, mason's trowel, sponge trowel, low speed mixer Mixing ratio: water - 22-24%. Recommended use: 1.3 kg/m² per mm of thickness; For gluing: 4-4.5 kg/m² - For Skimming: 4-4.5 kg/m²</p>		<p>Granulometría: máx. 0,6 mm Herramientas: espátula, paleta, llana de esponja, amasadora de bajo número de revoluciones Relación de mezcla : agua - 22-24 % Consumo: 1,3 kg/m² por mm de espesor; Para Encolar: 4-4,5 kg/m² - Para enrasar: 4-4,5 kg/m²</p>	

tecniche

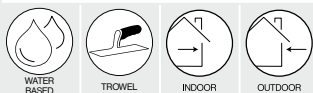

certificazioni

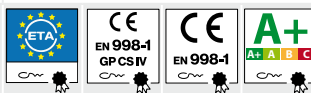

klebocalce naturale



scheda
tecnica



data
sheet



ficha
técnica



collante/rasante a base di calce idraulica	interno esterno	hydraulic lime-based adhesive/skim coat	indoor outdoor	cola/mortero de enrasado a base de cal hidráulica	interior exterior
<p>Collante/rasante a base di Calce Idraulica specifico per l'incollaggio e la rasatura di pannelli isolanti naturali o minerali nei cicli termok8. Il prodotto unisce la lavorabilità e traspirabilità della Calce Idraulica Naturale (Natural Hydraulic Lime 3.5, UNI-EN 459-1_2010), a quelle di forza e rapidità di presa del Roman Cement (Ciment Prompt Naturel, NF P 15-314). Totalmente 'Portland Free', rappresenta la soluzione ideale per l'edilizia verde e il recupero architettonico. Uso ristretto agli operatori professionali.</p>		<p>Hydraulic lime-based adhesive/skim coat specifically designed for gluing and skimming natural or mineral insulating panels in termok8 processes. The product blends the workability and breathability of Natural Hydraulic Lime (Natural Hydraulic Lime 3.5, UNI-EN 459-1_2010) with the fast setting properties of Roman Cement (Ciment Prompt Naturel, NF P 15-314). Totally 'Portland Free'. The ideal solution for green construction and architectural renovation. For strictly professional use.</p>		<p>Cola/mortero de enrasado a base de cal hidráulica, específica para el encolado y el enrasado de paneles aislantes naturales o minerales en los ciclos termok8. El producto une la facilidad de elaboración y transpirabilidad de la Cal Hidráulica Natural (Natural Hydraulic Lime 3.5, UNI-EN 459-1_2010), a las de fuerza y rapidez de fraguado del Roman Cement (Ciment Prompt Naturel, NF P 15-314). Totalmente 'Portland Free', representa la solución ideal para la construcción ecológica y la recuperación arquitectónica. Uso restringido a usuarios profesionales.</p>	
<p>Granulometria: max 0,6 mm Attrezzatura: spatola, cazzuola, frattazzo di spugna, impastatrice a basso numero di giri Rapporto di miscelazione: acqua -30-32% Consumo: 1,1 kg/m² per mm di spessore; Per Incollare: 3,5-4 kg/m² - Per Rasare: 3,5-4 kg/m²</p>		<p>Particle Size: max 0.6 mm Equipment: spatula, mason's trowel, sponge trowel, low speed mixer Mixing ratio: water -30-32%. Recommended use: 1.1 kg/m² per mm of thickness; For gluing: 3.5-4 kg/m² For Skimming: 3.5-4 kg/m²</p>		<p>Granulometría: máx. 0,6 mm Herramientas: espátula, paleta, llana de esponja, amasadora de bajo número de revoluciones Relación de mezcla: agua -30-32% Consumo: 1,1 kg/m² por mm de espesor; Para encolar: 3,5-4 kg/m² - Para enrasar: 3,5-4 kg/m²</p>	

tecniche

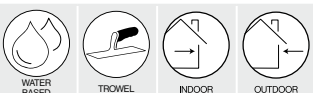

certificazioni

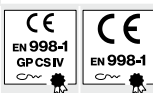



rasante cementizio elastomerico	interno esterno	elastomeric cement-based skim coat	indoor outdoor	mortero de cemento elastomérico	interior exterior
<p>Rasante plastico in pasta da additivarsi con cemento PTL 325 a base di resine in dispersione insaponificabili e sabbie selezionate, dotato di ottime caratteristiche adesivanti, ottima spatolabilità e riempimento. L'additivazione con resine elastomeriche lo rende idoneo per rasature anche armate con rete di rinforzo Armatex all'interno del ciclo Rasoprotection. Uso ristretto agli operatori professionali.</p>		<p>Plastic skim coat in paste form to which PTL 325 cement is to be added. Contains unsaponifiable resins in dispersion and selected sands. Offers excellent adhesion, filling capacity and trowel applicability properties. The addition of elastomeric resins makes it suitable for skimming, even when Armatex reinforcement mesh is used with the Rasoprotection process. For strictly professional use.</p>		<p>Mortero de enrasado plástico en pasta, para aditivar con cemento PTL 325 a base de resinas en dispersión insaponificables y arenas seleccionadas, dotado de excelentes características de adhesión, excelente facilidad para la extensión con espátula y para relleno. El aditivado con resinas elastoméricas lo hace idóneo para enrasados incluso armados con malla de refuerzo Armatex dentro del ciclo Rasoprotection. Uso restringido a usuarios profesionales.</p>	
<p>Granulometria: max 1 mm Attrezzatura: spatola, cazzuola, frattazzo di spugna, impastatrice a basso numero di giri Rapporto di miscelazione: 30% con cemento PTL 325 Resa: 1 kg/m² per mm di spessore; Per Rasare: 3-3,5 kg/m² Colore: grigio</p>		<p>Particle Size: max 1 mm Equipment: spatula, mason's trowel, sponge trowel, low speed mixer Mixing ratio: 30% with PTL 325 cement Coverage: 1 Kg/ m² per mm of thickness; For skimming: 3-3.5 kg/m² Color: grey</p>		<p>Granulometría: máx. 1 mm Herramientas: espátula, paleta, llana de esponja, amasadora de bajo número de revoluciones Relación de mezcla: 30% con cemento PTL 325 Rendimiento: 1 kg/m² por mm de espesor; Para enrasar: 3-3,5 kg/m² Color: gris</p>	

tecniche



WATER
BASED



TROWEL



INDOOR



OUTDOOR

Termok8® foam



scheda
tecnica



data
sheet



ficha
técnica



schiuma adesiva poliuretanică	esterno	polyurethane adhesive foam	outdoor	espuma adhesiva poliuretánica	exterior
<p>Adesivo in schiuma poliuretanică studiato per il fissaggio di pannelli di polistirolo espanso alle pareti esterne di edifici per l'isolamento termico, per davanzali. Caratterizzato da un'eccellente adesione su molti materiali come cemento, intonaco, mattoni, legno, metallo, polistirolo espanso XPS polistirolo ed estruso. Uso ristretto agli operatori professionali.</p>		<p>Polyurethane foam adhesive designed to secure expanded polystyrene panels to outside walls to achieve thermal building insulation, for window sills. It adheres well to many materials such as concrete, plaster, brick, wood, metal, polystyrene foam, XPS extruded polystyrene foam. For strictly professional use.</p>		<p>Adhesivo en espuma poliuretánica estudiado para la fijación de paneles de poliestireno expandido a las paredes externas de edificios para el aislamiento térmico; para alféizares. Se caracteriza por una excelente adhesión sobre muchos materiales como cemento, enfoscados, ladrillos, metal, poliestireno expandido XPS y poliestireno extruido. Uso restringido a usuarios profesionales.</p>	
<p>Diluizione: pronto all'uso Confezione: 1 scatola da 12 pezzi da 0,750 ml</p>		<p>Dilution: ready to use Package: 1 box da 12 pezzi da 0,750 ml</p>		<p>Dilución: listo para usar Envase: 1 caja de 12 piezas de 0,750 ml</p>	

sigil pol



scheda
tecnica



data
sheet



ficha
técnica



sigillante elastico sovraverniciabile	flexible sealant that can be overpainted	sellador elástico, admite recubrimiento de pintura
<p>Sigillante elastico Poliuretanică mono-componente igroindurente, sovraverniciabile.</p>	<p>One-pack, elastic, moisture-hardening polyurethane sealant. Can be overpainted.</p>	<p>Sellador elástico Poiluretánico mono-componente higoendurecible, admite recubrimiento de pintura.</p>
<p>Applicazione: estrusori pneumatici o manuali Resa: 100-150 g/m/cm²</p>	<p>Application: pneumatic or manual extruder Coverage: 100-150 g/m/cm²</p>	<p>Aplicación: extrusores neumáticos o manuales Rendimiento: 100-150 g/m²</p>

collanti fuganti per modulari

adhesives and grouts for modular systems

colas de rejuntado para modulares

glueflex modular big grigio



scheda
tecnica



data
sheet



ficha
técnica



adesivo cementizio bicomponente grigio	interno esterno	two-pack cement-based adhesive - grey	indoor outdoor	adhesivo cementoso bicomponente gris	interior exterior
Adesivo cementizio bicomponente A (polvere cementizia) B (resina elasticizzante), specifico per la posa a pavimento e a parete di piastrelle ceramiche (grès porcellanato, cotto, klinker, ecc.), materiale lapideo e mosaici, non assorbenti, di grande formato. Resistenza all'umidità: ottima. Resistenza ai solventi e acidi: ottima. Uso ristretto agli operatori professionali.		Two-pack cement-based adhesive — A (cement powder) B (elasticizing resin) — specifically formulated for laying of large, non-absorbent ceramic (porcelain stoneware, terracotta, klinker, etc.), stone and mosaic wall and floor tiles. Moisture resistance: excellent. Resistance to solvents and acids: excellent For strictly professional use.		Adhesivo cementoso bicomponente A (polvo de cemento) B (resina elástica), específico para la colocación en suelos y paredes de baldosas cerámicas (gres porcelánico, barro cocido, klinker, etc.), material lapideo y mosaicos, no absorbentes, de gran formato. Resistencia a la humedad: excelente. Resistencia a los disolventes y ácidos: excelente. Uso restringido a usuarios profesionales.	
Granulometria: max 0,5 mm Attrezzatura: spatola dentata, cazzuola, impastatrice a basso numero di giri Rapporto di miscelazione: 30% con componente B - 7,6 kg per confezione da 25 Kg Consumo: Mosaici Piccoli formati 2 kg/m ² - standard 2,5–3,5 2 kg/m ² - Grandi 5,5–6,5 2 kg/m ² Per sistema: termok8 Modular Big		Particle Size: max 0.5 mm Equipment: serrated spatula, mason's trowel, low speed mixer. Mixing ratio: 30% with component B - 7.6 kg for 25 kg package Recommended use: Small mosaic tiles 2 kg/m ² - standard 2.5-3.5 2 kg/m ² - Large 5.5-6.5 2 kg/m ² For: termok8 Modular Big system		Granulometría: máx. 0,5 mm Herramientas: espátula dentada, paleta, amasadora de bajo número de revoluciones Relación de mezcla: 30 % con componente B - 7,6 kg por envase de 25 Kg Consumo: Mosaicos de pequeño formato 2 kg/m ² - estándar 2,5–3,5 2 kg/m ² - Grandes 5,5–6,5 2 kg/m ² Para sistema: termok8 Modular Big	

tecniche

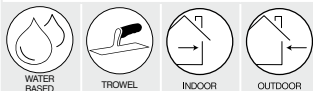

certificazioni

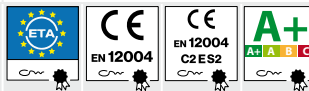

glueflex modular big bianco



scheda
tecnica



data
sheet



ficha
técnica



adesivo cementizio bicomponente bianco	interno esterno	two-pack cement-based adhesive - white	indoor outdoor	adhesivo cementoso bicomponente blanco	interior exterior
Adesivo cementizio bicomponente A (polvere cementizia) B (resina elasticizzante), specifico per la posa a pavimento e a parete di piastrelle ceramiche (grès porcellanato, cotto, klinker, ecc.), materiale lapideo e mosaici, non assorbenti, di grande formato. Resistenza all'umidità: ottima. Resistenza ai solventi e acidi: ottima. Uso ristretto agli operatori professionali.		Two-pack cement-based adhesive — A (cement powder) B (elasticizing resin) — specifically formulated for laying of large, non-absorbent ceramic (porcelain stoneware, terracotta, klinker, etc.), stone and mosaic wall and floor tiles. Moisture resistance: excellent. Resistance to solvents and acids: excellent For strictly professional use.		Adhesivo cementoso bicomponente A (polvo de cemento) B (resina elástica), específico para la colocación en suelos y paredes de baldosas cerámicas (gres porcelánico, barro cocido, klinker, etc.), material lapideo y mosaicos, no absorbentes, de gran formato. Resistencia a la humedad: excelente. Resistencia a los disolventes y ácidos: excelente. Uso restringido a usuarios profesionales.	
Granulometria: max 0,5 mm Attrezzatura: spatola dentata, cazzuola, impastatrice a basso numero di giri Rapporto di miscelazione: 30% con componente B - 7,6 kg per confezione da 25 Kg Consumo: Mosaici Piccoli formati 2 kg/m ² - standard 2,5–3,5 2 kg/m ² - Grandi 5,5–6,5 2 kg/m ² Per sistema: termok8 Modular Big		Particle Size: max 0.5 mm Equipment: serrated spatula, mason's trowel, low speed mixer. Mixing ratio: 30% with component B - 7.6 kg for 25 kg package Recommended use: Small mosaic tiles 2 kg/m ² - standard 2.5-3.5 2 kg/m ² - Large 5.5-6.5 2 kg/m ² For: termok8 Modular Big system		Granulometría: máx. 0,5 mm Herramientas: espátula dentada, paleta, amasadora de bajo número de revoluciones Relación de mezcla: 30 % con componente B - 7,6 kg por envase de 25 Kg Consumo: Mosaicos de pequeño formato 2 kg/m ² - estándar 2,5–3,5 2 kg/m ² - Grandes 5,5–6,5 2 kg/m ² Para sistema: termok8 Modular Big	

tecniche

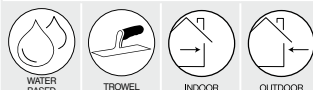

certificazioni

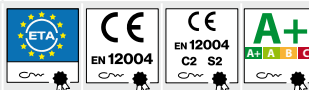



adesivo in pasta pronto uso	interno esterno	ready-to-use adhesive in paste form	indoor outdoor	adhesivo en pasta listo para usar	interior exterior
<p>Adesivo in pasta specifico per l'incollaggio e la stuccatura di fughe fra rivestimenti modulari tipo Listello Flex. Ottima lavorabilità, sovraverniciabile, permeabile al vapore acqueo, colorazioni stabili, idoneo solo per lavorazioni a strato sottile. Uso ristretto agli operatori professionali</p>		<p>Adhesive in paste form specific for gluing and filling joints between modular cladding, such as Flex slips. Very good workability, water vapour permeability, stable colours. Can be overpainted. Suitable only for working in thin-layers. For strictly professional use</p>		<p>Adhesivo en pasta específico para el encolado y emplaste de juntas entre revestimientos modulares tipo Listel Flex. Se trabaja con facilidad, admite recubrimiento de pintura, permeable al vapor de agua, coloraciones estables, idóneo solo para aplicaciones en capa fina. Uso restringido a usuarios profesionales.</p>	
<p>Attrezzatura: Spatola dentata con dentatura 4x4mm, 4x6mm o 5x5mm, pennello da 10mm Rapporto di miscelazione: pronto uso Consumo: 2.5-3.4 kg/m²</p>		<p>Equipment: Serrated spatula with 4x4mm, 4x6mm or 5x5mm serration, 10mm brush Mixing ratio: ready to use Recommended use: 2.5-3.4 kg/m²</p>		<p>Herramientas: Espátula dentada con dientes de 4x4 mm, 4x6 mm o 5x5 mm, brocha de 10 mm Relación de mezcla: listo para usar Consumo: 2,5-3,4 kg/m²</p>	

tecniche

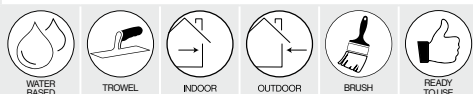

sigillante per fughe grigio	interno esterno	joint sealant - grey	indoor outdoor	sellador para juntas gris	interior exterior
<p>Malta cementizia, idrofugata nella massa per la stuccatura di fughe fra i listelli tipo facciavista fatti a mano in pasta "molla" su pannelli isolanti. Prodotto monocomponente, costituito da una miscela in polvere di cemento, inerti calcarei e silicei selezionati e in granulometria calibrata. Possiede ottime caratteristiche di adesione e resistenza ai cicli di gelo e disgelo. Uso ristretto agli operatori professionali.</p>		<p>Cement-based mortar, waterproofed in the mass, for filling the joints of hand-made fair-faced brick slips on insulating panels. One-pack product, consisting of a powdered mixture of cement, selected calcareous and silica inert materials of calibrated particle size. They offer superb adhesion properties and resistance to freeze-thaw cycles. For strictly professional use.</p>		<p>Mortero de cemento, hidrófugo de masa para emplastar las juntas de listeles tipo facciavista hechos a mano en pasta "blanda" sobre paneles aislantes. Producto monocomponente, constituido por una mezcla en polvo de cemento, áridos silíceos y calcáreos seleccionados y en granulometría calibrada. Poseen excelentes características de adhesión y resistencia a los ciclos de hielo y deshielo. Uso restringido a usuarios profesionales.</p>	
<p>Granulometria: max 1,2 mm Attrezzatura: betoniera, spatola, impastatrice a basso numero di giri, cazzuola, ferro da giunti Rapporto di miscelazione: acqua - 17-19% Consumo: non stimabile, dipende dal listello e dalla fuga</p>		<p>Particle Size: max 1.2 mm Equipment: cement mixer, spatula, low speed mixer, mason's trowel, brick jointer Mixing ratio: water - 17-19%. Recommended use: cannot be estimated, depends on the slip and joint</p>		<p>Granulometría: máx. 1,2 mm Herramientas: hormigonera, espátula, amasadora de bajo número de revoluciones, paleta, hierro para juntas Relación de mezcla: agua - 17-19% Consumo: no admite estimaciones, depende del listel y de la junta</p>	

tecniche



certificazioni





sigillante per fughe beige	interno esterno	joint sealant - beige	indoor outdoor	sellador para juntas beige	interior exterior
<p>Malta cementizia, idrofugata nella massa, per la stuccatura di fughe fra i listelli tipo facciavista fatti a mano in pasta "molla" su pannelli isolanti. Prodotto monocomponente, costituito da una miscela in polvere di calce, cemento, inerti calcarei e silicei selezionati e in granulometria calibrata. Possiede ottime caratteristiche di adesione e resistenza ai cicli di gelo e disgelo. Uso ristretto agli operatori professionali.</p>		<p>Cement-based mortar, waterproofed in the mass, for filling the joints of hand-made fair-faced brick slips on insulating panels. One-pack product, consisting of a powdered mixture of lime, cement, selected calcareous and silica inert materials of calibrated particle size. They offer superb adhesion properties and resistance to freeze-thaw cycles. For strictly professional use.</p>		<p>Mortero de cemento, hidrófugo de masa para emplastar las juntas de listeles tipo facciavista hechos a mano en pasta "blanda" sobre paneles aislantes. Producto monocomponente, constituido por una mezcla en polvo de cal, cemento, áridos calcáreos y silíceos seleccionados y en granulometría calibrada. Poseen excelentes características de adhesión y resistencia a los ciclos de hielo y deshielo. Uso restringido a usuarios profesionales.</p>	
<p>Granulometria: max 1,2 mm Attrezzatura: betoniera, spatola, impastatrice a basso numero di giri, cazzuola, ferro da giunti Rapporto di miscelazione: acqua 17-19% Consumo: non stimabile, dipende dal listello e dalla fuga</p>		<p>Particle Size: max 1.2 mm Equipment: cement mixer, spatula, low speed mixer, mason's trowel, brick jointer Mixing ratio: water - 17-19%. Recommended use: cannot be estimated, depends on the slip and joint</p>		<p>Granulometría: máx. 1,2 mm Herramientas: hormigonera, espátula, amasadora de bajo número de revoluciones, paleta, hierro para juntas Relación de mezcla: agua - 17-19% Consumo: no admite estimaciones, depende del listel y de la junta</p>	

tecniche



certificazioni

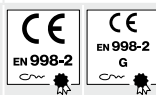

isolanti eps riciclato

insulation recycled eps

aislantes eps reciclado



pannello in EPS additivato di grafite detensionato	unstressed EPS panel with the addition of graphite	panel en EPS destensado con aditivo de grafito
<p>Pannello isolante detensionato idoneo per l'applicazione a cappotto ETICS, realizzato in polistirene espanso sinterizzato di colore grigio. Realizzato con un contenuto di riciclato $\geq 10\%$. Omologato secondo EAD 040083-00-0404 già ETAG 004. Disponibile anche in versione fugato sagomato (fughe decorative).</p>	<p>Unstressed insulation panel suitable for ETICS external thermal insulation systems, made of grey sintered expanded polystyrene. Made with $\geq 10\%$ recycled content. Approved according to EAD 040083-00-0404 (formerly ETAG 004). Also available in grooved versions (decorative groovings).</p>	<p>Panel aislante destensado idóneo para la aplicación por capas SATE, realizado en poliestireno expandido sinterizado de color gris. Realizado con un contenido de reciclado $\geq 10\%$. Homologado según EAD 040083-00-0404, antes ETAG 004. Disponibile también en versión perfilada (con ranuras decorativas).</p>
<p>Per sistema termok8: Grafite Plus Converto Formato: 100 x 50 cm Spessore: da 2 a 20 cm Resistenza a trazione: TR ≥ 100 kPa Classe reazione fuoco del sistema Termok8: B-s1,d0</p>	<p>For system termok8: Grafite Plus Converto Size: 100 x 50 cm Thickness: from 2 to 20 cm Tensile strength: TR ≥ 100 kPa Termok8 system fire reaction class: B-s1,d0</p>	<p>Para sistema termok8: Grafite Plus Converto Medidas: 100 x 50 cm Espesor: de 2 a 20 cm Resistencia a la tracción: TR ≥ 100 kPa Clase de reacción al fuego del sistema Termok8: B-s1,d0</p>

tecniche



certificazioni



converto 31-G plus





scheda
tecnica



data
sheet



ficha
técnica

 	<p>pannello in EPS additivato di grafite detensionato</p> <p>Pannello isolante detensionato idoneo per l'applicazione a cappotto ETICS, realizzato in polistirene espanso sinterizzato di colore grigio. Omologato secondo EAD 040083-00-0404 già ETAG 004. Realizzato con un contenuto di riciclato $\geq 10\%$. Disponibile anche in versione fugato sagomato (fughe decorative).</p> <p>Per sistema termok8: Grafite Plus Converto Formato: 100 x 50 cm Spessore: da 2 a 20 cm Resistenza a trazione: TR ≥ 100 kPa Classe reazione fuoco del sistema Termok8: B-s1,d0</p>	<p>unstressed EPS panel with the addition of graphite</p> <p>Unstressed insulation panel suitable for ETICS external thermal insulation systems, made of grey sintered expanded polystyrene. Approved according to EAD 040083-00-0404 (formerly ETAG 004). Made with $\geq 10\%$ recycled content. Also available in grooved versions (decorative groovings).</p> <p>For termok8 system: Grafite Plus Converto Size: 100 x 50 cm Thickness: from 2 to 20 cm Tensile strength: TR ≥ 100 kPa Termok8 system fire reaction class: B-s1,d0</p>	<p>panel en EPS con aditivo de grafito destensado</p> <p>Panel aislante destensado idóneo para la aplicación por capas SATE, realizado en poliestireno expandido sinterizado de color gris. Homologado según EAD 040083-00-0404, antes ETAG 004. Realizado con un contenido de reciclado $\geq 10\%$. Disponible también en versión perfilada (con ranuras decorativas).</p> <p>Para sistema termok8: Grafite Plus Converto Medidas: 100 x 50 cm Espesor: de 2 a 20 cm Resistencia a la tracción: TR ≥ 100 kPa Clase de reacción al fuego del sistema Termok8: B-s1,d0</p>
---	--	--	--

tecniche



certificazioni



converto fonostop



scheda
tecnica



data
sheet

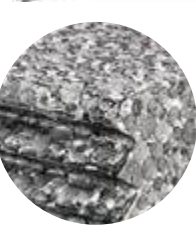

ficha
técnica

 	<p>pannello in EPS elasticizzato per un miglior isolamento acustico</p> <p>Pannello isolante elasticizzato ad elevata rigidità dinamica idoneo per l'applicazione a cappotto ETICS, realizzato in polistirene espanso sinterizzato di colore grigio con zigrinatura esterna profonda 6mm. Omologato secondo EAD 040083-00-0404 già ETAG 004. Realizzato con un contenuto di riciclato $\geq 10\%$.</p> <p>Per sistema Termok8: Fonostop Converto Formato: 100 x 50 cm Spessore: da 8 a 20 cm Resistenza a trazione TR ≥ 100 kPa Classe reazione fuoco del sistema Termok8: B-s1,d0</p>	<p>elastic EPS panel for better sound insulation</p> <p>Elastic insulating panel with high dynamic stiffness, suitable for ETICS external thermal insulation systems, made of grey sintered expanded polystyrene with 6mm-deep external grooved pattern. Approved according to EAD 040083-00-0404 (formerly ETAG 004). Made with $\geq 10\%$ recycled content.</p> <p>For Termok8 system: Fonostop Converto Size: 100 x 50 cm Thickness: from 8 to 20 cm Tensile strength: TR ≥ 100 kPa Termok8 system fire reaction class: B-s1,d0</p>	<p>panel en EPS elastizado para un mejor aislamiento acústico</p> <p>Panel aislante elastizado de elevada rigidez dinámica idóneo para la aplicación por capas SATE, realizado en poliestireno expandido sinterizado de color gris con moleteado externo de 6 mm de profundidad. Homologado según EAD 040083-00-0404, antes ETAG 004. Realizado con un contenido de reciclado $\geq 10\%$.</p> <p>Para sistema Termok8: Fonostop Converto Medidas: 100 x 50 cm Espesor: de 8 a 20 cm Resistencia a la tracción: TR ≥ 100 kPa Clase de reacción al fuego del sistema Termok8: B-s1,d0</p>
---	--	---	--

tecniche



certificazioni



converto HP











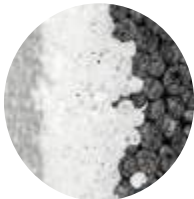

scheda
tecnica



data
sheet



ficha
técnica

	pannello in EPS sintolaminato	EPS panel produced by lamination synthesis	panel en EPS sintolaminado
 	<p>Pannello isolante sintolaminato idoneo per l'applicazione a cappotto ETICS, realizzato in polistirene espanso sinterizzato additivato con oltre il 70% di grafite e con strato esterno in EPS bianco per minimizzare gli effetti dell'irraggiamento. Omologato secondo EAD 040083-00-0404 già ETAG 004. Realizzato con un contenuto di riciclato $\geq 15\%$.</p> <p>Per sistema Termok8: HP Converto Formato: 120 x 60 cm Spessore: da 6 a 22 cm Resistenza a trazione TR ≥ 150 kPa Classe reazione fuoco del sistema Termok8: B-s1,d0</p>	<p>Insulating panel produced by lamination synthesis, suitable for ETICS external thermal insulation systems, made of sintered expanded polystyrene with the addition of over 70% graphite and with white EPS outer layer to minimise the effects of radiation. Approved according to EAD 040083-00-0404 (formerly ETAG 004). Made with $\geq 15\%$ recycled content.</p> <p>For Termok8 system: HP Converto Size: 120 x 60 cm Thickness: from 6 to 22 cm Tensile strength: TR ≥ 150 kPa Termok8 system fire reaction class: B-s1,d0</p>	<p>Panel aislante sintolaminado idóneo para la aplicación por capas SATE, realizado en poliestireno expandido sinterizado aditivado con más del 70 % de grafito y con capa externa de EPS blanco para reducir al mínimo los efectos de la radiación solar. Homologado según EAD 040083-00-0404, antes ETAG 004. Realizado con un contenido de reciclado $\geq 15\%$.</p> <p>Para sistema Termok8: HP Converto Medidas: 120 x 60 cm Espesor: de 6 a 22 cm Resistencia a la tracción: TR ≥ 150 kPa Clase de reacción al fuego del sistema Termok8: B-s1,d0</p>
tecniche	certificazioni		
    	   		

converto 35-100



scheda
tecnica



data
sheet



ficha
técnica

	pannello in EPS bianco	EPS panel - white	panel en EPS blanco
 	<p>Pannello isolante idoneo per l'applicazione a cappotto ETICS, realizzato in polistirene espanso sinterizzato di colore bianco. Omologato secondo EAD 040083-00-0404 già ETAG 004. Realizzato con un contenuto di riciclato $\geq 10\%$. Disponibile anche in versione fughato sagomato (fughe decorative).</p> <p>Per sistema Termok8: Classico Converto Formato: 100 x 50 cm Spessore: da 2 a 20 cm Resistenza a trazione: TR ≥ 150 kPa Resistenza a compressione CS(10) ≥ 100 kPa Classe reazione fuoco del sistema Termok8: B-s1,d0</p>	<p>Insulation panel suitable for ETICS external thermal insulation systems, made of white sintered expanded polystyrene. Approved according to EAD 040083-00-0404 (formerly ETAG 004). Made with $\geq 10\%$ recycled content. Also available in grooved versions (decorative groovings).</p> <p>For Termok8 system: Classico Converto Size: 100 x 50 cm Thickness: from 2 to 20 cm Tensile strength: TR ≥ 150 kPa Compressive strength: CS(10) ≥ 100 kPa Termok8 system fire reaction class: B-s1,d0</p>	<p>Panel aislante idóneo para la aplicación por capas SATE, realizado en poliestireno expandido sinterizado de color blanco. Homologado según EAD 040083-00-0404, antes ETAG 004. Realizado con un contenido de reciclado $\geq 10\%$. Disponible también en versión perfilada (con ranuras decorativas).</p> <p>Para sistema Termok8: Classico Converto Medidas: 100 x 50 cm Espesor: de 2 a 20 cm Resistencia a la tracción: TR ≥ 150 kPa Resistencia a la compresión CS(10) ≥ 100 kPa Clase de reacción al fuego del sistema Termok8: B-s1,d0</p>
tecniche	certificazioni		
     	   		

converto P 200



scheda
tecnica



data
sheet

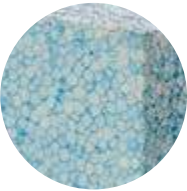

ficha
técnica

 	<p>pannello in EPS a basso assorbimento d'acqua</p>	<p>EPS panel with low water absorption</p>	<p>panel en EPS de baja absorción de agua</p>
	<p>Pannello isolante idoneo per l'applicazione a cappotto ETICS, realizzato in polistirene espanso sinterizzato di colore azzurro a basso assorbimento capillare d'acqua, per le zone perimetrali di zoccolatura. Omologato secondo EAD 040083-00-0404 già ETAG 004. Realizzato con un contenuto di riciclato $\geq 10\%$.</p>	<p>Insulation panel suitable for ETICS external thermal insulation systems, made of light blue sintered expanded polystyrene with low capillary water absorption, designed for building plinth areas. Approved according to EAD 040083-00-0404 (formerly ETAG 004). Made with $\geq 10\%$ recycled content.</p>	<p>Panel aislante idóneo para la aplicación por capas SATE, realizado en poliestireno expandido sinterizado de color celeste con baja absorción capilar de agua, para las zonas perimetrales de rodapié. Homologado según EAD 040083-00-0404, antes ETAG 004. Realizado con un contenido de reciclado $\geq 10\%$.</p>
<p>Per sistema Termok8: per le fasce di zoccolatura di tutti i sistemi Formato: 100 x 50 cm Spessore: da 4 a 20 cm Resistenza a trazione: TR ≥ 150 kPa Resistenza a compressione CS(10) ≥ 150 kPa Classe reazione fuoco del sistema Termok8: B-s1,d0</p>	<p>For Termok8 system: for the plinth areas of all systems Size: 100 x 50 cm Thickness: from 4 to 20 cm Tensile strength: TR ≥ 150 kPa Compressive strength: CS(10) ≥ 150 kPa Termok8 system fire reaction class: B-s1,d0</p>	<p>Para sistema Termok8: para las franjas de rodapié de todos los sistemas Medidas: 100 x 50 cm Espesor: de 4 a 20 cm Resistencia a la tracción: TR ≥ 150 kPa Resistencia a la compresión CS(10) ≥ 150 kPa Clase de reacción al fuego del sistema Termok8: B-s1,d0</p>	

tecniche



certificazioni



converto eps 30-g perimetro





scheda
tecnica



data
sheet



ficha
técnica

 	<p>pannello in EPS a basso assorbimento d'acqua</p>	<p>EPS panel with low water absorption</p>	<p>panel de EPS de baja absorción de agua</p>
	<p>Pannello isolante detensionato idoneo per l'applicazione a cappotto ETICS, re-alizzato in polistirene espanso sinterizzato di colore grigio a basso assorbimento capillare d'acqua, per le zone perimetrali di zoccolatura. Omologato secondo EAD 040083-00-0404 già ETAG 004. La lastra rispetta i Criteri Ambientali Minimi (CAM) attraverso l'impiego di EPS di riciclo, come disposto dal D.M. del 23 giugno 2022.</p>	<p>Insulating panel suitable for ETICS coat application, made of grey sintered expanded polystyrene with low capillary absorption, for the perimeter areas of skirting. Approved according to EAD 040083-00-0404 already ETAG 004. The slab complies with the Minimum Environmental Criteria (CAM) through the use of recycled EPS, as ordered by the D.M. of 23 June 2022.</p>	<p>Panel aislante retenido adecuado para la aplicación en capa SATE, re alizado en poliestireno expandido sinterizado de color gris con baja absorción capilar de aire, para las zonas perimetrales de zócalo. Homologado según EAD 040083-00-0404 ya ETAG 004. La placa cumple con los Criterios Ambientales Mínimos (CAM) mediante el uso de EPS de reciclaje, según lo dispuesto por el D.M. del 23 de junio de 2022.</p>
<p>Per sistema: Per le fasce di zoccolatura di tutti i sistemi Termok8 Formato: 100 x 50 cm Spessore: da 2 a 20 cm Classe di reazione fuoco della lastra: E Classe di reazione fuoco del sistema: B-s1,d0</p>	<p>For the system: For skirting strips of all Termok8 systems Size: 100 x 50 cm Thickness: from 2 to 20 cm Panel fire reaction class: E System fire reaction class: B-s1,d0</p>	<p>Para sistemas: Para las bandas de zócalo de todos los sistemas Termok8 Medidas: 100 x 50 cm Espesor: de 2 a 20 cm Clase de reacción al fuego del panel: E Clase de reacción al fuego del sistema: B-s1,d0</p>	

tecniche



certificazioni



converto 31 BW



scheda
tecnica



data
sheet



ficha
técnica

	<p>pannello in EPS additivato di grafite detensionato</p>	<p>unstressed EPS panel with the addition of graphite</p>	<p>panel en EPS con aditivo de grafito destensado</p>
	<p>Pannello isolante detensionato idoneo per l'applicazione a cappotto ETICS, realizzato in polistirene espanso sinterizzato di colore grigio/bianco. Omologato secondo EAD 040083-00-0404 già ETAG 004. Realizzato con un contenuto di riciclato $\geq 15\%$. Disponibile anche in versione fughato sagomato (fughe decorative).</p>	<p>Unstressed insulation panel suitable for ETICS external thermal insulation systems, made of grey/white sintered expanded polystyrene. Approved according to EAD 040083-00-0404 (formerly ETAG 004). Made with $\geq 15\%$ recycled content. Also available in grooved versions (decorative groovings).</p>	<p>Panel aislante destensado idóneo para la aplicación por capas SATE, realizado en poliestireno expandido sinterizado de color gris/blanco. Homologado según EAD 040083-00-0404, antes ETAG 004. Realizado con un contenido de reciclado $\geq 15\%$. Disponible también en versión perfilada (con ranuras decorativas).</p>
	<p>Per sistema Termok8: BW Converto Formato: 100 x 50 cm Spessore: da 2 a 20 cm Resistenza a trazione: TR ≥ 150 kPa Classe reazione fuoco del sistema Termok8: B-s1,d0</p>	<p>For Termok8 system: BW Converto Size: 100 x 50 cm Thickness: from 2 to 20 cm Tensile strength: TR ≥ 150 kPa Termok8 system fire reaction class: B-s1,d0</p>	<p>Para sistema Termok8: BW Converto Medidas: 100 x 50 cm Espesor: de 2 a 20 cm Resistencia a la tracción: TR ≥ 150 kPa Clase de reacción al fuego del sistema Termok8: B-s1,d0</p>

tecniche



certificazioni



converto 34 BW



scheda
tecnica



data
sheet



ficha
técnica

	<p>pannello in EPS additivato di grafite</p>	<p>EPS panel with the addition of graphite</p>	<p>panel en EPS con aditivo de grafito</p>
	<p>Pannello isolante detensionato idoneo per l'applicazione a cappotto ETICS, realizzato in polistirene espanso sinterizzato di colore bianco/grigio. Omologato secondo EAD 040083-00-0404 già ETAG 004. Realizzato con un contenuto di riciclato $\geq 10\%$. Disponibile anche in versione fughato sagomato (fughe decorative).</p>	<p>Unstressed insulation panel suitable for ETICS external thermal insulation systems, made of white/grey sintered expanded polystyrene. Approved according to EAD 040083-00-0404 (formerly ETAG 004). Made with $\geq 10\%$ recycled content. Also available in grooved versions (decorative groovings).</p>	<p>Panel aislante destensado idóneo para la aplicación por capas SATE, realizado en poliestireno expandido sinterizado de color blanco/gris. Homologado según EAD 040083-00-0404, antes ETAG 004. Realizado con un contenido de reciclado $\geq 10\%$. Disponible también en versión perfilada (con ranuras decorativas).</p>
	<p>Per sistema Termok8: BW Converto Formato: 100 x 50 cm Spessore: da 2 a 20 cm Resistenza a trazione: TR ≥ 100 kPa Classe reazione fuoco del sistema Termok8: B-s1,d0</p>	<p>For Termok8 system: BW Converto Size: 100 x 50 cm Thickness: from 2 to 20 cm Tensile strength: TR ≥ 100 kPa Termok8 system fire reaction class: B-s1,d0</p>	<p>Para sistema Termok8: BW Converto Medidas: 100 x 50 cm Espesor: de 2 a 20 cm Resistencia a la tracción: TR ≥ 100 kPa Clase de reacción al fuego del sistema Termok8: B-s1,d0</p>

tecniche



certificazioni



eps 35 max R













scheda
tecnica



data
sheet



ficha
técnica

 	<p>pannello in EPS per una maggiore resistenza agli urti</p>	<p>EPS panel for increased impact resistance</p>	<p>panel en EPS para una mayor resistencia a los golpes</p>
	<p>Pannello isolante detensionato idoneo per l'applicazione a cappotto ETICS, realizzato in polistirene espanso sinterizzato con zigrinatura esterna per migliorare la resistenza agli urti del sistema ≥ 20 J e 60 J. Omologato secondo EAD 040083-00-0404 già ETAG 004. Realizzato con un contenuto di riciclato $\geq 15\%$.</p> <p>Per sistemi Termok8: A.R. Max 20 J e A.R. Max 60 J Formato: 100 x 50 cm Spessore: da 4 a 20 cm Resistenza a trazione TR ≥ 150 kPa Classe reazione fuoco del sistema Termok8: B-s1,d0</p>	<p>Unstressed insulation panel suitable for ETICS external thermal insulation systems, made of sintered expanded polystyrene with external grooved pattern to improve system impact resistance ≥ 20 J and 60 J. Approved according to EAD 040083-00-0404 (formerly ETAG 004). Made with $\geq 15\%$ recycled content.</p> <p>For Termok8 systems: A.R. Max 20 J and A.R. Max 60 J Size: 100 x 50 cm Thickness: from 4 to 20 cm Tensile strength: TR ≥ 150 kPa Termok8 system fire reaction class: B-s1,d0</p>	<p>Panel aislante destensado idóneo para la aplicación por capas SATE, realizado en poliestireno expandido sinterizado, con moleteado externo para mejorar la resistencia a los golpes del sistema ≥ 20 J y 60 J. Homologado según EAD 040083-00-0404, antes ETAG 004. Realizado con un contenido de reciclado $\geq 15\%$.</p> <p>Para sistemas Termok8: A.R. Máx 20 J y A.R. Max 60 J Medidas: 100 x 50 cm Espesor: de 4 a 20 cm Resistencia a la tracción: TR ≥ 150 kPa Clase de reacción al fuego del sistema Termok8: B-s1,d0</p>
<p>tecniche</p>    		<p>certificazioni</p>    	

eps 35-100 fix R













scheda
tecnica



data
sheet



ficha
técnica

 	<p>pannello in EPS per sistemi modulari</p>	<p>EPS panel for modular systems</p>	<p>panel en EPS para sistemas modulares</p>
	<p>Pannello isolante idoneo per l'applicazione a cappotto ETICS, realizzato in polistirene espanso sinterizzato di colore bianco con zigrinatura su entrambi i lati e, sulla superficie esterna, quattro scassi trasversali ribassati. Realizzato con un contenuto di riciclato $\geq 10\%$.</p> <p>Per sistemi Termok8: Modular Design Formato: 100 x 50 cm Spessore: da 4 a 20 cm Resistenza a trazione TR ≥ 150 kPa Resistenza a compressione CS(10) ≥ 100 kPa Classe reazione fuoco del sistema Termok8: B-s1,d0</p>	<p>Insulation panel suitable for ETICS external thermal insulation systems, made of white sintered expanded polystyrene with grooved pattern on both sides and four deep transversal grooves on the external surface. Made with $\geq 10\%$ recycled content.</p> <p>For Termok8 systems: Modular Design Size: 100 x 50 cm Thickness: from 4 to 20 cm Tensile strength: TR ≥ 150 kPa Compressive strength: CS(10) ≥ 100 kPa Termok8 system fire reaction class: B-s1,d0</p>	<p>Panel aislante idóneo para la aplicación por capas SATE, realizado en poliestireno expandido sinterizado de color blanco con moleteado en los dos lados y cuatro cavidades transversales rebajadas en la superficie externa. Realizado con un contenido de reciclado $\geq 10\%$.</p> <p>Para sistemas Termok8: Modular Design Medidas: 100 x 50 cm Espesor: de 4 a 20 cm Resistencia a la tracción: TR ≥ 150 kPa Resistencia a la compresión CS(10) ≥ 100 kPa Clase de reacción al fuego del sistema Termok8: B-s1,d0</p>
<p>tecniche</p>    		<p>certificazioni</p>    	

eps meccanico R





scheda
tecnica



data
sheet



ficha
técnica

 	<p>pannello in EPS per supporti difficili</p> <p>Pannello isolante idoneo per l'applicazione a cappotto ETICS, realizzato in polistirene espanso sinterizzato di colore bianco, fresato lungo i quattro lati con un'opportuna scanalatura per il fissaggio dei profili del sistema meccanico. Realizzato con un contenuto di riciclato $\geq 15\%$</p>	<p>EPS panel for difficult substrates</p> <p>Insulation panel suitable for ETICS external thermal insulation systems, made of white sintered expanded polystyrene with grooves cut into all four sides to fasten the mechanical system profiles. Made with $\geq 15\%$ recycled content</p>	<p>panel en EPS para soportes difíciles</p> <p>Panel aislante idóneo para la aplicación por capas SATE, realizado en poliestireno expandido sinterizado de color blanco, fResidimentodo a lo largo de los cuatro lados con una ranura para la fijación de los perfiles del sistema mecánico. Realizado con un contenido de reciclado $\geq 15\%$</p>
	<p>Per sistema Termok8: Meccanico Formato: 60 x 60 cm Spessore: da 5 a 20 cm Resistenza a trazione TR ≥ 200 kPa Classe reazione fuoco del sistema Termok8: B-s2,d0</p>	<p>For Termok8 system: Meccanico Size: 60 x 60 cm Thickness: from 5 to 20 cm Tensile strength: TR ≥ 200 kPa Termok8 system fire reaction class: B-s2,d0</p>	<p>Para sistema Termok8: Meccanico Medidas: 60 x 60 cm Espesor: de 5 a 20 cm Resistencia a la tracción:TR ≥ 200 kPa Clase de reacción al fuego del sistema Termok8: B-s2,d0</p>

tecniche



certificazioni



eps 31-G max R



scheda
tecnica



data
sheet

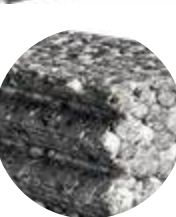

ficha
técnica

 	<p>pannello in EPS additivato di grafite</p> <p>Pannello isolante detensionato idoneo per l'applicazione a cappotto ETICS, realizzato in polistirene espanso sinterizzato di colore grigio con zigrinatura esterna per migliorare la resistenza agli urti del sistema ≥ 20 J e 60 J. Omologato secondo EAD 040083-00-0404 già ETAG 004. Realizzato con un contenuto di riciclato $\geq 15\%$.</p>	<p>EPS panel with the addition of graphite</p> <p>Unstressed insulation panel suitable for ETICS external thermal insulation systems, made of grey sintered expanded polystyrene with external grooved pattern to improve system impact resistance ≥ 20 J and 60 J. Approved according to EAD 040083-00-0404 (formerly ETAG 004). Made with $\geq 15\%$ recycled content.</p>	<p>panel en EPS con aditivo de grafito</p> <p>Panel aislante destensado idóneo para la aplicación por capas SATE, realizado en poliestireno expandido sinterizado de color gris con moleteado externo para mejorar la resistencia a los golpes del sistema ≥ 20 J y 60 J. Homologado según EAD 040083-00-0404 antes ETAG 004. Realizado con un contenido de reciclado $\geq 15\%$.</p>
	<p>Per sistemi Termok8: A.R. Max 20 J e A.R. Max 60 J Formato: 100 x 50 cm Spessore: da 4 a 20 cm Resistenza a trazione TR ≥ 120 kPa Classe reazione fuoco del sistema Termok8: B-s1,d0</p>	<p>For Termok8 systems: A.R. Max 20 J and A.R. Max 60 J Size: 100 x 50 cm Thickness: from 4 to 20 cm Tensile strength: TR ≥ 120 kPa Termok8 system fire reaction class: B-s1,d0</p>	<p>Para sistemas Termok8: A.R. Máx 20 J y A.R. Max 60 J Medidas: 100 x 50 cm Espesor: de 4 a 20 cm Resistencia a la tracción: TR ≥ 120 kPa Clase de reacción al fuego del sistema Termok8: B-s1,d0</p>

tecniche



certificazioni



eps 31-G 100 fix R



scheda
tecnica

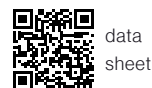

data
sheet



ficha
técnica

	<p>pannello in EPS additivato di grafite per sistemi modulari</p>	<p>unstressed EPS panel with the addition of graphite</p>	<p>panel en EPS con aditivo de grafito destensado</p>
	<p>Pannello isolante idoneo per l'applicazione a cappotto ETICS, realizzato in polistirene espanso sinterizzato di colore grigio con zigrinatura su entrambi i lati e, sulla superficie esterna, quattro scassi trasversali ribassati. Realizzato con un contenuto di riciclato $\geq 10\%$.</p>	<p>Insulation panel suitable for ETICS external thermal insulation systems, made of grey sintered expanded polystyrene with grooved pattern on both sides and four deep transversal grooves on the external surface. Made with $\geq 10\%$ recycled content.</p>	<p>Panel aislante idóneo para la aplicación por capas SATE, realizado en poliestireno expandido sinterizado de color gris con moleteado en los dos lados y cuatro cavidades transversales rebajadas en la superficie externa. Con contenido de reciclado $\geq 10\%$.</p>
	<p>Per sistemi Termok8: Modular Design Formato: 100 x 50 cm Spessore: da 4 a 20 cm Resistenza a trazione TR ≥ 150 kPa Resistenza a compressione CS(10) ≥ 100 kPa Classe reazione fuoco del sistema Termok8: B-s1,d0</p>	<p>For Termok8 systems: Modular Design Size: 100 x 50 cm Thickness: from 4 to 20 cm Tensile strength: TR ≥ 150 kPa Compressive strength: CS(10) ≥ 100 kPa Termok8 system fire reaction class: B-s1,d0</p>	<p>Para sistemas Termok8: Modular Design Medidas: 100 x 50 cm Espesor: de 4 a 20 cm Resistencia a la tracción: TR ≥ 150 kPa Resistencia a la compresión CS(10) ≥ 100 kPa Clase de reacción al fuego del sistema Termok8: B-s1,d0</p>

tecniche	certificazioni

eps G meccanico R

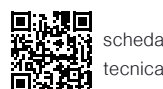

scheda
tecnica

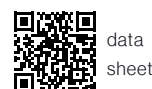

data
sheet



ficha
técnica

	<p>pannello in EPS additivato di grafite per supporti difficili</p>	<p>EPS panel with the addition of graphite for difficult substrates</p>	<p>panel en EPS con aditivo de grafite para soportes difíciles</p>
	<p>Pannello isolante idoneo per l'applicazione a cappotto ETICS, realizzato in polistirene espanso sinterizzato di colore grigio, fresato lungo i quattro lati con un'opportuna scanalatura per il fissaggio dei profili del sistema meccanico. Realizzato con un contenuto di riciclato $\geq 15\%$.</p>	<p>Insulation panel suitable for ETICS external thermal insulation systems, made of grey sintered expanded polystyrene with grooves cut into all four sides to fasten the profiles of the mechanical system. Made with $\geq 15\%$ recycled content.</p>	<p>Panel aislante idóneo para la aplicación por capas SATE, realizado en poliestireno expandido sinterizado de color gris, fRemdimientado a lo largo de los cuatro lados con una ranura para la fijación de los perfiles del sistema mecánico. Realizado con un contenido de reciclado $\geq 15\%$.</p>
	<p>Per sistema Termok8: Meccanico Formato: 60 x 60 cm Spessore: da 5 a 20 cm Resistenza a trazione TR ≥ 150 kPa Classe reazione fuoco del sistema Termok8: B-s2,d0</p>	<p>For Termok8 system: Meccanico Size: 60 x 60 cm Thickness: from 5 to 20 cm Tensile strength: TR ≥ 150 kPa Termok8 system fire reaction class: B-s2,d0</p>	<p>Para sistema Termok8: Meccanico Medidas: 60 x 60 cm Espesor: de 5 a 20 cm Resistencia a la tracción: TR ≥ 150 kPa Clase de reacción al fuego del sistema Termok8: B-s2,d0</p>

tecniche	certificazioni

eps 35 plus



scheda
tecnica



data
sheet



ficha
técnica



pannello in EPS bianco detensionato	unstressed EPS panel - white	panel en EPS blanco destensado
<p>Pannello isolante detensionato idoneo per l'applicazione a cappotto ETICS, realizzato in polistirene espanso sinterizzato di colore bianco. Omologato secondo EAD 040083-00-0404 già ETAG 004. Disponibile anche in versione fugato sagomato (fughe decorative)</p>	<p>Unstressed insulation panel suitable for ETICS external thermal insulation systems, made of white sintered expanded polystyrene. Approved according to EAD 040083-00-0404 (formerly ETAG 004). Also available in grooved versions (decorative groovings).</p>	<p>Panel aislante destensado idóneo para la aplicación por capas SATE, realizado en poliestireno expandido sinterizado de color blanco. Homologado según EAD 040083-00-0404, antes ETAG 004. Disponible también en versión para juntas perfiladas (juntas decorativas)</p>
<p>Per sistema Termok8: Classico 35 Plus Formato: 100 x 50 cm Spessore: da 2 a 20 cm Resistenza a trazione TR ≥ 150 kPa Classe reazione fuoco del sistema Termok8: B-s1,d0</p>	<p>For Termok8 system: Classico 35 Plus Size: 100 x 50 cm Thickness: from 2 to 20 cm Tensile strength: TR ≥ 150 kPa Termok8 system fire reaction class: B-s1,d0</p>	<p>Para sistema Termok8: Classico 35 Plus Medidas: 100 x 50 cm Espesor: de 2 a 20 cm Resistencia a la tracción: TR ≥ 150 kPa Clase de reacción al fuego del sistema Termok8: B-s1,d0</p>

tecniche	certificazioni

lana di roccia monodensità



scheda tecnica



data sheet



ficha técnica



pannello in lana di roccia monodensità

Pannello isolante in lana minerale di roccia (MW) idoneo per l'applicazione a capotto ETICS, biosolubile, incombustibile, con elevate prestazioni di isolamento termico, acustico e con elevata diffusività al vapore. Omologato secondo EAD 040083-00-0404 già ETAG 004. Fornibile su richiesta nella versione con primer ai silicati di calcio su un lato per facilitare la posa della rasatura. Su ordinazione sono disponibili pannelli con $\lambda = 0,034$ W/m-K e $\lambda = 0,035$ W/m-K

Per sistemi Termok8: Minerale L.R. e Modular Flex L.R.
Formato: 100 x 60 cm
Spessore: da 6 a 20 cm
Resistenza a trazione: TR \geq 7,5 kPa
Classe reazione fuoco del sistema Termok8: A2-s1,d0

single-density rock wool panel

Rock mineral wool insulation panel (MW) suitable for ETICS external thermal insulation systems. Biosoluble, non-combustible, provides high thermal and acoustic insulation performance and high vapour diffusivity. Approved according to EAD 040083-00-0404 (formerly ETAG 004). Upon request, can be supplied with calcium silicate primer on one side to facilitate application of the skim coat. Panels with $\lambda = 0.034$ W/m-K and $\lambda = 0.035$ W/m-K available upon request.

For Termok8 systems: Minerale L.R. and Modular Flex L.R.
Size: 100 x 60 cm
Thickness: from 6 to 20 cm
Tensile strength: TR \geq 7.5 kPa
Termok8 system fire reaction class: A2-s1,d0

panel en lana de roca monodensidad

Panel aislante en lana mineral de roca (MW) idóneo para la aplicación por capas SATE, biosoluble, incombustible, con altas prestaciones de aislamiento térmico, acústico y con gran capacidad de difusión del vapor. Homologado según EAD 040083-00-0404, antes ETAG 004. Bajo pedido puede suministrarse en la versión con imprimación de silicatos de calcio por un lado para facilitar la aplicación del enrasado. Bajo pedido hay disponibles paneles con $\lambda = 0,034$ W/m-K y $\lambda = 0,035$ W/m-K

Para sistemas Termok8: Minerale L.R. y Modular Flex L.R.
Medidas: 100 x 60 cm
Espesor: de 6 a 20 cm
Resistencia a la tracción: TR \geq 7,5 kPa
Clase de reacción al fuego del sistema Termok8: A2-s1,d0

tecniche



certificazioni



lana di roccia doppia densità



scheda tecnica



data sheet



ficha técnica



pannello in lana di roccia a doppia densità

Pannello isolante in lana minerale di roccia (MW) idoneo per l'applicazione a capotto ETICS, biosolubile, incombustibile, con elevate prestazioni di isolamento termico, acustico e con elevata diffusività al vapore. Omologato secondo EAD 040083-00-0404 già ETAG 004.

Per Termok8 sistemi: Minerale L.R. e Modular Flex L.R.
Formato: 120 x 60 cm
Spessore: da 6 a 20 cm
Resistenza a trazione: TR \geq 7,5 kPa
Classe reazione fuoco del sistema Termok8: A2-s1,d0

double-density rock wool panel

Mineral rock wool insulation panel (MW) suitable for ETICS external thermal insulation systems. Biosoluble, non-combustible, provides high thermal and acoustic insulation performance and high vapour diffusivity. Approved according to EAD 040083-00-0404 (formerly ETAG 004).

For Termok8 systems: Minerale L.R. and Modular Flex L.R.
Size: 120 x 60 cm
Thickness: from 6 to 20 cm
Tensile strength: TR \geq 7.5 kPa
Termok8 system fire reaction class: A2-s1,d0

panel en lana de roca de doble densidad

Panel aislante en lana mineral de roca (MW) idóneo para la aplicación por capas SATE, biosoluble, incombustible, con altas prestaciones de aislamiento térmico, acústico y con gran capacidad de difusión del vapor. Homologado según EAD 040083-00-0404, antes ETAG 004.

Para sistemas Termok8: Minerale L.R. y Modular Flex L.R.
Medidas: 120 x 60 cm
Espesor: de 6 a 20 cm
Resistencia a la tracción: TR \geq 7,5 kPa
Clase de reacción al fuego del sistema Termok8: A2-s1,d0

tecniche



certificazioni



lana di vetro k34



scheda
tecnica



data
sheet



ficha
técnica

	pannello in lana di vetro	glass fibre panel	panel en lana de vidrio
 	<p>Pannello isolante in lana minerale di vetro (MW) idoneo per l'applicazione a cappotto ETICS, biosolubile, incombustibile, con elevate prestazioni di isolamento termico, acustico e con elevata diffusività al vapore. Prodotto in Italia con almeno l'80% di vetro riciclato. Omologato secondo EAD 040083-00-0404 già ETAG 004.</p> <p>Per sistema Termok8: Minerale L.V. Formato: 120 x 60 cm Spessore: da 6 a 20 cm Resistenza a trazione: TR ≥ 7,5 kPa Classe reazione fuoco del sistema Termok8: A2-s1,d0</p>	<p>Mineral glass fibre insulation panel (MW) suitable for ETICS external thermal insulation systems. Biosoluble, non-combustible, provides high thermal and acoustic insulation performance and high vapour diffusivity. Made in Italy with at least 80% recycled glass. Approved according to EAD040083-00-0404 (formerly ETAG 004).</p> <p>For Termok8 system: Minerale L.V. Size: 120 x 60 cm Thickness: from 6 to 20 cm Tensile strength: TR ≥ 7,5 kPa Termok8 system fire reaction class: A2-s1,d0</p>	<p>Panel aislante en lana mineral de vidrio (MW) idóneo para la aplicación por capas SATE, biosoluble, incombustible, con altas prestaciones de aislamiento térmico, acústico y con gran capacidad de difusión del vapor. Producido en Italia con un mínimo del 80 % de vidrio reciclado. Homologado según EAD 040083-00-0404, antes ETAG 004.</p> <p>Para sistema Termok8: Minerale L.V. Medidas: 120 x 60 cm Espesor: de 6 a 20 cm Resistencia a la tracción: TR ≥ 7,5 kPa Clase de reacción al fuego del sistema Termok8: A2-s1,d0</p>

tecniche



certificazioni



multipor





scheda
tecnica



data
sheet



ficha
técnica

	pannello minerale	mineral panel	panel mineral
 	<p>Pannello isolante minerale idoneo per l'applicazione a cappotto ETICS, a base di idrati di silicato di calcio autoclavato, incombustibile e con elevata diffusività al vapore. Dotato di omologazione ETA 05/0093 secondo EAD 040012-00-1201.</p> <p>Per sistema Termok8: Minerale Eco Formato: 60 x 39 cm Spessore: da 6 a 14 cm Resistenza a trazione TR ≥ 80 kPa Resistenza a compressione CS(10) ≥ 300 kPa Classe reazione fuoco del pannello: A1</p>	<p>Mineral insulation panel suitable for ETICS external thermal insulation systems. Contains autoclaved calcium silicate hydrates, is non-combustible and provides high vapour diffusivity. ETA 05/0093-certified according to EAD 040012-00-1201.</p> <p>For Termok8 system: Minerale Eco Size: 60 x 39 cm Thickness: from 6 to 14 cm Tensile strength: TR ≥ 80 kPa Compressive strength: CS(10) ≥ 300 kPa Panel fire reaction class: A1</p>	<p>Panel aislante mineral idóneo para la aplicación por capas SATE, a base de hidratos de silicato de calcio autoclavado, incombustible y con gran capacidad de difusión del vapor. Homologado ETA 05/0093 según EAD 040012-00-1201.</p> <p>Para sistema Termok8: Minerale Eco Medidas: 60 x 39 cm Espesor: de 6 a 14 cm Resistencia a la tracción: TR ≥ 80 kPa Resistencia a la compresión CS(10) ≥ 300 kPa Clase de reacción al fuego del panel: A1</p>

tecniche



certificazioni



stiferite class SK



scheda tecnica



data sheet



ficha técnica

 	<p>pannello in poliuretano espanso rigido</p> <p>Pannello isolante in schiuma polyiso espansa (PIR), idoneo per l'applicazione a cappotto ETICS, con elevate prestazioni di isolamento termico, rivestito su entrambe le facce con velo vetro saturato. Omologato secondo EAD 040083-00-0404 già ETAG 004.</p> <p>Per sistema Termok8: Slim Formato: 120 x 60 cm Spessore: da 2 a 20 cm Resistenza a trazione TR ≥ 80 kPa Classe reazione fuoco del sistema Termok8: B-s1,d0</p>	<p>rigid polyurethane foam panel</p> <p>Polyiso foam insulation panel (PIR), suitable for ETICS external thermal insulation systems, with high thermal insulation performance, coated on both sides with a thin film of saturated glass. Approved according to EAD 040083-00-0404 (formerly ETAG 004).</p> <p>For Termok8 system: Slim Size: 120 x 60 cm Thickness: from 2 to 20 cm Tensile strength: TR ≥ 80 kPa Termok8 system fire reaction class: B-s1,d0</p>	<p>panel en poliuretano expandido rígido</p> <p>Panel aislante en espuma polyiso (PIR), idóneo para la aplicación por capas SATE, con altas prestaciones de aislamiento térmico, revestido por las dos caras con velo de vidrio saturado. Homologado según EAD 040083-00-0404, antes ETAG 004.</p> <p>Para sistema Termok8: Slim Medidas: 120 x 60 cm Espesor: de 2 a 20 cm Resistencia a la tracción: TR ≥ 80 kPa Clase de reacción al fuego del sistema Termok8: B-s1,d0</p>
---	---	--	---

tecniche



certificazioni



sughero ambrato





scheda tecnica



data sheet



ficha técnica

 	<p>pannello in sughero ambrato</p> <p>Pannello per isolamento termo-acustico realizzato in sughero espanso, autocollato, idoneo per l'applicazione a cappotto ETICS, totalmente naturale poiché ottenuto tramite processo termico di tostatura, quindi senza aggiunta di colle o di sostanze chimiche, certificato secondo UNI EN 13170. Certificato per la bioedilizia da Natureplus, ANAB ed ICEA.</p> <p>Per sistema Termok8: Sughero Formato: 100 x 50 cm Spessore: da 3 a 18 cm Densità: 110 kg/m³ Resistenza a compressione CS(10) ≥ 100 kPa</p>	<p>amber cork panel</p> <p>Thermal and acoustic insulation panel made of self-adhesive expanded cork, suitable for ETICS external thermal insulation systems. It is totally natural since it is obtained through a thermal toasting process which does not use glues or chemical substances. UNI EN 13170 certified. Certified for green housing by Natureplus, ANAB and ICEA.</p> <p>For Termok8 system: Sughero Size: 100 x 50 cm Thickness: from 3 to 18 cm Density: 110 kg/m³ Compressive strength: CS(10) ≥ 100 kPa</p>	<p>panel en corcho ámba</p> <p>Panel para aislamiento termo-acústico realizado en corcho expandido, autoencolado, idóneo para la aplicación por capas SATE, totalmente natural porque se obtiene mediante proceso térmico de tostado, es decir, sin añadido de colas o de sustancias químicas, certificado según UNI EN 13170. Certificado para eco-arquitectura por Natureplus, ANAB y ICEA.</p> <p>Para sistema Termok8: Sughero (corcho) Medidas: 100 x 50 cm Espesor: de 3 a 18 cm Densidad: 110 kg/m³ Resistencia a la compresión CS(10) ≥ 100 kPa</p>
---	--	--	---

tecniche



certificazioni



PH 20



scheda
tecnica



data
sheet



ficha
técnica

	<p>pannello in resina fenolica espansa rigida</p> <p>Pannello isolante in schiuma di resina fenolica espansa (PF), idoneo per l'applicazione a cappotto ETICS, con elevate prestazioni di isolamento termico, rivestito su entrambi i lati con velo vetro saturato. Omologato secondo UNI EN 13166.</p> <p>Per sistema Termok8: Fenolico Formato: 120 x 60 cm (per lastre da 2 e 3 cm dimensione lastra 120x120 cm) Spessore: da 2 a 16 cm Resistenza a trazione TR ≥ 80 kPa Classe reazione fuoco del sistema Termok8: B-s1,d0</p>	<p>rigid phenolic resin foam panel</p> <p>Phenolic resin foam (PF) insulation panel, suitable for ETICS external thermal insulation systems, with high thermal insulation performance, coated on both sides with a thin film of saturated glass. Approved according to UNI EN 13166.</p> <p>For Termok8 system: Fenolico Size: 120 x 60 cm (for 2 and 3 cm slabs measuring 120x120 cm) Thickness: from 2 to 16 cm Tensile strength: TR ≥ 80 kPa Termok8 system fire reaction class: B-s1,d0</p>	<p>panel en resina fenólica expandida rígida</p> <p>Panel aislante en espuma de resina fenólica expandida (PF), idóneo para la aplicación por capas SATE, con altas prestaciones de aislamiento térmico, revestido por las dos caras con velo de vidrio saturado. Homologado según UNI EN 13166.</p> <p>Para sistema Termok8: Fenólico Medidas: 120 x 60 cm (para placas de 2 y 3 cm medidas de la placa 120x120 cm) Espesor: de 2 a 16 cm Resistencia a la tracción: TR ≥ 80 kPa Clase de reacción al fuego del sistema Termok8: B-s1,d0</p>
--	--	--	--

<p>tecniche</p>  <p>Da 80 a 160 mm Da 20 a 70 mm</p>	<p>certificazioni</p> 
--	--

PH 20 king



scheda
tecnica



data
sheet



ficha
técnica

	<p>pannello in resina fenolica espansa rigida</p> <p>Pannello per isolamento termico realizzato in schiuma di resina fenolica espansa (PF), espansa senza l'impiego di CFC o HCFC e HFC, certificato ETICS secondo le linee guida ETAG 004:2013. Certificato in sistema 3 di Valutazione e Verifica della Costanza della Prestazione (VVCP) secondo UNI EN 13166:2016. Rivestito su entrambe le facce con velo vetro saturato.</p> <p>Per sistema Termok8: Fenolico Formato: 120 x 40 cm Spessore: da 2 a 16 cm Resistenza a trazione TR ≥ 80 kPa Classe reazione fuoco del sistema Termok8: C-s2,d0</p>	<p>rigid phenolic resin foam panel</p> <p>Expanded Phenolic resin foam (PF) insulation panel, expanded without the use of CFCs or HCFCs and HFCs, ETICS certified according to the ETAG 004: 2013 guidelines. Certified in system 3 of Evaluation and Verification of Constancy of Performance according to UNI EN 13166: 2016. Covered on both sides with saturated glass veil.</p> <p>For Termok8 system: Fenolico Size: 120 x 40 cm Thickness: from 2 to 16 cm Tensile strength: TR ≥ 80 kPa Termok8 system fire reaction class: C-s2,d0</p>	<p>panel en resina fenólica expandida rígida</p> <p>Panel aislante en espuma de resina fenólica expandida (PF) expandida sin el uso de CFC o HCFC y HFC, certificado SATE según la normativa ETAG 004: 2013. Certificado en el sistema 3 de Evaluación y Verificación de Constancia de Desempeño (VVCP) según UNI EN 13166: 2016. Revestido por ambos lados con velo de vidrio saturado.</p> <p>Para sistema Termok8: Fenolico Medidas: 120 x 40 cm Espesor: da 2 a 16 cm Resistencia a la tracción: TR ≥ 80 kPa Classe reazione fuoco del sistema Termok8: C-s2,d0</p>
--	---	--	--

<p>tecniche</p>  <p>Da 50 a 120 mm Da 20 a 40 mm</p>	<p>certificazioni</p> 
--	--

fibra di legno



scheda
tecnica



data
sheet



ficha
técnica

	pannello in EPS fibra di legno	Wood EPS fibreboard panel	panel en EPS fibra de madera
	<p>Pannello isolante in fibre legno monostrato pressate (WF) idoneo per l'applicazione a cappotto ETICS, intonacabile, rigido, idrofugo, con prestazioni di isolamento termico, acustico e con elevata diffusività al vapore. Omologato secondo UNI EN 13171. Certificato per la bioedilizia da Natureplus.</p>	<p>Single layer pressed wood fibreboard (WF) insulation panel suitable for ETICS external thermal insulation systems. Can be plastered over. It is stiff, waterproof and provides thermal and acoustic insulation and high vapour diffusivity. Approved according to UNI EN 13171. Certified for green housing by Natureplus.</p>	<p>Panel aislante en fibras de madera en una sola capa prensadas (WF) idóneo para la aplicación por capas SATE, admite enfoscado, rígido, hidrófugo, con prestaciones de aislamiento térmico, acústico y con gran capacidad de difusión del vapor. Homologado según UNI EN 13171. Certificado para eco-arquitectura por Natureplus.</p>
	<p>Per sistema Termok8: Wood Formato: 125 x 60 cm Spessore: da 6 a 20 cm Densità: 140 kg/m³ Resistenza a compressione CS(10) ≥ 100 kPa Resistenza a trazione TR ≥ 20 kPa</p>	<p>For Termok8 system: Wood Size: 125 x 60 cm Thickness: from 6 to 20 cm Density: 140 kg/m³ Compressive strength: CS(10) ≥ 100 kPa Tensile strength: TR ≥ 20 kPa</p>	<p>Para sistema Termok8: Wood Medidas: 125 x 60 cm Espesor: de 6 a 20 cm Densidad: 140 kg/m³ Resistencia a la compresión CS(10) ≥ 100 kPa Resistencia a la tracción: TR ≥ 20 kPa</p>
<p>tecniche</p>	<p>certificazioni</p>		

aeropan



scheda
tecnica



data
sheet



ficha
técnica

	pannello in EPS aerogel per l'isolamento dei ponti termici	EPS aerogel panel for insulation of thermal bridges	panel en EPS aerogel para aislamiento de puentes térmicos
	<p>Pannello isolante in aerogel, idoneo per l'isolamento di dettagli costruttivi di facciata quali imbotti, loggiati ed intradossi, con sorprendenti prestazioni di isolamento termico. Rivestito, sul lato esterno, con una membrana traspirante in polipropilene armato con fibra di vetro specifico per l'applicazione a cappotto ETICS.</p>	<p>Aerogel insulation panel, suitable for insulating façade construction details such as soffits, porticos and intrados, providing outstanding thermal insulation. Coated on the outside with a breathable, fibreglass-reinforced polypropylene membrane specifically designed for ETICS external thermal insulation systems.</p>	<p>Panel aislante en aerogel, idóneo para el aislamiento de detalles de construcción de fachada, como galerías porticadas y intradoses con sorprendentes prestaciones de aislamiento térmico. Revestido, por su lado exterior, con una membrana transpirante en polipropileno armado con fibra de vidrio, específico para la aplicación por capas SATE.</p>
	<p>Per isolamento di ponti termici Formato: 140 x 72 cm Spessore: da 1 a 6 cm</p>	<p>For the insulation of thermal bridges Size: 140 x 72 cm Thickness: from 1 to 6 cm</p>	<p>Para aislamiento de puentes térmicos Medidas: 140 x 72 cm Espesor: de 1 a 6 cm</p>
<p>tecniche</p>	<p>certificazioni</p>		

tassello H2

scheda
tecnicadata
sheetficha
técnica

tassello a percussione in HDPE e perno in acciaio zincato galvanizzato	HDPE percussion anchors and galvanised steel pin	taco de percusión en HDPE y perno de acero zincado galvanizado
Tassello universale a percussione con doppia zona di espansione (25/45mm) per calcestruzzo, laterizi pieni e forati, calcestruzzo alleggerito e calcestruzzo cellulare. Piattello telescopico, basculante, sottile e ad alta rigidità. Dotato di omologazione secondo EAD 330196-01-0604.	Universal percussion anchor with double expansion sleeve (25/45 mm) for concrete, solid and hollow brick, lightweight concrete and porous concrete. Telescoping, tilting, thin and highly stiff plate. Certified according to EAD 330196-01-0604.	Taco universal de percusión con doble zona de expansión (25/45 mm) para hormigón, ladrillos macizos y huecos, hormigón aligerado y hormigón celular. Plato telescópico, basculante, fino y de alta rigidez. Homologado según EAD 330196-01-0604.
Diametro stelo/foro: 8 mm Diametro piattello: 60 mm Profondità di foratura: 35 mm (55 mm cat. D, E) Profondità di ancoraggio: 25 mm (45 mm cat. D, E) Categorie d'utilizzo ETA: A, B, C, D, E	Shank/Bore Diameter: 8 mm Plate Diameter: 60 mm Drilling Depth: 35 mm (55 mm cat. D, E) Anchoring Depth: 25 mm (45 mm cat. D, E) ETA usage categories: A, B, C, D, E	Diámetro del vástago/agujero: 8 mm Diámetro del plato: 60 mm Profundidad de perforación: 35 mm (55 mm cat. D, E) Profundidad de anclaje: 25 mm (45 mm cat. D, E) Categorías de uso ETA: A, B, C, D, E

certificazioni



tassello CT 2G

scheda
tecnicadata
sheetficha
técnica

tassello ad avvitamento in HDPE vite in acciaio zincato e galvanizzato	HDPE screw anchor with galvanised steel screw	taco de rosca en HDPE con tornillo de acero zincado y galvanizado
Tassello universale ad avvitamento con zona di espansione in HDPE e vite in acciaio zincato galvanizzato per calcestruzzo, laterizi pieni e forati, calcestruzzo alleggerito e calcestruzzo cellulare per applicazioni a filo e ad incasso. Dotato di omologazione secondo EAD 330196-01-0604.	Universal screw anchor with HDPE expansion sleeve and galvanised steel screw designed for flush and recessed application in concrete, solid and hollow brick, lightweight concrete and porous concrete. Certified according to EAD 330196-01-0604.	Taco universal de rosca con zona de expansión en HDPE y tornillo de acero zincado y galvanizado para hormigón, ladrillos macizos y huecos, hormigón aligerado y hormigón celular para aplicaciones al ras y empotradas. Homologado según EAD 330196-01-0604.
Necessario per Termok8 Modulare e idonei per tutti gli altri Diametro stelo/foro: 8 mm Diametro piattello: 60 mm Profondità di ancoraggio: ≥ 25 mm Categorie d'utilizzo ETA: A, B, C, D, E Per montaggio a filo esterno utilizzare "tamponcino in EPS", per montaggio ad incasso utilizzare Copritassello in EPS/Lana di roccia.	For the Termok8 modular system and suitable for all other systems Shank/Bore Diameter: 8 mm Plate Diameter: 60 mm Anchoring depth: ≥ 25 mm ETA usage categories: A, B, C, D, E For flush surface mounting, use "tamponcino in EPS" plug, for recessed use "copritassello in EPS/LANA DI ROCCIA" cap,	Necesario para Termok8 Modular y idóneo para todos los demás sistemas Diámetro del vástago/agujero: 8 mm Diámetro del plato: 60 mm Profundidad de anclaje: ≥ 25 mm Categorías de uso ETA: A, B, C, D, E Para el montaje al ras exterior utilizar el tapón "tamponcino in EPS", para montaje empotrado utilizar el cubretaco "copritassello in EPS/Lana di Roccia"

certificazioni



tassello CT L



scheda
tecnica



data
sheet



ficha
técnica

	<p>tassello ad avvitamento con vite autofilettante in acciaio zincato galvanizzato</p> <p>Tassello universale ad avvitamento con vite autofilettante premontata in acciaio zincato galvanizzato per supporti in legno massiccio, OSB, truciolato e su sottostrutture in acciaio o alluminio fino a 0,75mm per applicazioni a filo e ad incasso.</p> <p>Per montaggio a filo esterno utilizzare "tamponcino in EPS" già compreso nella confezione, o per montaggio ad incasso "copritassello in EPS/Lana di Roccia" acquistabili separatamente. A richiesta "tappa" per pannello isolante.</p> <p>Diametro stelo/foro: 6 mm Diametro piattello: 60 mm Profondità di ancoraggio: 30-40 mm</p>	<p>HDPE screw anchor with self-tapping galvanised steel screw</p> <p>Universal screw anchor with pre-mounted, self-tapping galvanised steel screw for solid wood, OSB, chipboard and for flush and recessed application in steel or aluminium support structures of up to 0.75 mm thick.</p> <p>For flush surface mounting, use "tamponcino in EPS" plug included in the package or, for recessed mounting, use "copritassello in EPS/Lana di Roccia" cap, available separately. A circular drill bit for insulating panels is available upon request.</p> <p>Shank/Bore Diameter: 6 mm Plate Diameter: 60 mm Anchoring Depth: 30-40 mm</p>	<p>taco de rosca con tornillo autorroscante de acero zincado galvanizado</p> <p>Taco universal de rosca con tornillo autorroscante premontado de acero zincado galvanizado para soportes de madera maciza, OSB, aglomerado y sobre subestructuras de acero o aluminio hasta 0,75mm para aplicaciones al ras y empotradas. Para el montaje al ras exterior utilizar el tapón "tamponcino in EPS" ya incluido en el envase; para montaje empotrado utilizar cubretaco "copritassello in EPS/Lana di Roccia", que puede comprarse por separado. Bajo pedido, roseta de fijación para panel aislante.</p> <p>Diámetro del vástago/agujero: 6 mm Diámetro del plato: 60 mm Profundidad de anclaje: 30-40 mm</p>
--	--	--	---

certificazioni



tassello CT L A2



scheda
tecnica



data
sheet



ficha
técnica

	<p>tassello ad avvitamento con vite autofilettante anticorrosione</p> <p>Tassello universale ad avvitamento con vite autoforante premontata in acciaio inox anticorrosione per supporti in legno massiccio, OSB, truciolato e su sottostrutture in acciaio o alluminio per applicazioni a filo e ad incasso.</p> <p>Diametro stelo/foro: 6 mm Diametro piattello: 60 mm Profondità di ancoraggio: 30-40 mm</p>	<p>screw anchor for reduced thickness insulation</p> <p>Universal screw-on anchor with pre-assembled self-drilling screw in corrosion-resistant stainless steel for supports in solid wood, OSB, chipboard and on steel or aluminum substructures for flush and recessed applications.</p> <p>Rod / hole diameter: 6 mm Plate diameter: 60 mm Anchoring depth: 30-40 mm</p>	<p>taco de rosca para bajos espesores de aislante</p> <p>Anclaje atornillable universal con tornillo autotaladrante premontado de acero inoxidable resistente a la corrosión para soportes de madera maciza, OSB, aglomerado y sobre subestructuras de acero o aluminio para aplicaciones enrasadas y empotradas.</p> <p>Diámetro de varilla/agujero: 6 mm Diámetro de la placa: 60 mm Profundidad de anclaje: 30-40 mm</p>
--	---	--	--

certificazioni







tassello ad avvitamento per spessori di isolante ridotti	screw anchor with corrosion-resistant, self-tapping screw	taco de rosca con tornillo autorroscante anticorrosión
Tassello ad avvitamento con vite in materiale sintetico, specifico per spessori di isolante ridotti tipo AEROGEL o similari, idoneo per calcestruzzo, laterizi pieni e forati, calcestruzzo alleggerito e calcestruzzo cellulare per applicazioni a filo. Montaggio consentito per spessori di isolamento ≥ 20 mm. Dotato di omologazione secondo EAD 330196-01-0604.	Screwed anchor with screw in synthetic material, specific for reduced thicknesses of insulation such as AIRGEL or similar, suitable for concrete, solid and perforated bricks, lightened concrete and cellular concrete for flush applications. Assembly permitted for insulation thicknesses ≥ 20 mm. Equipped with approval according to EAD 330196-01-0604.	Anclaje atornillado con tornillo en material sintético, específico para espesores reducidos de aislamiento tipo AIRGEL o similar, apto para hormigón, ladrillo macizo y perforado, hormigón aligerado y hormigón celular para aplicaciones enrasadas. Montaje permitido para espesores de aislamiento ≥ 20 mm. Equipado con homologación según EAD 330196-01-0604.
Diametro stelo/foro: 8 mm Diametro piattello: 60 mm Profondità di ancoraggio: ≥ 30 mm. categorie d'applicazione A B C D Profondità di ancoraggio: ≥ 50 mm. categorie d'applicazione E Categorie d'utilizzo ETA: A, B, C D, E	Rod / hole diameter: 8 mm Plate diameter: 60 mm Anchoring depth: ≥ 30 mm. application categories A B C D Anchoring depth: ≥ 50 mm. application categories E ETA use categories: A, B, C D, E	Diámetro de varilla/agujero: 8 mm Diámetro de la placa: 60 mm Profundidad de anclaje: ≥ 30 mm. categorías de aplicación A B C D Profundidad de anclaje: ≥ 50 mm. categorías de aplicación E Categorías de uso ETA: A, B, C D, E

certificazioni





tassello H3

scheda
tecnicadata
sheetficha
técnica

	tassello a percussione in hdpe	hdpe percussion anchor	taco de percusión en hdpe
	Tassello universale a percussione con zona di espansione in HDPE per cls, laterizio pieno e forato con perno di espansione in PAGF 50 premontato. Piattello telescopico, basculante, sottile e ad alta rigidità. Dotato di omologazione secondo EAD 330196-01-0604.	Universal percussion anchor with HDPE expansion sleeve for concrete, solid brick and hollow brick with pre-installed PAGF 50 expansion pin. Telescoping, tilting, thin and highly stiff plate. Certified according to EAD 330196-01-0604.	Taco universal de percusión con zona de expansión en HDPE para hormigón, ladrillos macizos y ladrillos huecos con perno de expansión en PAGF 50 premontado. lato telescópico, basculante, fino y de alta rigidez. Homologado según EAD 330196-01-0604.
	Diametro stelo: 8 mm Diametro piattello: 60 mm Profondità di ancoraggio: ≥ 25 mm Categorie d'utilizzo ETA: A, B, C	Shank Diameter: 8 mm Plate Diameter: 60 mm Anchoring depth ≥ 25 mm ETA usage categories: A, B, C	Diámetro del vástago: 8 mm Diámetro del plato: 60 mm Profundidad de anclaje: ≥ 25 mm Categorías de uso ETA: A, B, C
certificazioni	  		

tassello SDK U

scheda
tecnicadata
sheetficha
técnica



	tassello ad avvitamento per guide Termok8 meccanico o profili di partenza	screw anchor For the Termok8: mechanical system guides or base profiles	taco de rosca para guías Termok8 mecánico o perfiles iniciales
	Tassello ad avvitamento (senza piattello) con vite autofilettante premontata in acciaio zincato galvanizzato per il fissaggio di guide orizzontali di sistemi a cappotto ad ancoraggio di tipo meccanico e di profili di partenza su calcestruzzo, laterizi pieni e forati, calcestruzzo alleggerito e calcestruzzo cellulare. Dotato di Certificazione EAD 330196-01-0604	Screw anchor (without plate) with pre-mounted self-tapping screw of galvanised steel for fastening horizontal system guides for mechanically anchored external thermal insulation systems and base profiles on concrete, solid and hollow brick, lightweight concrete and porous concrete. EAD 330196-01-0604 certified	Taco de rosca (sin plato) con tornillo autorroscante premontado de acero zincado galvanizado para la fijación de guías horizontales de sistemas por capas con anclaje de tipo mecánico, así como para perfiles iniciales sobre hormigón, ladrillos macizos y huecos, hormigón aligerado y hormigón celular. Dotado de Certificación EAD 330196-01-0604
	Diametro stelo/foro: 8 mm Profondità di ancoraggio: ≥ 25 mm. categorie d'applicazione A B C D Profondità di ancoraggio: ≥ 65 mm. categorie d'applicazione E Categorie d'utilizzo ETA: A, B, C, D, E	Shank/Bore Diameter: 8 mm Anchoring depth ≥ 25 mm. Application categories: A B C D Anchoring depth ≥ 65 mm. Application categories: E ETA usage categories: A, B, C, D, E	Diámetro del vástago/agujero: 8 mm Profundidad de anclaje: ≥ 25 mm, categorías de aplicación: A B C D Profundidad de anclaje: ≥ 65 mm, categoría de aplicación: E Categorías de uso ETA: A, B, C, D, E
certificazioni	 		

tassello ND K



scheda
tecnicadata
sheetficha
técnica

	tassello a percussione per profili di partenza	percussion anchor for base profiles	taco de percusión para perfiles iniciales
	Tassello a percussione e ad avvitamento senza piattello per il fissaggio di profili di partenza di sistemi a cappotto ETICS, con vite in acciaio zincato.	Percussion and screw anchor without plate for fastening base profiles of ETICS external thermal insulation systems, with galvanised steel screw.	Taco de percusión y de rosca sin plato para la fijación de perfiles iniciales de sistemas por capas SATE, con tornillo de acero zincado.
	Dimensioni: 6 mm, L=60 mm - 8 mm, L=80 mm Profondità di ancoraggio: ≤30 mm	Size: 6 mm, L =60 mm - 8 mm, L=80 mm Anchoring depth ≤30 mm	Medidas: 6 mm, L=60 mm - 8 mm, L=80 mm Profundidad de anclaje: ≤30 mm



piattello per lana di roccia VT 2G

	<p>piattello aggiuntiva in caso di montaggio ad incasso su lana minerale</p> <p>Piattello utile per ampliare la dimensione del piattello dei tasselli CT 2G , CT L e CT L A2 in caso di applicazione ad incasso su lana minerale a bassa densità o a doppia densità.</p>	<p>additional washer for recessed mounting on mineral wool</p> <p>Washer used to extend dimensions of CT 2G, CT L and CT L A2 anchor plates for recessed application on low-density or double density mineral wool.</p>	<p>arandela adicional en caso de montaje empotrado sobre lana mineral</p> <p>Arandela útil para ampliar el tamaño del plato de los tacos CT 2G , CT L y CT L A2 en caso de aplicación empotrada sobre lana mineral de baja densidad o doble densidad.</p>
<p>certificazioni</p>			
			

piattello per lana di roccia 90 mm

	<p>piattello aggiuntiva in caso di montaggio a filo su lana minerale</p> <p>Piattello utile per ampliare la dimensione del piattello dei tasselli CT 2G , CT L e CT L A2 ad un'ampiezza di mm 90 in caso di applicazione a filo su lana minerale a bassa densità.</p>	<p>additional washer for flush mounting on mineral wool</p> <p>Washer used to extend dimensions of CT 2G, CT L and CT L A2 anchor plates to a width of 90 mm for application on low-density mineral wool.</p>	<p>arandela adicional en caso de montaje al ras sobre lana mineral</p> <p>Arandela útil para ampliar el tamaño del plato de los tacos CT 2G , CT L y CT L A2 hasta un ancho de 90 mm en caso de aplicación al ras sobre lana mineral de baja densidad.</p>
<p>Dimensioni Ø 90 mm</p>		<p>Size: Ø 90 mm</p>	<p>Medidas Ø 90 mm</p>
<p>certificazioni</p>			
			

piattello per lana di roccia 140 mm

	<p>piattello aggiuntivo in caso di montaggio a filo su lana minerale</p> <p>Piattello utile per ampliare la dimensione del piattello dei tasselli CT 2G , CT L e CT L A2 ad un'ampiezza di mm 140 in caso di applicazione a filo su lana di roccia laminare.</p>	<p>additional washer for flush mounting on mineral wool</p> <p>Washer used to extend dimensions of CT 2G, CT L and CT L A2 anchor plates to a width of 140 mm for flush application on laminated rock wool.</p>	<p>arandela adicional en caso de montaje al ras sobre lana mineral</p> <p>Arandela útil para ampliar el tamaño del plato de los tacos CT 2G , CT L y CT L A2 hasta un ancho de 90 mm en caso de aplicación al ras sobre lana de roca laminar.</p>
<p>Dimensioni Ø 140 mm</p>		<p>Size: Ø 140 mm</p>	<p>Medidas Ø 140 mm</p>
<p>certificazioni</p>			
			

tappo in EPS per tassello CT 2G - CT L



cilindretti per tasselli CT 2G per montaggio a filo	cylinders for CT 2G anchors -flush mounting	cilindros para montaje de tacos CT 2G
tamponcino di chiusura in polistirolo (EPS) da abbinare ai tasselli CT 2G in caso di montaggio a filo del tassello sul pannello.	polystyrene (EPS) closure pad for use with CT 2G, CT L anchors for flush mounting the anchor on the panel.	tapón de cierre en poliestireno (EPS) para tacos CT 2G, CT L en caso de montaje al ras del taco en el panel.
Dimensioni: L= 14,9 mm	Size L= 14.9 mm	Medidas: L= 14,9 mm

copritassello



tappo in eps per applicazioni a incasso	eps plug for recessed applications	tapón en eps para aplicaciones empotradas
Tappi di chiusura utilizzati in abbinamento ai tasselli CT 2G, CT L e CT L A2 in caso di montaggio ad incasso.	Plugs for use with CT 2G, CT L and CT L A2 anchors for recessed mounting.	Tapones de cierre utilizados con los tacos CT 2G, CT L y CT L A2 en caso de montaje empotrado.
Diametro: mm 60.	Diameter: 60 mm.	Diámetro: 60 mm.

spalletta isolante per imbotte lai-sys eps



	<p>spalletta isolante prerasata in eps</p> <p>Spalletta prefinita LAI-SYS per l'isolamento della spalletta nell'imbotte della finestra. Trattasi di un EPS bianco già rasato con finitura cementizia e paraspigolo già integrato.</p> <p>Conducibilità termica: $\lambda = 0,035 \text{ W/mK}$ Spessore: 14 mm Profondità: 400 mm Lunghezze disponibili: 1,35 - 1,6 - 2 - 2,5 m N.B. su richiesta anche larghezza 155/195/235/300</p>	<p>preskimmed eps insulation reveal</p> <p>Prefinished LAI-SYS reveal for insulation of window intrados reveals. White, preskimmed EPS with cement-based finish and built-in corner bead.</p> <p>Thermal conductivity: $\lambda = 0.035 \text{ W/mK}$ Thickness: 14 mm Depth: 400 mm Available lengths: 1,35 - 1,6 - 2 - 2,5 m Note: upon request, widths of 155/195/235/300</p>	<p>jamba aislante pre-enrasada en eps</p> <p>Jamba con acabado previo LAI-SYS para el aislamiento de la jamba en el intradós de la ventana. Se trata de un material EPS blanco ya enrasado con acabado de cemento y protector de aristas ya integrado.</p> <p>Conductividad térmica: $\lambda = 0,035 \text{ W/mK}$ Espesor: 14 mm Profundidad: 400 mm Largoes disponibles: 1,35 - 1,6 - 2 - 2,5 m Nota: bajo pedido, también anchos 155/195/235/300</p>
--	---	--	--

spalletta isolante per imbotte lai-sys pu

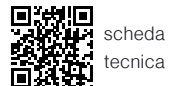

	<p>spalletta isolante prerasata in poliuretano</p> <p>Spalletta prefinita LAI-SYS per l'isolamento della spalletta nell'imbotte della finestra. Trattasi di un poliuretano già rasato con finitura cementizia e paraspigolo già integrato.</p> <p>Conducibilità termica: $\lambda = 0,029 \text{ W/mK}$ Spessore: 24 mm Profondità: 400 mm Lunghezze disponibili: 1,35 - 1,6 - 2 - 2,5 m N.B. su richiesta anche larghezza 155/195/235/300</p>	<p>preskimmed polyurethane insulation reveal</p> <p>Prefinished LAI-SYS reveal for insulation of window intrados reveals. Preskimmed polyurethane reveal with cement-based finish and built-in corner bead.</p> <p>Thermal conductivity: $\lambda = 0.029 \text{ W/mK}$ Thickness: 24 mm Depth: 400 mm Available lengths: 1,35 - 1,6 - 2 - 2,5 m Note: upon request, widths of 155/195/235/300</p>	<p>jamba aislante pre-enrasada en poliuretano</p> <p>Jamba con acabado previo LAI-SYS para el aislamiento de la jamba en el intradós de la ventana. Se trata de un poliuretano ya enrasado con acabado de cemento y protector de aristas ya integrado.</p> <p>Conductividad térmica: $\lambda = 0,029 \text{ W/mK}$ Espesor: 24 mm Profundidad: 400 mm Largoes disponibles: 1,35 - 1,6 - 2 - 2,5 m Nota: bajo pedido, también anchos 155/195/235/300</p>
--	--	--	--

spalletta isolante per imbotte lai-sys mw



	<p>spalletta isolante prerasata in lana di roccia</p> <p>Spalletta prefinita LAI-SYS per l'isolamento della spalletta nell'imbotte della finestra. Trattasi di lana di roccia già rasata con finitura cementizia e paraspigolo già integrato.</p> <p>Conducibilità termica: $\lambda = 0,037 \text{ W/mK}$ Spessore: 24 mm Profondità: 400 mm Lunghezze disponibili: 1350 - 1600 - 2000 - 2500 mm N.B. su richiesta anche larghezza 155/195/235/300</p>	<p>preskimmed rock wool insulation reveal</p> <p>Prefinished LAI-SYS reveal for insulation of window intrados reveals. Preskimmed rock wool reveal with cement-based finish and built-in corner bead.</p> <p>Thermal conductivity: $\lambda = 0.037 \text{ W/mK}$ Thickness: 24 mm Depth: 400 mm Available lengths: 1350 - 1600 - 2000 - 2500 mm Note: upon request, widths of 155/195/235/300</p>	<p>jamba aislante pre-enrasada en lana de roca</p> <p>Jamba con acabado previo LAI-SYS para el aislamiento de la jamba en el intradós de la ventana. Se trata de lana de roca ya enrasada con acabado de cemento y protector de aristas ya integrado.</p> <p>Conductividad térmica: $\lambda = 0,037 \text{ W/mK}$ Espesor: 24 mm Profundidad: 400 mm Largoes disponibles: 1350 - 1600 - 2000 - 2500 mm Nota: bajo pedido, también anchos 155/195/235/300</p>
--	---	--	---

profilo di connessione TYP U



scheda
tecnica



profilo di raccordo spalletta tapparella	reveal-roller shutter connection profile	perfil de conexión jamba-persiana
<p>Profilo di connessione in alluminio per la protezione della spalletta LAI-SYS in presenza di tapparelle scorrevoli. Da fissare meccanicamente nell'imbotte finestra. Consente di creare una zona portante dove far arrivare in battuta la spalletta Lai-Sys e, al contempo, proteggerla dagli urti meccanici dovuti alla movimentazione della tapparella.</p>	<p>Aluminium connection profile to protect the LAI-SYS reveal when roller shutters are used. To be mechanically fastened to the window intrados. Makes it possible to create a load-bearing area used for flush contact with the Lai-Sys reveal and, at the same time, serves to protect it from the mechanical impacts of shutter movement.</p>	<p>Perfil de conexión en aluminio para la protección de la jamba LAI-SYS en presencia de persianas deslizantes. Para fijar mecánicamente en el intradós de la ventana. Permite crear una zona portante en la que puede hacer tope la jamba Lai-Sys para, además, protegerla de los golpes mecánicos debidos al movimiento de la persiana.</p>
<p>Dimensione: sp.14 x 2500 mm sp.24 x 2500 mm</p>	<p>Size: th. 14 x 2500 mm th. 24 x 2500 mm</p>	<p>Medidas: esp.14 x 2500 mm esp. 24 x 2500 mm</p>

profilo di connessione PVC U-AL



scheda
tecnica



profilo di raccordo spalletta-tapparella	reveal-roller shutter connection profile	perfil de conexión jamba-persiana
<p>Profilo di connessione in PVC per la protezione della spalletta LAI-SYS contro serramento o contro il binario a vista della tapparella. Munito di aletta removibile, autoadesivo e verniciabile. Certificato per la tenuta all'aria e all'acqua.</p>	<p>PVC connection profile to protect the LAI-SYS reveal from the roller shutter frame or its visible track. Equipped with removable, self-adhesive and paintable flap. Certified for air and water tightness.</p>	<p>Perfil de conexión en PVC para la protección de la jamba LAI-SYS contra el cierre o contra el riel a la vista de la persiana. Dotado de aleta extraíble, autoadhesivo, admite recubrimiento de pintura. Certificado para el sellado de protección frente al aire y el agua.</p>
<p>Dimensione: sp.14 x 1350 - 1600 - 2000 mm sp.24 x 1600 mm</p>	<p>Size: th. 14 x 1350 - 1600 - 2000 mm th. 24 x 1600 mm</p>	<p>Medidas: esp.14 x 1350 - 1600 - 2000 mm esp. 24 x 1600 mm</p>

profilo orizzontale OR/LT



scheda
tecnica



profili di ancoraggio orizzontali per cappotto meccanico	horizontal anchor profiles for mechanical external thermal insulation system	perfiles de anclaje horizontales para sistema de aislamiento térmico mecánico
<p>Profilo estruso in lega d'alluminio per il fissaggio orizzontale del sistema Termok8 Meccanico atto a sostenere i pannelli EPS Meccanico R ed EPS G Meccanico R appositamente realizzati con scanalature ad incastro. Da fissare meccanicamente mediante tasselli SDK U.</p>	<p>Extruded aluminium alloy profile for horizontal fastening the Termok8 mechanical system to support the specially designed EPS Meccanico R and EPS G Meccanico R panels with interlocking grooves. To be mechanically fastened using SDK U anchors.</p>	<p>Perfil extruido en aleación de aluminio para la fijación horizontal del sistema Termok8 Mecánico, que permite sostener los paneles EPS Meccanico R y EPS G Meccanico R expresamente realizados con ranuras de encaje. Para fijar mecánicamente mediante tacos SDK U.</p>
<p>Incidenza: 1,7 m/m² Lunghezza barre: 6 m</p>	<p>Incidence: 1.7 m/m² Bar Length: 6 m</p>	<p>Incidencia: 1,7 m/m² Largo de las barras: 6 m</p>

profilo orizzontale PVC OR/LT



scheda
tecnica



profili di ancoraggio orizzontali per cappotto meccanico	horizontal anchor profiles for mechanical external thermal insulation system	perfiles de anclaje horizontales para sistema de aislamiento térmico mecánico
<p>Profilo in PVC per il fissaggio orizzontale del sistema Termok8 Meccanico atto a sostenere i pannelli EPS Meccanico R ed EPS G Meccanico R appositamente realizzati con scanalature ad incastro. Da fissare meccanicamente mediante tasselli SDK U.</p>	<p>PVC profile for horizontal fastening the Termok8 mechanical system to support the specially designed EPS Meccanico R and EPS G Meccanico R panels with interlocking grooves. To be mechanically fastened using SDK U anchors.</p>	<p>Perfil en PVC para la fijación horizontal del sistema Termok8 Mecánico, que permite sostener los paneles EPS Meccanico R y EPS G Meccanico R, expresamente realizados con ranuras de encaje. Para fijar mecánicamente mediante tacos SDK U.</p>
<p>Per sistema Termok8: Meccanico Lunghezza: 2,5 m Confezione: 20 pezzi = 50 m</p>	<p>For Termok8 system: Meccanico (mechanical) Length: 2.5 m Package: 20 pezzi = 50 m</p>	<p>Para sistema Termok8: Meccanico (mecánico) Largo: 2,5 m Envase: 20 piezas = 50 m</p>

profilo verticale VR/LT



scheda
tecnica



elementi di collegamento verticali per cappotto meccanico	vertical connection elements for mechanical external thermal insulation system	elementos de conexión verticales para sistema de aislamiento térmico mecánico
<p>Profilo estruso in lega d'alluminio per il fissaggio verticale del sistema Termok8 Meccanico atto a connettere i pannelli EPS Meccanico R ed EPS G Meccanico R appositamente realizzati con scanalature ad incastro.</p>	<p>Extruded aluminium alloy profile for vertical fastening of the Termok8 mechanical system to connect the specially designed EPS Meccanico R and EPS G Meccanico R panels with interlocking grooves.</p>	<p>Perfil extruido en aleación de aluminio para la fijación vertical del sistema Termok8 Mecánico, que permite sostener los paneles EPS Meccanico R y EPS G Meccanico R, expresamente realizados con ranuras de encaje.</p>
<p>Per sistema Termok8: Meccanico Incidenza: 1,6 m/m² Lunghezza barre: 6 m</p>	<p>For Termok8 system: Mechanical Incidence: 1.6 m/m² Bar Length: 6 m</p>	<p>Para sistema Termok8: Mecánico Incidencia: 1,6 m/m² Largo de las barras: 6 m</p>

profilo verticale PVC VR/LT



scheda
tecnica



elementi di collegamento verticali per cappotto meccanico	vertical connection elements for mechanical external thermal insulation system	Hidroes elementos de conexión verticales para sistema de aislamiento térmico mecánico malte
<p>Profilo in PVC per il fissaggio verticale del sistema Termok8 Meccanico atto a connettere i pannelli EPS Meccanico R ed EPS G Meccanico R appositamente realizzati con scanalature ad incastro.</p>	<p>PVC profile for vertical fastening of the Termok8 mechanical system to connect the specially designed EPS Meccanico R and EPS G Meccanico R panels with interlocking grooves.</p>	<p>Perfil en PVC para la fijación vertical del sistema Termok8 Mecánico, que permite sostener los paneles EPS Meccanico R y EPS G Meccanico R expresamente realizados con ranuras de encaje.</p>
<p>Per sistema Termok8: Meccanico Lunghezza: 47 cm Confezione: 100 pezzi = 47 m</p>	<p>For Termok8 system: Mechanical Length: 47 cm Package: 100 pezzi = 47 m</p>	<p>Para sistema: Termok8 Mecánico Largo: 47 cm Envase: 100 piezas = 47 m</p>

profilo di base



profilo di partenza in alluminio	base profile in aluminium	perfil inicial en aluminio
<p>Profilo di partenza ad U in alluminio naturale antialcalino o alluminio preverniciato, con gocciolatoio, per l'allineamento di partenza, la protezione ed il contenimento del sistema. Si consiglia l'uso del profilo "Rompigoccia per base di partenza" per evitare il rischio di cavillature nell'area della zoccolatura. Adatto a tutti i sistemi di isolamento termico.</p>	<p>U-shaped base profile in natural, anti-alkaline or pre-painted aluminium, with drip profile, for setting-out, protection and retention of the system. We recommend using the "Drip edge for base profile" profile to prevent the risk of cracking in the area around the building plinth. Suitable for all z thermal insulation systems.</p>	<p>Perfil inicial en U en aluminio natural antialcalino o aluminio prepintado, con gotero, para la alineación inicial, la protección y la contención del sistema. Se aconseja el uso del perfil "Rompegotas para base inicial" para evitar el riesgo de cuarteados en el área del rodapié. Idóneo para todos los sistemas de aislamiento térmico IVAS.</p>
<p>Per isolanti di spessore: da 3, a 16 cm (altri su richiesta) Lunghezza barre: 2,5 m Confezione: da 10 barre (tot 25 m)</p>	<p>For insulation thicknesses: from 3 to 16 cm (others available upon request) Bar Length: 2.5 m Package: 10 bars (total: 25 m)</p>	<p>Para aislantes de espesor: de 3 hasta 16 cm (otros bajo pedido) Largo de las barras: 2,5 m Envase: de 10 barras (tot 25 m)</p>

profilo di base PVC-R



scheda tecnica



profilo di partenza in pvc con elemento di chiusura	pvc base profile with closing element	perfil inicial en pvc con elemento de cierre
<p>Profilo di partenza ad L in pvc a taglio termico abbinato con un raccordo di chiusura variabile, provvisto di gocciolatoio, rete di risvolto ed elemento di connessione per ridurre il pericolo di cavillature nell'area della zoccolatura. Il profilo ad L di partenza, viene fornito in due misure per poter coprire isolamenti di spessore variabile da 10 a 24 cm. Adatto a tutti i sistemi di isolamento termico IVAS.</p>	<p>L-shaped PVC base thermal break profile combined with variable end fitting, equipped with a drip profile, mesh side and connection element to reduce the risk of cracking in the area of the building plinth. The L-shaped base profile comes in two sizes to cover insulation thicknesses ranging from 8 to 24 cm. Suitable for all IVAS thermal insulation systems.</p>	<p>Perfil inicial en L en pvc de corte térmico con unión de cierre variable, dotado de gotero, malla remetida y elemento de conexión para reducir el peligro de cuarteados en el área del rodapié. El perfil inicial en L se entrega en dos medidas para poder cubrir aislamientos de espesor variable de 8 a 24 cm. Idóneo para todos los sistemas de aislamiento térmico IVAS.</p>
<p>Lunghezza barre: 2 m Confezione: da 10 barre (tot 20 m)</p>	<p>Bar Length: 2 m Package: 10 bars (total: 20 m)</p>	<p>Largo de las barras: 2 m Envase: de 10 barras (tot 20 m)</p>

rompigoccia per base di partenza-R



scheda tecnica

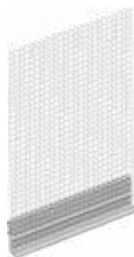

profilo di raccordo con il profilo di partenza	connection profile with the base profile	perfil de conexión con el perfil inicial
<p>Profilo in PVC con gocciolatoio e rete in fibra di vetro termosaldato per aggancio al profilo di base partenza. Riduce il pericolo di cavillature del rivestimento nella congiunzione dei profili di base-partenza.</p>	<p>PVC profile with drip edge and heat-sealed glass fibre mesh for bonding to the base profile. Reduces the risk of cracks in the coating at base profiles' connection points.</p>	<p>Perfil en PVC con gotero y malla en fibra de vidrio termosellada para el enganche al perfil de base inicial. Reduce el peligro de cuarteados del revestimiento en la unión de los perfiles de base-inicio.</p>
<p>Lunghezza barre: 2 m Confezione: 25 barre (tot 50 m)</p>	<p>Bar Length: 2 m Package: 25 bars (total: 50 m)</p>	<p>Largo de las barras: 2 m Envase: 25 barras (tot 50 m)</p>

paraspigolo angolare AL



profilo angolare di protezione in alluminio	aluminium corner bead profile	perfil angular de protección en aluminio
Profilo angolare in alluminio per il rinforzo e la protezione di tutti gli angoli, spigoli e stipiti ad angolo retto di finestre o porte.	Aluminium corner bead profile to reinforce and protect all corners, edges and right-angled window or door jambs.	Perfil angular en aluminio para el refuerzo y la protección de todos los ángulos, aristas y marcos en ángulo recto de ventanas o puertas.
Lunghezza barre: 2,5 m Confezione: da 50 barre (tot 125 m)	Bar Length: 2.5 m Package: 50 bars (total: 125 m)	Largo de las barras: 2,5 m Envase: de 50 barras (tot 125 m)

paraspigolo angolare PVC



scheda
tecnica



profilo angolare di protezione in pvc	pvc corner bead profile	perfil angular de protección en pvc
Profilo angolare in PVC per il rinforzo e la protezione di tutti gli angoli, spigoli e stipiti ad angolo retto di finestre o porte.	PVC corner bead profile to reinforce and protect all corners, edges and right-angled window or door jambs.	Perfil angular en PVC para el refuerzo y la protección de todos los ángulos, aristas y marcos en ángulo recto de ventanas o puertas.
Lunghezza barre: 2,5 m Confezione: da 50 barre (tot 125 m)	Bar Length: 2.5 m Package: 50 bars (total: 125 m)	Largo de las barras: 2,5 m Envase: de 50 barras (tot 125 m)

paraspigolo angolare AL-R



scheda
tecnica



profilo angolare di protezione in alluminio con rete	aluminium corner bead profile with mesh	perfil angular de protección en aluminio con malla
Profilo angolare in alluminio per il rinforzo e la protezione di tutti gli angoli, spigoli e stipiti ad angolo retto di finestre o porte con rete in fibra di vetro incorporata.	Aluminium corner bead profile with built-in glass fibre mesh designed to reinforce and protect all corners, edges and right-angled window or door jambs.	Perfil angular en aluminio para el refuerzo y la protección de todos los ángulos, aristas y marcos en ángulo recto de ventanas o puertas con malla de fibra de vidrio incorporada.
Misura barre: 8 cm x 12 cm x 2,5 m Confezione: da 50 barre (tot 125 m)	Bar sizes: 8 cm x 12 cm x 2.5 m Package: 50 bars (total: 125 m)	Medidas de las barras: 8 cm x 12 cm x 2,5 m Envase: de 50 barras (tot 125 m)

paraspigolo angolare PVC-R



scheda
tecnica



profilo angolare di protezione in pvc con rete	pvc corner bead profile with mesh	perfil angular de protección en pvc con malla
Profilo angolare in PVC per il rinforzo e la protezione di tutti gli angoli, spigoli e stipiti ad angolo retto di finestre o porte con rete in fibra di vetro incorporata.	PVC corner bead profile with built-in glass fibre mesh designed to reinforce and protect all corners, edges and right-angled window or door jambs.	Perfil angular en PVC para el refuerzo y la protección de todos los ángulos, aristas y marcos en ángulo recto de ventanas o puertas con malla de fibra de vidrio incorporada.
Lunghezza barre: 2,5 m Altezza lati angolare: 22 x 22mm Altezza rete: 80x120mm Confezione: da 50 barre (tot 125 m) Su richiesta altre dimensioni fino a 300mm	Bar Length: 2.5 m Profile sides height: 22 x 22mm Mesh height: 80x120mm Package: 50 bars (total: 125 m) Other sizes of up to 300mm available upon request	Largo de las barras: 2,5 m Altura de los lados del angular: 22x22mm Altura de la malla: 80X120 mm Envase: de 50 barras (tot 125 m) Bajo pedido, otras medidas hasta 300 mm

paraspigolo angolare archi PVC



scheda
tecnica



profilo angolare di protezione archi in pvc	pvc corner bead profile for archways	perfil angular de protección de arcos en pvc
Profilo angolare in PVC per il rinforzo e la protezione di tutti gli archi. Flessibile e modellabile.	PVC corner bead profile to reinforce and protect all archways. Flexible and mouldable.	Perfil angular en PVC para el refuerzo y protección de todos los arcos. Flexible y modelable.
Lunghezza barre: 3 m	Bar Length: 3 m	Largo de las barras: 3 m

paraspigolo angolare flex PVC-R



scheda
tecnica



profilo angolare di protezione in pvc ad angolo variabile	pvc corner bead profile with variable angle	perfil angular de protección en pvc en ángulo variable
Profilo angolare in PVC a rotolo, per il rinforzo e la protezione di tutti gli angoli, spigoli e stipiti ad angolo variabile di finestre o porte con rete in fibra di vetro incorporata.	Roll of PVC corner bead profile with built-in glass fibre mesh designed to reinforce and protect all corners, edges and variable-angled window or door jambs.	Perfil angular en PVC en rollo, para el refuerzo y protección de todos los ángulos, aristas y marcos en ángulo variable de ventanas o puertas con malla en fibra de vidrio incorporada.
Lunghezza rotolo: 25 m (1 rotolo in una scatola)	Roll Length: 25 m (1 roll in a box)	Largo del rollo: 25 m (1 rollo en una caja)

profilo con gocciolatoio PVC-R



scheda
tecnica

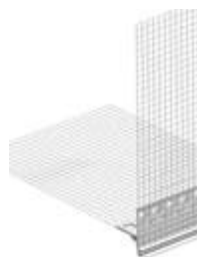

profilo angolare con gocciolatoio e rete	corner bead profile with drip edge and mesh	perfil angular con gotero y malla
<p>Profilo in PVC con rete in fibra di vetro incorporata e gocciolatoio per l'esecuzione di angoli su facciate rientranti, solai su spazi aperti (piani Pilotys), vani finestre e porte, cassette per avvolgibili, balconi ecc.</p>	<p>PVC profile with built-in glass fibre mesh and drip edge designed to prepare corners on recessed façades, floors in open spaces (Pilotys floors), window and door openings, roller shutter boxes, balconies etc.</p>	<p>Perfil en PVC con malla en fibra de vidrio incorporada y gotero para la ejecución de ángulos en fachadas entrantes, forjados en espacios abiertos (plantas bajas diáfanas con pilares), huecos de ventanas y puertas, cajas para enrollables, balcones, etc.</p>
<p>Lunghezza barre: 2,5 m Confezione: da 25 barre (tot 62,5 m)</p>	<p>Bar Length: 2.5 m Package: 25 bars (total: 62.5 m)</p>	<p>Largo de las barras: 2,5 m Envase: de 25 barras (tot 62,5 m)</p>

profilo SD sottodavanzale



profilo in alluminio sottodavanzale	aluminium undersill profile	perfil en aluminio para debajo del alféizar
<p>Profilato in lega d'alluminio naturale, antialcalino, per la chiusura e la protezione meccanica del sistema Termok8 sotto i davanzali esistenti. Dotato di gocciolatoio. Sovraverniciabile.</p>	<p>Profile in antialkaline, natural aluminium alloy designed for closure and mechanical protection of Termok8 insulation systems under existing window sills. Equipped with drip edge. It can be overpainted.</p>	<p>Perfil en aleación de aluminio natural, antialcalino, para cierre y protección mecánica del sistema Termok8 bajo los alféizares existentes. Dotado de gotero. Admite recubrimiento con pintura.</p>
<p>Lunghezza barre: 2,5 m Eventuale confezione: 10 barre (totale 25 m)</p>	<p>Bar Length: 2.5 m Package: 10 bars (total: 25 m)</p>	<p>Largo de las barras: 2,5 m Envase (en su caso): 10 barras (total 25 m)</p>

profilo finestre PVC-R



scheda
tecnica

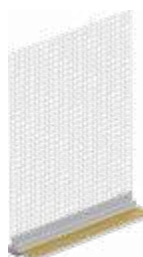

profilo di raccordo a finestra con rete	window connection profile with mesh	perfil de conexión a ventana con malla
<p>Profilo autoadesivo in PVC per il collegamento del sistema ai telai dei serramenti, preaccoppiato con rete in fibra di vetro incorporata.</p>	<p>Self-adhesive PVC profile pre-coupled with glass fibre mesh for connecting the system to window and door frames.</p>	<p>Perfil autoadhesivo en PVC para la conexión del sistema a los bastidores de los cierres, prelaminado con malla en fibra de vidrio incorporada.</p>
<p>Lunghezza barre: 2,4 m Confezione: da 30 barre (tot 72 m)</p>	<p>Bar Length: 2.4 m Package: 30 bars (total: 72 m)</p>	<p>Largo de las barras: 2,4 m Envase: de 30 barras (tot 72 m)</p>

profilo finestre plus PVC-R



scheda
tecnica



profilo di raccordo a finestra con rete	window connection profile with mesh	perfil de conexión a ventana con malla
<p>Profilo in PVC per il raccordo a tenuta d'acqua battente tra il sistema a cappotto e i telai dei serramenti, in classe 1, con nastro autoadesivo, guarnizione sigillante in PE e rete in fibra di vetro termosaldata. Dotato di una guarnizione flessibile per la compensazione di piccoli movimenti (monodimensionali).</p>	<p>PVC profile for watertight connection between external thermal insulation systems and window and door frames, class 1, with self-adhesive tape, PE seal and heat-sealed glass fibre mesh. Equipped with a flexible seal to compensate for minor (one-dimensional) movements.</p>	<p>Perfil en PVC para unión estanca a la incidencia de la lluvia entre el sistema de aislamiento térmico y los bastidores de los cierres, en clase 1, con cinta autoadhesiva, junta de sellado en PE y malla en fibra de vidrio termosellada. Dotado de una junta flexible para compensar pequeños movimientos (monodimensionales).</p>
<p>Lunghezza barre: 2,4 m Confezione: da 30 barre (tot 72 m)</p>	<p>Bar Length: 2.4 m Package: 30 bars (total: 72 m)</p>	<p>Largo de las barras: 2,4 m Envase: de 30 barras (tot 72 m)</p>

profilo finestre plus 3d PVC-R



scheda
tecnica



profilo di raccordo a finestra con rete	window connection profile with mesh	perfil de conexión a ventana con malla
<p>Profilo in PVC per il raccordo a tenuta d'acqua battente tra il sistema a cappotto e i telai dei serramenti, in classe 3, con nastro autoadesivo, guarnizione sigillante in PE e rete in fibra di vetro termosaldata. Dotato di una guarnizione flessibile per la compensazione di grandi movimenti (tridimensionali)</p>	<p>PVC profile for watertight connection between external thermal insulation systems and window and door frames, class 3, with self-adhesive tape, PE seal and heat-sealed glass fibre mesh. Equipped with a flexible seal to compensate for large (three-dimensional) movements</p>	<p>Perfil en PVC para unión estanca a la incidencia de la lluvia entre el sistema de aislamiento térmico y los bastidores de los cierres, en clase 3, con cinta autoadhesiva, junta de sellado en PE y malla en fibra de vidrio termosellada. Dotado de una junta flexible para compensar grandes movimientos (tridimensionales)</p>
<p>Lunghezza barre: 2,4 m Confezione: da 25 barre (tot 60 m)</p>	<p>Bar Length: 2.4 m Package: 25 bars (total: 60 m)</p>	<p>Largo de las barras: 2,4 m Envase: de 25 barras (tot 60 m)</p>

terminale per sottotetto PVC-R



scheda
tecnica



profilo di raccordo al sottotetto	profile for connection to roofing beam structure	perfil de conexión al desván
<p>Profilo di collegamento del sistema alla struttura del sottotetto, per garantire l'aerazione del sottotetto o la ventilazione del tetto ventilato, realizzato con un corpo rigido parainsetti in PVC e rete in fibra di vetro termosaldata.</p>	<p>Profile connecting the system to the roofing beam structure, to ensure ventilation of the roofing beam structure or ventilated roof, made of a rigid, insect-resistant PVC body and heat-sealed glass fibre mesh.</p>	<p>Perfil de conexión del sistema a la estructura del desván, para garantizar la ventilación de este o la ventilación del techo ventilado, realizado con un cuerpo rígido antiinsetos en PVC y malla en fibra de vidrio termosellada.</p>
<p>Misure: 5,5x200 cm Eventuale confezione: 25 barre (50 m)</p>	<p>Size: 5.5x200 cm Package: 25 bars (total: 50 m)</p>	<p>Medidas: 5,5x200 cm Envase (en su caso): 25 barras (50 m)</p>

profilo di collegamento PVC-R



scheda
tecnica



profilo di raccordo a lamiera	profile for connection to sheet metal	perfil de conexión a chapa
<p>Profilo in PVC per il raccordo del sistema con scossaline, davanzali o altri elementi metallici, preaccoppiato con rete in fibra di vetro. Il profilo è dotato di un grembiule flessibile utile a consentire i movimenti differenziali degli elementi metallici collegati al sistema di isolamento a cappotto, garantendo un collegamento elastico ed una tenuta impermeabile fra intonaco e parti in lamiera.</p>	<p>PVC profile pre-coupled with glass fibre mesh designed to connect the system to flashings, window sills, or other metal elements. The profile is equipped with a flexible apron to allow differential movements of the metal elements connected to the external thermal insulation system, guaranteeing an elastic connection and an impermeable seal between plaster and sheet metal parts.</p>	<p>Perfil en PVC para la unión del sistema con cubrejuntas, alféizares u otros elementos metálicos, prelaminado con malla de fibra de vidrio. El perfil está dotado de un elemento flexible útil para permitir los movimientos diferenciales de los elementos metálicos conectados al sistema de aislamiento por capas, garantizando así una conexión elástica y un ajuste impermeable entre enfoscado y piezas de chapa.</p>
<p>Lunghezza barre: 2 m Confezione: da 25 barre (tot 50 m)</p>	<p>Bar Length: 2 m Package: 25 bars (total: 50 m)</p>	<p>Largo de las barras: 2 m Envase: de 25 barras (tot 50 m)</p>

profilo di chiusura PVC-R



scheda
tecnica

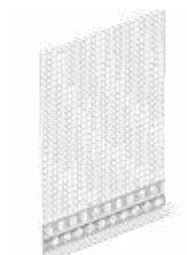

profilo di chiusura per rivestimenti di finitura a spessore	closing profile for thick finishing coats	perfil de cierre para revestimientos de acabado de espesor
<p>Il profilo di chiusura in PVC con rete permette di eseguire perfette chiusure di rivestimenti su sistemi di isolamento. Per un'interruzione a vista del sistema a cappotto, o per realizzare dei cambi di colore precisi e lineari.</p>	<p>The PVC closing profile with mesh ensures perfect closure of coatings on insulation systems. For a visible break in the external thermal insulation system or for precise, linear changes in colour.</p>	<p>El perfil de cierre en PVC con malla permite realizar cierres perfectos de los revestimientos sobre sistemas de aislamiento. Para una interrupción a la vista del sistema de aislamiento térmico, o para realizar cambios de color precisos y lineales.</p>
<p>Lunghezza barre: 2m Spessori disponibili: 3 mm, 6 mm, 8 mm, 10 mm Confezione: 25 pezzi (tot. 50 m) Altezza rete: 125 mm Grammatura rete: 160 g/m²</p>	<p>Bar Length: 2m Available thicknesses: 3 mm, 6 mm, 8 mm, 10 mm Package: 25 pieces (total 50 m) Mesh height: 125 mm Mesh Weight: 160 g/m²</p>	<p>Largo de las barras: 2m Espesores disponibles: 3 mm, 6 mm, 8 mm, 10 mm Envase: 25 piezas (tot. 50 m) Altura de la malla: 125 mm Gramaje de la malla: 160 g/m²</p>

profilo CO di contenimento



profilo di chiusura del sistema a cappotto	closing profile for external thermal insulation system	perfil de cierre del sistema de aislamiento térmico
<p>Profilato in lega d'alluminio naturale, antialcalino, per la chiusura laterale e la protezione meccanica del sistema Termok8. Sovraverniciabile.</p>	<p>Antialkaline, natural aluminium alloy profile for side closing and mechanical protection of the Termok8 insulation system. It can be overpainted.</p>	<p>Perfil en aleación de aluminio natural, antialcalino, para el cierre lateral y la protección mecánica del sistema Termok8. Admite recubrimiento con pintura.</p>
<p>Lunghezza barre: 2,5 m Eventuale confezione: 10 barre (totale 25 m)</p>	<p>Bar Length: 2.5 m Package: 10 bars (total: 25 m)</p>	<p>Largo de las barras: 2,5 m Envase (en su caso): 10 barras (total 25 m)</p>

profilo C di colmo



profilo in alluminio chiusura giunto di separazione orizzontale	aluminium closing profile for horizontal separation joints	perfil en aluminio de cierre de junta de separación horizontal
<p>Profilato in lega d'alluminio naturale, antialcalino, per la chiusura del giunto di separazione orizzontale del sistema Termok8 modular big, nonché della tenuta d'acqua battente dello stesso. Obbligatorio nel sistema di Termok8 Modular Big Spessore in funzione dell'isolante. Sovraverniciabile.</p>	<p>Antialkaline, natural aluminium alloy profile for closing horizontal separation joints in the Termok8 modular big system and ensuring its water tightness. Required in the Termok8 Modular Big system Thickness depending on insulation. It can be overpainted.</p>	<p>Perfilado en aleación de aluminio natural, antialcalino, para el cierre de la junta de separación horizontal del sistema Termok8 modular big, así como del sello estanco contra la incidencia de la lluvia. Obligatorio en el sistema de Termok8 Modular Big espesor en función del aislante. Admite recubrimiento con pintura.</p>
<p>Lunghezza barre: 2,5 m Eventuale confezione: 10 barre (totale 25 m)</p>	<p>Bar Length: 2.5 m Package: 10 bars (total: 25 m)</p>	<p>Largo de las barras: 2,5 m Envase (en su caso): 10 barras (total 25 m)</p>

profilo per rivestimenti modulari



profilo in alluminio a L di chiusuragiunto di separazione orizzontale	aluminium L-shaped closing profile for horizontal separation joints	perfil en aluminio en L de cierre de junta de separación horizontal
<p>Profilato a "L" in lega d'alluminio naturale, antialcalino, per l'interruzione del sistema e la distribuzione dei carichi con rivestimenti modulari di piccole dimensioni. Obbligatorio nei sistemi di Termok8 Modular D e Termok8 Facciavista. Spessore in funzione dell'isolante. Sovraverniciabile.</p>	<p>L-shaped profile in antialkaline, natural aluminium alloy, designed for creating gaps in the system and to distribute the loads with small modular cladding. Required in the Termok8 Modular D and Termok8 Facciavista. systems. Thickness depending on insulation. It can be overpainted.</p>	<p>Perfilado en "L" en aleación de aluminio natural, antialcalino, para la interrupción del sistema y la distribución de las cargas con revestimientos modulares de pequeño tamaño. Obligatorio en los sistemas de Termok8 Modular D y Termok8 Facciavista. Espesor en función del aislante. Admite recubrimiento con pintura.</p>
<p>Lunghezza barre: 2,5 m</p>	<p>Bar Length: 2.5 m</p>	<p>Largo de las barras: 2,5 m</p>

nastro autoespandente sigillante BG1



scheda
tecnica



nastro di guarnizione di interfaccia tra cappotto ed elementi	tape for interfacing seals between insulation system and elements	cinta para junta de interfaz entre sistema de aislamiento térmico y elementos
<p>Nastro sigillante per giunti, autoadesivo, pre-compresso e pre-impregnato che soddisfa lo standard BG1. Sigillatura a tenuta stagna contro la pioggia battente ≥ 600 Pa di tutti i giunti di raccordo tra sistema di isolamento e finestre, davanzali, travi in legno etc, in edifici nuovi o ristrutturati. Permeabile al vapore, resistente ai raggi UV con eccellenti proprietà termiche e acustiche. Può essere esposto direttamente agli agenti atmosferici. Realizzato in PU espanso.</p>	<p>Self-adhesive, pre-compressed and pre-impregnated joint sealing tape compliant with BG1 standard. Waterproof sealing against driving rain ≥ 600 Pa for all joints between the insulation system and windows and doors, window sills, wooden beams etc. Ideal for both new or renovated buildings. Vapour permeable, UV-resistant with excellent thermal and acoustic properties. Can be directly exposed to the weather. Made of PU foam.</p>	<p>Cinta selladora para juntas, autoadhesiva, precomprimida y preimpregnada que cumple con el estándar BG1. Sellado estanco contra la incidencia de la lluvia a ≥ 600 Pa de todas las juntas de unión entre sistema de aislamiento y ventanas, alféizares, vigas de madera, etc., en edificios nuevos o reacondicionados. Permeable al vapor, resistente a los rayos UV con excelentes propiedades térmicas y acústicas. Puede exponerse directamente a los agentes atmosféricos. Realizado en PU expandido.</p>
<p>Colore nero. Misure rotolo: larghezza 15 mm; lunghezza 12 m Spessore: 2,0-6,0 mm Campo d'impiego: larghezza fuga 2 - 6 mm Misure rotolo: larghezza 15 mm; lunghezza 8 m Spessore: 6,0-15,0 mm Campo d'impiego: larghezza fuga 6-15 mm</p>	<p>Color: black. Roll Size: width 15 mm; length 12 m Thickness: 2.0-6.0 mm Usage range: joint widths of 2 - 6 mm Roll Size: width 15 mm; length 8 m Thickness: 6.0-15.0 mm Usage range: joint widths of 6 - 15 mm</p>	<p>Color negro. Medidas del rollo: ancho 15 mm, largo 12 m Espesor: 2,0-6,0 mm Campo de empleo: ancho de la junta 2 - 6 mm Medidas del rollo: ancho 15 mm, largo 8 m Espesor: 6,0-15,0 mm Campo de empleo: ancho de la junta 6-15 mm</p>



rete di armatura presagomata lineare per decori in facciata	shaped linear reinforcement mesh for façade decorations	malla de armadura preformada lineal para decoraciones en fachada
Rete di vetro apprettata, antidemagliante, resistente agli alcali, pre-sagomata per l'esecuzione di scanalature orizzontali o verticali su intonaco e su pannelli isolanti con fuga predisposta.	Sized, unravel-proof mesh resistant to alkalis, shaped for making horizontal or vertical grooves in plaster and insulating panels with prepared joints.	Malla de vidrio aprestada, antidesmalante, resistente a los álcalis, preformada para la ejecución de acanaladuras horizontales o verticales en enfoscados y sobre paneles aislantes con junta preparada previamente.
Tipo 1 (trapezio stretta): 30x20x17 mm Tipo 2 (trapezio larga): 37x20x17 mm Tipo 3 (triangolare): 30x0x17 mm Lunghezza profilo: 200 cm Confezione: 10 pezzi	Type 1: 30x20x17 mm Type 2: 37x20x17 mm Type 3: 30x0x17 mm Profile Length: 200 cm Package: 10 pieces	Tipo 1: 30x20x17 mm Tipo 2: 37x20x17 mm Tipo 3: 30x0x17 mm Largo del perfil: 200 cm Envase: 10 piezas

rete fuga decorativa angolo esterno



rete di armatura presagomata ad angolo esterno per decori in facciata	shaped reinforcement mesh for outer façade corner decorations	malla de armadura preformada en el ángulo exterior para decoraciones de fachada
Rete di vetro apprettata, antidemagliante, resistente agli alcali, presagomata per l'esecuzione di scanalature ad angolo esterno su intonaco e su pannelli isolanti con fuga predisposta.	Sized, unravel-proof mesh resistant to alkalis, shaped for making outer corner grooves in plaster and insulating panels with prepared joints.	Malla de vidrio aprestada, antidesmalante, resistente a los álcalis, preformada para la ejecución de acanaladuras de ángulo externo en enfoscados y sobre paneles aislantes con junta preparada previamente.
Tipo 1 (trapezoidale stretta) 30x20x17mm Tipo 2 (trapezoidale larga) 37x20x17mm Tipo 3 (triangolare) 30x0x17mm Confezione: 10 pz	Type 1: 30x20x17 mm Type 2: 37x20x17 mm Type 3: 30x0x17 mm Package: 10 pcs	Tipo 1: 30x20x17 mm Tipo 2: 37x20x17 mm Tipo 3: 30x0x17 mm Envase: 10 piezas

rete fuga decorativa angolo interno



rete di armatura presagomata ad angolo interno per decori in facciata	shaped reinforcement mesh for internal façade corner decorations	malla de armadura preformada de ángulo interior para decoraciones en fachada
Rete di vetro apprettata, antidemagliante, resistente agli alcali, presagomata per l'esecuzione di scanalature ad angolo interno su intonaco e su pannelli isolanti con fuga predisposta.	Sized, unravel-proof mesh resistant to alkalis, shaped for making internal corner grooves in plaster and insulating panels with prepared joints.	Hidroe Malla de vidrio aprestada, antidesmalante, resistente a los álcalis, preformada para la ejecución de acanaladuras en ángulo interior sobre enfoscados y sobre paneles aislantes con junta preparada previamente.
Tipo 1 (trapezio stretta) 30x20x17mm Tipo 2 (trapezio larga) 37x20x17mm Tipo 3 (triangolo) 30x0x17mm Confezione: 10 pz	Type 1: 30x20x17 mm Type 2: 37x20x17 mm Type 3: 30x0x17 mm Package: 10 pcs	Tipo 1: 30x20x17 mm Tipo 2: 37x20x17 mm Tipo 3: 30x0x17 mm Envase: 10 piezas

profilo di giunto semplice GL-R



scheda
tecnica

	<p>profilo giunto di dilatazione lineare</p> <p>Profilo per giunti di dilatazione su superfici piane (180°) sul sistema di isolamento termico, realizzato con nastro di tenuta flessibile, precoppiato con rete in fibra di vetro. Per ampiezze massime del giunto di 5-25 mm. Con possibilità di acquisto dell'elemento di copertura estetico.</p> <p>Lunghezza barre: 2,5 m Eventuale confezione: 25 barre (tot. 62,5 m)</p>	<p>corner expansion joint profile</p> <p>Profile for expansion joints on orthogonal surfaces (90°) on thermal insulation systems, made of flexible sealing tape, pre-coupled with glass fibre mesh. For maximum joint widths of 5-25 mm. Aesthetic covering element available.</p> <p>Bar Length: 2.5 m Package: 25 bars (total: 62.5 m)</p>	<p>perfil junta de dilatación angular</p> <p>Perfil para juntas de dilatación sobre superficies ortogonales (90°) en el sistema de aislamiento térmico, realizado con cinta de ajuste flexible, prelamado con malla de fibra de vidrio. Para anchuras máximas de la junta de 5-25 mm. Con posibilidad de compra del elemento de cobertura estético.</p> <p>Largo de las barras: 2,5 m Envase (en su caso): 25 barras (total 62,5 m)</p>
--	--	--	---

profilo di giunto semplice GA-R



scheda
tecnica

	<p>profilo giunto di dilatazione angolare</p> <p>Profilo per giunti di dilatazione su superfici ortogonali (90°) sul sistema di isolamento termico, realizzato con nastro di tenuta flessibile, precoppiato con rete in fibra di vetro. Per ampiezze massime del giunto di 5-25 mm. Con possibilità di acquisto dell'elemento di copertura estetico.</p> <p>Lunghezza barre: 2,5 m Eventuale confezione: 25 barre (tot. 62,5 m)</p>	<p>linear expansion joint profile</p> <p>Profile for expansion joints on flat surfaces (180°) on thermal insulation systems, made of flexible sealing tape, pre-coupled with glass fibre mesh. For maximum joint widths of 5-25 mm. Aesthetic covering element available.</p> <p>Bar Length: 2.5 m Package: 25 bars (total: 62.5 m)</p>	<p>perfil junta de dilatación lineal</p> <p>Perfil para juntas de dilatación sobre superficies planas (180°) en el sistema de aislamiento térmico, realizado con cinta de ajuste flexible, prelamado con malla de fibra de vidrio. Para anchuras máximas de la junta de 5-25 mm. Con posibilidad de compra del elemento de cobertura estético.</p> <p>Largo de las barras: 2,5 m Envase (en su caso): 25 barras (total 62,5 m)</p>
---	---	---	--

giunto di dilatazione plus PVC-R

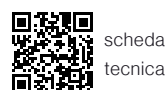

scheda
tecnica

	<p>profilo di giunto di dilatazione di piccoli movimenti</p> <p>Profilo giunto di dilatazione in PVC per garantire il contenimento di piccoli movimenti, realizzato con coprigiunto centrale e rete in fibra di vetro termosaldata. Favorisce l'assorbimento dei movimenti strutturali di assestamento nelle pareti continue. Utilizzato anche come raccordo tra i pannelli isolanti di diversa natura/tipologia. Funge anche da guida per la posa dell'intonaco e/o per l'applicazione di guaine liquide. Idoneo per raccordare il sistema a cappotto con rasature armate o per l'interruzione di rasatura armata e finitura.</p> <p>Lunghezza barre: 2,5 m Eventuale confezione: 25 barre (tot. 62,5 m)</p>	<p>expansion joint profile for minor movements</p> <p>PVC expansion joint profile to ensure containment of minor movements, made with central joint cover and heat-sealed glass fibre mesh. Helps absorb structural settling movements in curtain walls. Also used as connection between different types of insulation panels. Also serves as guide when laying plaster and/or liquid membranes. Suitable for connecting the external thermal insulation system with reinforced skim coats or for interrupting reinforced skim and topcoats.</p> <p>Size: height 7 mm, length 2.5 m Package: 25 bars (total: 62.5 m)</p>	<p>perfil de junta de dilatación de pequeños movimientos</p> <p>Perfil junta de dilatación en PVC para garantizar la contención de pequeños movimientos, realizado con tapajunta central y malla de fibra de vidrio termosoldada. Favorece la absorción de los movimientos estructurales de ajuste en las paredes continuas. También se utiliza como conexión entre los paneles aislantes de diferente naturaleza/tipo. También sirve de guía para la colocación del yeso y/o para la aplicación de fundas líquidas. Apto para conectar el sistema a capa con afeitados armados o para la interrupción del afeitado armado y acabado.</p> <p>Medidas: altura 7 mm, largo 2,5 m Envase (en su caso): 25 barras (62,5 m)</p>
--	---	--	--

kit montaggio profili di base

	set per il fissaggio dei profili di partenza e giude	set for fastening base profiles and joints	set para la fijación de los perfiles iniciales y guías
	Set per il montaggio idoneo al fissaggio di profili di partenza in sistemi ETICS Composto da: 75 tasselli a percussione ND-K 6 x 60 10 elementi di giunzione PV 30 50 elementi di compensazione AS 3	installation set suitable for fastening base profiles on ETICS systems Composed of: 75 percussion anchors ND-K 6 x 60 10 joint elements PV 30 50 compensation elements AS 3	Set de montaje idóneo para la fijación de los perfiles iniciales en sistemas SATE Formado por: 75 tacos de percusión ND-K 6 x 60 10 elementos de unión PV 30 50 elementos de compensación AS 3

elementi di compensazione

	distanziatori per profili di partenza e guide	spacers for base profiles and guides	separadores para perfiles iniciales y guías
	Per la compensazione delle tolleranze di planarità della facciata nel montaggio dei profili di partenza o delle guide per i sistemi meccanici. Adattabili a diversi diametri di tassello ed accoppiabili per coprire le più svariate tolleranze. Ciascuno spessore ha una colorazione differente per un rapido riconoscimento in cantiere.	To compensate for tolerance in façade flatness during installation of base profiles or mechanical system guides. Can be adapted for various anchor diameters and coupled to cover a wide range of tolerances. To ensure easy recognition at the construction site, each thickness has a different colour.	Para la compensación de las tolerancias de planicidad de la fachada en el montaje de los perfiles de inicio o de las guías para los sistemas mecánicos. Adaptables a distintos diámetros de taco y acoplables para cubrir las más diversas tolerancias. Cada espesor tiene un color distinto para su rápido reconocimiento en obra.

tassello di ancoraggio a spirale

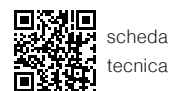

	tassello di ancoraggio di carichi leggeri a cappotto ultimato	anchor for light loads after external thermal insulation system has been completed	taco de anclaje de cargas ligeras al sistema de aislamiento térmico terminado
	Tassello in plastica a forma di spirale, con rondella di tenuta e alloggiamento interno filettato per una vite, per l'ancoraggio di oggetti leggeri su sistemi ETICS già intonacati (indipendente dallo spessore di isolamento), senza formazione di ponte termico. Esempi di applicazione: numeri civici, cassette postali piccole, lampade, punti luce, insegne leggere ecc. Portata consigliata: 5 kg Contenuto 1 scatola: 100 pezzi	Spiral-shaped plastic anchor with sealing washer and threaded inner housing for a screw, used to anchor lightweight objects on previously plastered ETICS systems (of any insulation thickness), without forming a thermal bridge. Examples of Applications: house numbers, small mailboxes, lamps, spotlights, light-weight signs, etc. Recommended Weight: 5 kg Contents in 1 box: 100 pieces	Taco de plástico en forma de espiral, con arandela de ajuste y alojamiento interior roscado para un tornillo, para anclaje de objetos ligeros en sistemas SATE ya enfoscados (independiente del espesor de aislamiento), sin formación de puente térmico. Ejemplos de Aplicaciones: números urbanos, buzones postales pequeños, lámparas, puntos de luz, rótulos ligeros, etc. Capacidad aconsejada: 5 kg Contenido 1 caja: 100 piezas

inserto dart-set



scheda
tecnica



<p>set fissaggio di carichi leggeri-medi a cappotto ultimato</p>	<p>set for fastening light and medium-weight loads after external thermal insulation system has been completed</p>	<p>set de fijación de cargas ligeras-medias a sistema de aislamiento térmico terminado</p>
<p>Elemento di fissaggio costituito da una boccia di montaggio in materiale plastico con guarnizione di tenuta in EPDM ed un tassello per facciata (Ø 8mm). Utilizzato per il montaggio di carichi non pianificati da leggeri a medi su sistemi ETICS già intonacati in EPS, lana minerale, senza formazione di ponte termico.</p>	<p>Fixing element consisting of a plastic mounting bush with EPDM sealing gasket and a dowel for the facade (Ø 8mm). Used for mounting light to medium unplanned loads on ETICS systems already plastered in EPS, mineral wool, without forming a thermal bridge.</p>	<p>Elemento de fijación compuesto por un casquillo de montaje de plástico con junta de estanqueidad de EPDM y un taco para la fachada (Ø 8 mm). Se utiliza para el montaje de cargas no planificadas de ligeras a medias sobre sistemas SATE ya revestidos de EPS, lana mineral, sin formar puente térmico.</p>
<p>Portata consigliata: 15 kg Diametro foro: 8 mm Profondità foratura: 80 mm Azionamento: Torx T30 Applicazione: staffe pluviali, ganci fermaimposte, cassette postali, lampade, punti luce, insegne, rilevatori di movimento ecc. Contenuto del kit: 10 Boccole - 10 Guarnizioni - 10 inserti per Ø 6 mm - 10 tasselli per facciata diametro 8 mm - 1 bit di montaggio</p>	<p>Recommended load: 15 kg Hole diameter: 8 mm Drilling depth: 80 mm Drive: Torx T30 Application: rain brackets, shutter hooks, mailboxes, lamps, lights, signs, motion detectors, etc. Kit contents: 10 Bushings - 10 Gaskets - 10 inserts for Ø 6 mm - 10 dowels for facade diameter 8 mm - 1 mounting bit</p>	<p>Capacidad aconsejada: 15 kg Diámetro del orificio: 8 mm Profundidad de perforación: 80 mm Accionamiento: Torx T30 Aplicación: soportes de lluvia, ganchos de persianas, buzones, lámparas, luces, letreros, detectores de movimiento, etc. Contenido del kit: 10 casquillos - 10 juntas - 10 insertos para Ø 6 mm - 10 tacos para fachada Ø 8 mm - 1 punta de montaje</p>

iso-bar



scheda
tecnica



<p>barra di fissaggio di carichi medi-pesanti a cappotto ultimato</p>	<p>fastening bar for medium to heavy loads after the external thermal insulation system has been completed</p>	<p>barra de fijación de cargas medias-pesadas a sistema de aislamiento térmico terminado</p>
<p>Barra in fibra di vetro con perno di montaggio in acciaio inox per il montaggio pianificato o non pianificato di carichi pesanti su sistemi ETICS già intonacati, senza formazione di ponte termico. Barra in fibra di vetro selezionabile a misura direttamente in cantiere. Certificazione dei valori di carico e di trasmittanza termica.</p>	<p>Glass fibre bar with stainless steel installation pin for both planned and unplanned installation of heavy loads on previously plastered ETICS systems without creating thermal bridges. Glass fibre bar, can be custom sized directly on site. Certification of load and thermal transmittance values.</p>	<p>Barra en fibra de vidrio con perno de montaje en acero inox para el montaje planificado o no planificado de cargas pesadas en sistemas SATE ya enfoscados, sin formación de puente térmico. Barra en fibra de vidrio seleccionable a medida directamente en obra. Certificación de los valores de carga y de transmitancia térmica.</p>
<p>Applicazione: tende da sole, pensiline, climatizzatori, insegne, antenne paraboliche ecc. Contenuto del kit: 1 Iso-Bar, 1 boccia per il montaggio, 1 rondella con guarnizione di tenuta in EPDM, 1 dado M12 per il fissaggio di carico.</p>	<p>Examples of Applications: awnings, canopies, air conditioners, signs, satellite dishes, etc. Contents of the kit: 1 Iso-Bar, 1 installation bush, 1 washer with EPDM seal, 1 M12 nut to fasten load.</p>	<p>Ejemplos de Aplicaciones: toldos, marquesinas, climatizadores, rótulos, antenas parabólicas, etc. Contenido del kit: 1 Iso-Bar, 1 casquillo para el montaje, 1 arandela conjunta de ajuste en EPDM, 1 tuerca M12 para la fijación de carga.</p>



elemento in eps per il posizionamento di interruttori e punto luce	eps element for positioning switches and spotlights	elemento in eps para la colocación de interruptores y puntos de luz
<p>Cassetta elettrica isolante, costituita da una scatola e da quattro piedini realizzati in poliammide, applicati in uno stampato in EPS, idonea per il fissaggio sicuro dei componenti elettrici. Le alimentazioni cavi o tubi sono chiuse con dei tappini ciechi in EPS. Permette una installazione integrata al sistema ETICS facile ed efficiente. Garantisce l'assenza di ponte termico e la tenuta all'aria. Testate anche per il Blower Door Test.</p>	<p>Insulated electrical box, composed of a box and four polyamide feet, applied in moulded EPS unit suitable for safe securing of electrical components. The power supply cables or ducts are sealed with EPS blind plugs. Enables easy, efficient installation integrated with the ETICS system. Ensures that there are no thermal bridges and guarantees airtightness. Also tested for the Blower Door Test.</p>	<p>Caja eléctrica aislante, constituida por una caja y cuatro patas realizadas en poliamida, aplicadas en una estampación en EPS, idónea para la fijación segura de los componentes eléctricos. Las alimentaciones, cables o tubos, se cierran con tapones ciegos en EPS. Permite una instalación integrada en el sistema SATE fácil y eficiente. Garantiza la ausencia de puente térmico y la estanqueidad al aire. Probadas también para el Blower Door Test.</p>
<p>Spessori disponibili: 80 - 300 mm Dimensioni: 150 x 150 mm Peso specifico EPS: 30 kg/m³ Inserto: Vimark 503 - V71303 Resistenza al fuoco: GW 650 °C Conducibilità termica: $\lambda = 0.031$ W/mK</p>	<p>Available thicknesses: 80 - 300 mm Size: 150 x 150 mm EPS Specific Weight: 30 kg/m³ Insert: Vimark 503 - V71303 Fire resistance: GW 650 °C Thermal conductivity: $\lambda = 0.031$ W/mK</p>	<p>Espesores disponibles: 80 - 300 mm Medidas: 150 x 150 mm Peso específico EPS: 30 kg/m³ Inserto: Vimark 503 - V71303 Resistencia al fuego: GW 650 °C Conductividad térmica: $\lambda = 0.031$ W/mK</p>

inserto di rinforzo Quadroline

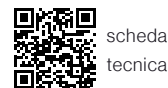

cubo di montaggio in eps per l'applicazione di carichi medi	eps mounting cube for applying medium loads	cubo de montaje en eps para la aplicación de cargas medias
<p>Cubo di fissaggio in EPS ad alta densità per il fissaggio di carichi leggeri e medi nei sistemi ETICS senza formazione di ponte termico. Funge inoltre da spessore di appoggio in caso di carichi intermedi.</p>	<p>Fastening cube made of high density EPS for fastening light and medium loads in ETICS systems without forming a thermal bridge. It also acts as a support shim for intermediate loads.</p>	<p>Cubo de fijación en EPS de alta densidad para la fijación de cargas ligeras y medias en los sistemas SATE sin formación de puente térmico. Hace además de espesor de apoyo en caso de cargas intermedias.</p>
<p>Spessori disponibili: 60 - 300 mm Dimensione: 100 x 100 mm Peso specifico: 160 kg/m³ Conducibilità termica: $\lambda = 0.051$ W/mK Portata consigliata: 15 kg per elemento Applicazioni: gronde, luci da esterno, allarmi, telecamere, etc... Certificazione dei valori di carico e di trasmittanza.</p>	<p>Available thicknesses: 60 - 300 mm Size: 100 x 100 mm Specific Weight: 160 kg/m³ Thermal conductivity: $\lambda = 0.051$ W/mK Recommended weight: 15 kg per element Applications: gutters, outdoor lights, alarms, cameras, etc... Certification of load and transmittance values.</p>	<p>Espesores disponibles: 60 - 300 mm Medidas: 100 x 100 mm Peso específico: 160 kg/m³ Conductividad térmica: $\lambda = 0.051$ W/mK Capacidad aconsejada: 15 kg por elemento Aplicaciones: canaletas, luces de exterior, alarmas, cámaras de video, etc... Certificación de los valores de carga y de transmitancia.</p>

blocco di montaggio quadroline PU



Cubo di fissaggio in PU giallo utilizzabile come spessore di compressione per il fissaggio di carichi senza deformazione o rottura del sistema ETICS. Le viti di fissaggio trapassano il Quadroline PU fino la superficie portante. Permettono di avvitare il carico senza schiacciare il sistema ETICS.	Fastening cube made of yellow PU that can be used as a compression shim for fastening loads without deforming or breaking the ETICS system. The fastening screws run through the Quadroline PU up to the load-bearing surface. They allow the load to be screwed down without compressing the ETICS system.	Cubo de fijación de PU amarillo utilizable como espesor de compresión para la fijación de cargas sin deformación o rotura del sistema SATE. Los tornillos de fijación atraviesan el Quadroline PU hasta la superficie portante. Permiten atornillar la carga sin aplastar el sistema SATE.
<p>Spessori disponibili: 60 - 300 mm Dimensione: 198 x 198 mm Peso specifico: 200 kg/m³ Superficie utile: 198 x 198 mm Applicazioni: condizionatori, tende da sole, pensiline, tettoie, pergolati, etc. Certificazione dei valori di schiacciamento e di trasmittanza.</p>	<p>Available thicknesses: 60 - 300 mm Size: 198 x 198 mm Specific weight: 200 kg/m³ Useful surface area: 198 x 198 mm Applications: air conditioners, awnings, canopies, shelters, pergolas, etc. Certification of compression and transmittance values.</p>	<p>Espesores disponibles: 60 - 300 mm Medidas: 198 x 198 mm Peso específico: 200 kg/m³ Superficie útil: 198 x 198 mm Aplicaciones: acondicionadores, toldos, marquesinas, tejadillos, pérgolas, etc. Certificación de los valores de aplastamiento y de transmitancia.</p>

barra di fissaggio Vari Q



scheda
tecnica



barra sezionabile in eps per l'applicazione di carichi medi	eps bar, divisible in sections, for applying medium loads	barra seccionable en eps para la aplicación de cargas medias
Barra di fissaggio in EPS sezionabile multi spessore ad alta densità per il fissaggio di carichi leggeri e medi nei sistemi ETICS senza formazione di ponte termico. Funge inoltre da spessore di appoggio in caso di carichi intermedi.	Divisible, multi-thickness fastening bar of high-density EPS for fastening light and medium-weight loads in ETICS systems without forming a thermal bridge. It also acts as a support shim for intermediate loads.	Barra de fijación en EPS seccionable, multiespesor de alta densidad para la fijación de cargas ligeras y medias en los sistemas SATE sin formación de puente térmico. Hace además de espesor de apoyo en caso de cargas intermedias.
Dimensione: 100 x 100 x 1000 mm Peso specifico: 140 kg/m ³ Conducibilità termica: $\lambda = 0,047$ W/mK Portata consigliata: 15 kg per elemento Applicazioni: gronde, luci da esterno, allarmi, telecamere, etc... Certificazione dei valori di carico e di trasmittanza.	Size: 100 x 100 x 1000 mm Specific Weight: 140 kg/m ³ Thermal conductivity: $\lambda = 0.047$ W/mK Recommended weight: 15 kg per element Applications: gutters, outdoor lights, alarms, cameras, etc... Certification of load and transmittance values.	Medidas: 100 x 100 x 1000 mm Peso específico: 140 kg/m ³ Conductividad térmica: $\lambda = 0,047$ W/mK Capacidad aconsejada: 15 kg por elemento Aplicaciones: canaletas, luces de exterior, alarmas, cámaras de vídeo, etc... Certificación de los valores de carga y de transmitancia.

supporto di fissaggio K1-PE



scheda
tecnica



elemento di fissaggio di cardini e inferriate	fastening element for awnings, shelters and canopies	elemento de fijación de toldos, marquesinas y tejadillos
Elemento di fissaggio ad angolo in poliuretano con armatura in fibra di vetro e piedini di regolazione per il fissaggio di cardini/inferriate sui sistemi ETICS senza formazione di ponte termico.	Rectangular polyurethane plate with steel, aluminium and phenolic resin reinforcement for fastening very heavy loads in ETICS systems without forming a thermal bridge.	Placa rectangular en poliuretano con armadura en acero, aluminio y resina fenólica para la fijación en los sistemas SATE de cargas muy pesadas sin formación de puente térmico.
Dimensione: 240 x 125 mm Superficie utile: 108 x 48 mm Peso specifico: 350 kg/m ³ Portata consigliata: 60 kg per elemento Applicazioni: cardini, persiane scorrevoli, inferriate Certificazione dei valori di carico e di trasmittanza.	Dimension: 240 x 125 mm Useful surface: 108 x 48 mm Specific weight: 350 kg / m ³ Recommended load: 60 kg per element Applications: hinges, sliding shutters, railings Certification of load and transmittance values.	Dimensión: 240 x 125 mm Superficie útil: 108 x 48 mm Peso específico: 350 kg/m ³ Carga recomendada: 60 kg por elemento Aplicaciones: bisagras, contraventanas correderas, barandillas Certificación de valores de carga y transmitancia.

stefte di montaggio TRA-WIK-PU



scheda
tecnica



Elementi di fissaggio ad angolo in poliuretano per il fissaggio di cardini/inferriate/parapetti sui sistemi ETICS senza formazione di ponte termico. Fissaggio possibile sia sul fronte facciata che sul lato imbotte. Spessore accorciabile a piacere se necessario.	Polyurethane corner fastening elements for fastening hinges/gratings/parapets on ETICS systems without forming a thermal bridge. Fastening is possible on both the façade and the intrados side. Thickness can be shortened as required.	Elemento de fijación en ángulo en poliuretano con armadura en acero, aluminio y resina fenólica para la fijación de goznes/rejas/parapetos en sistemas SATE sin formación de puente térmico en el frente de fachada.
Spessori disponibili: 80 – 300 mm Dimensione: 280 x 125 mm Peso specifico: 550 kg/m ³ Superficie utile facciata: 85 x 20 mm Superficie utile laterale: 85 x sp. TRA WIK PU -40 mm Portata massima consigliata: 100 kg per elemento Applicazioni: cardini, persiane scorrevoli, parapetti, inferriate. Certificazione dei valori di carico e di trasmittanza.	Available thicknesses: 80 – 300 mm Size: 280 x 125 mm Specific Weight: 550 kg/m ³ Useful surface area of the façade: 85 x 20 mm Useful side surface area: 85 x TRA WIK PU -40 mm th. Maximum recommended weight: 100 kg per element Applications: hinges, sliding shutters, parapets, gratings. Certification of load and transmittance values.	Espesores disponibles: 80 – 300 mm Medidas: 280 x 125 mm Peso específico: 550 kg/m ³ Superficie útil de fachada: 85 x 20 mm Superficie útil lateral: 85 x esp. TRA WIK PU -40 mm Capacidad máxima aconsejada: 100 kg por elemento Aplicaciones: goznes, persianas deslizantes, parapetos, rejas. Certificación de los valores de carga y de transmitancia.

piastra per carichi pesanti UMP-ALU-TR



scheda
tecnica



elemento di fissaggio di tende da sole, pensiline e tettoie	fastening element for hinges and gratings	elemento de fijación de goznes y rejas
<p>Piastra rettangolare in poliuretano con armatura in acciaio, alluminio e resina fenolica per il fissaggio nei sistemi ETICS di carichi molto pesanti senza formazione di ponte termico.</p>	<p>Polyurethane corner fastening element with glass fibre reinforcement and adjusting feet for fastening hinges/gratings on ETICS systems without forming a thermal bridge.</p>	<p>Elemento de fijación en ángulo en poliuretano con armadura en fibra de vidrio y patas de ajuste para la fijación de goznes/rejas en sistemas SATE sin formación de puente térmico.</p>
<p>Spessori disponibili: 80 – 300 mm Dimensione: 238 x 138 mm Superficie utile: 162 x 80 mm Peso specifico: 350 kg/m³ Portata consigliata: 900 kg per elemento Certificazione dei valori di carico e di trasmittanza.</p>	<p>Available thicknesses: 80 - 300 mm Dimension: 238 x 138 mm Useful surface: 162 x 80 mm Specific weight: 350 kg / m³ Recommended load: 900 kg per element Certification of load and transmittance values.</p>	<p>Espesores disponibles: 80 - 300 mm Dimensión: 238 x 138 mm Superficie útil: 162 x 80 mm Peso específico: 350 kg / m³ Carga recomendada: 900 kg por elemento Certificación de valores de carga y transmitancia.</p>

certificazioni



varitherm 320



scheda
tecnica

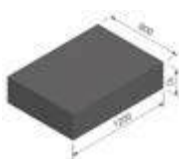

<p>Materiale da costruzione in EPS ad elevatissima densità indicato per tutti i punti del cantiere dove è richiesta un'elevata resistenza alla compressione, un elevato isolamento termico e una buona capacità di inassorbimento all'acqua.</p>	<p>Very high-density EPS building material suitable for all worksite locations where high compressive strength, high thermal insulation, and good water non-absorption capacity are required.</p>	<p>Material de construcción en EPS de elevadísima densidad indicado para todos los puntos de la obra donde se requiera una elevada resistencia a la compresión, un elevado aislamiento térmico y una buena capacidad antiabsorbente frente al agua.</p>
<p>Spessori disponibili: 10-20-30-40-50-60-80-100 mm Dimensione: 800 x 1200 mm Peso specifico: 320 kg/m³ Applicazioni: parapetti su frontalino in cls, tende da sole, pensiline, basamento di murature, etc etc. Certificazione dei valori di schiacciamento e di trasmittanza.</p>	<p>Available thicknesses: 10-20-30-40-50-60-80-100 mm Size: 800 x 1200 mm Specific weight: 320 kg/m³ Applications: parapets on concrete façade, awnings, canopies, masonry base, etc. Certification of compression and transmittance values.</p>	<p>Espesores disponibles: 10-20-30-40-50-60-80-100 mm Medidas: 800 x 1200 mm Peso específico: 320 kg/m³ Aplicaciones: parapetos en frontales de hormigón, toldos, marquesinas, cimientos de paredes, etc. Certificación de los valores de aplastamiento y de transmitancia.</p>



elemento di fissaggio di cardini e inferriate	fastening element for hinges and gratings	elemento de fijación de goznes y rejas
<p>Elemento di fissaggio ad angolo in poliuretano per il fissaggio di cardini/inferriate sui sistemi ETICS senza formazione di ponte termico. Fissaggio possibile sia sul fronte facciata che sul lato imbotte. Spessore accorciabile a piacere se necessario.</p>	<p>Polyurethane corner fixing element for fixing hinges/railings on ETICS systems without thermal bridge formation. Fixing possible both on the front and on the side imbotte. Thickness can be shortened if necessary.</p>	<p>Elemento de fijación en ángulo de poliuretano para la fijación de bisagras/rejas en los sistemas SATE sin formación de puente térmico. Fijación posible tanto en el frente de la fachada como en el lado de entrada. Espesor acortable si es necesario.</p>
<p>Dimensione: 270 x 140 mm Superficie utile facciata: 100 x 10mm Superficie utile spalletta: (Dimensione ISO-CORNER-LIGHT) Portata consigliata: 35 kg per elemento Applicazioni: cardini, persiane scorrevoli, inferriate Certificazione dei valori di carico e di trasmittanza.</p>	<p>Size: 270 x 140 mm Useful surface area of the façade: 100 x 10mm Useful surface area of the reveal: (ISO-CORNER-LIGHT size) Recommended load capacity: 35 kg per element Applications: hinges, sliding shutters, railings Load and transmittance values certified.</p>	<p>Medidas: 270 x 140 mm Superficie útil de fachada: 100 x 10mm Superficie útil de la jamba: (Tamaño ISO-CORNER-LIGHT) Capacidad recomendada: 35 kg por artículo Aplicaciones: bisagras, persianas correderas, pasamanos Certificación de los valores de carga y transmitancia.</p>



elemento di fissaggio di cardini e inferriate	fastening element for hinges and gratings	elemento de fijación de goznes y rejas
<p>Consolle ad angolo in poliuretano ad alta densità, per il montaggio pianificato di carichi pesanti su sistemi ETICS senza formazione di ponte termico sul fronte facciata o in imbotte finestra. Selezionabile a misura direttamente in cantiere (anche in posa).</p>	<p>Corner console made of high-density polyurethane, for the planned installation of heavy loads on ETICS systems without forming a thermal bridge on the façade or in the window intrados. Can be selected to size directly on site (also on installation).</p>	<p>Consolas en ángulo en poliuretano de alta densidad, para el montaje planificado de cargas pensadas en sistemas SATE sin formación de puente térmico en el frente de la fachada o en el intradós de la ventana. Seleccionable a medida directamente en obra (también en colocación).</p>
<p>Dimensione: 270 x 142,5 mm Superficie utile facciata: 100 x 10mm Superficie utile spalletta: 100 x Spessore Isocorner - 40mm Spessori disponibili: 14, 20, 30 cm Applicazioni: parapetti, cardini in imbotte, persiane scorrevoli, inferriate. Certificazione dei valori di carico</p>	<p>Size: 270 x 142.5 mm Useful surface area of the façade: 100 x 10mm Useful surface area of the reveal: 100 x Isocorner thickness - 40mm Available thicknesses: 14, 20, 30 cm Applications: parapets, hinges in intrados, sliding shutters, gratings. Certification of load values</p>	<p>Medidas: 270 x 142,5 mm Superficie útil de fachada: 100 x 10mm Superficie útil de la jamba: 100 x Espesor Isocorner - 40mm Espesores disponibles: 14, 20, 30 cm Aplicaciones: parapetos, goznes en intradós, persianas deslizantes, rejas. Certificación de los valores de carga</p>

iso-corner kit SDF



scheda
tecnica



tasselli di fissaggio iso-corner su supporti A, B, C, D	iso-corner anchors on A, B, C, D substrates	tacos de fijación iso-corner sobre soportes A, B, C, D
Set di tasselli per fissaggio su supporti in calcestruzzo (A), muratura piena (B), forata (C) o calcestruzzo alleggerito (D). Zona di espansione ottimizzata per una perfetta tenuta anche su materiali più problematici. Espansione radiale per una maggiore sicurezza di ancoraggio. Superficie della vite priva di cromo esavalente Cr(VI). Doppia alettatura di sicurezza antitorsione per un montaggio più sicuro	Set of dowels for fastening to concrete (A), solid masonry (B), perforated masonry (C) or lightweight concrete (D). Optimised expansion zone for perfect sealing even on the most problematic materials. Radial expansion for greater anchorage security. Screw surface free of hexavalent chromium Cr(VI). Double anti-twist safety fins for safer mounting	Set de tacos para fijación en soportes de hormigón (A), paredes de ladrillo macizo (B), perforado (C) u hormigón aligerado (D). Zona de expansión optimizada para un perfecto ajuste incluso en los materiales más problemáticos. Expansión radial para una mayor seguridad de anclaje. Superficie del tornillo libre de cromo hexavalente Cr(VI). Sistema de dobles aletas de seguridad antitorsión para un montaje más seguro
Profondità di foratura: ≥ 80 mm Profondità di ancoraggio: ≥ 70 mm Diametro foratura: 10 mm	Drilling depth ≥ 80 mm Anchoring depth ≥ 70 mm Drilling Diameter: 10 mm	Profundidad de perforación: ≥ 80 mm Profundidad de anclaje: ≥ 70 mm Diámetro de perforación: 10 mm

certificazioni



iso-corner kit SDP



scheda
tecnica



tasselli di fissaggio iso-corner su supporti E	anchors for fastening iso-corner on E substrates	tacos de fijación iso-corner sobre soportes E
Set di tasselli per fissaggio su supporti in CLS cellulare (E). Tasselli da facciata con vite a doppio diametro. Ancoraggio sicuro grazie alla zona di espansione combinata. Elevata capacità di carico.	Set of dowels for fastening on cellular concrete substrates (E). Façade anchors with double-diameter screw. Safe anchoring thanks to the combined expansion zone. High load capacity.	Set de tacos para fijación sobre soportes en CLS celular (E). Tacos de fachada con tornillo de doble diámetro. Anclaje seguro gracias a la zona de expansión combinada. Alta capacidad de carga.
Profondità di foratura: ≥ 80 mm Profondità di ancoraggio: ≥ 70 mm Diametro foratura: 10 mm	Drilling depth ≥ 80 mm Anchoring depth ≥ 70 mm Drilling Diameter: 10 mm	Profundidad de perforación: ≥ 80 mm Profundidad de anclaje: ≥ 70 mm Diámetro de perforación: 10 mm

certificazioni



davanzali GFB



scheda
tecnica



davanzale isolante prefinito	pre-finished insulating sill	alféizar aislante con acabado previo
<p>Davanzale isolante in GFB (cemento rinforzato in fibra di vetro) accoppiato con EPS ad alta densità 30 kg/m³, atto ad eliminare ponti termici in corrispondenza delle soglie delle finestre. Finitura verniciabile in cantiere. Utilizzabile sia su nuove costruzioni che ristrutturazioni.</p>	<p>GFB (glass-fibre reinforced concrete) insulating window sill coupled with 30 kg/m³ high density EPS, to eliminate thermal bridges at window sills. Finish can be painted on site. Can be used on both new buildings and renovations.</p>	<p>Alféizar aislante en GFB (cemento reforzado en fibra de vidrio) laminado con EPS de alta densidad 30 kg/m³, perfecto para eliminar puentes térmicos en los vanos de las ventanas. El acabado admite recubrimiento de pintura en obra. Utilizable tanto en nuevas construcciones como en reacondicionamientos.</p>

davanzali ALU



scheda
tecnica



davanzale in alluminio	aluminium window sill	alféizar en aluminio
<p>Davanzale in lega di alluminio 20/10 (sp. 2 mm) utilizzabile sia su nuove costruzioni che ristrutturazioni. Su richiesta verniciatura in produzione (solo tinte RAL).</p>	<p>Window sill made of 20/10 aluminium alloy (th. 2 mm) Can be used on both new buildings and renovations. Upon request, can be painted in production (only RAL colours).</p>	<p>Alféizar en aleación de aluminio 20/10 (esp. 2 mm) utilizable tanto en nuevas construcciones como en reacondicionamientos. Bajo pedido, pintado de fábrica (solo tintes RAL).</p>

armatex C1



scheda
tecnica



data
sheet



ficha
técnica



rete di armatura 160 gr/m ²	reinforcement mesh - 160 g/m ²	malla de armadura 160 gr/m ²
<p>Rete di armatura in fibra di vetro appretata, antidemagliante, resistente agli alcali, per sistemi di isolamento termico e in generale idonea per rasature armate con rasanti-collanti della gamma IVAS. Certificata come componente integrante del sistema di isolamento termico a cappotto. Dotato di omologazione secondo EAD 00416-00-0404</p> <p>Colore: grigia con scala graduata per il montaggio. Categoria all'urto: I e II Resistenza all'urto: 3 Joule e fino a 10 Joule con EPS MAX Misure: 1,10 x 50 m per totali 55 m² Peso: 160 g/m² Resa (con le necessarie sovrapposizioni): 1,10 m² di rete per 1 m² di supporto</p>	<p>Sized, unravel-proof, glass fibre reinforcement mesh, resistant to alkalis, designed for thermal insulation systems and, in general, suitable for reinforced skimming with the IVAS line of adhesive-skim coats. Certified as an integral component of the external thermal insulation system. Certified according to EAD 00416-00-0404</p> <p>Colours available: grey with linear graduation for installation. Impact category I and II Impact resistance: 3 Joules and up to 10 Joules with EPS MAX Size: 1.10 x 50 m for a total of 55 m² Weight: 160 g/m² Coverage (with required overlapping): 1.10 m² of mesh per 1 m² of substrate</p>	<p>Malla de armadura en fibra de vidrio apretada, antidesmallante, resistente a los álcalis, para sistemas de aislamiento térmico y en general idónea para enrasados armados con morteros de enrasado-colas de la gama IVAS. Certificada como componente integrante del sistema de aislamiento térmico por capas. Homologado según EAD 00416-00-0404</p> <p>Gama de colores: gris con escala graduada para el montaje. Categoría de impacto: I y II Resistencia al impacto: 3 julios y hasta 10 julios con EPS MÁX Medidas: 1,10 x 50 m por un total de 55 m² Peso: 160 g/m² Rendimiento (con las necesarias superposiciones): 1,10 m² de malla por 1 m² de soporte</p>

certificazioni



armatex C1 R



scheda
tecnica



data
sheet



ficha
técnica



rete di armatura 380 gr/m ²	reinforcement mesh - 380 g/m ²	malla de armadura 380 gr/m ²
<p>Rete di armatura in fibra di vetro appretata, antidemagliante, resistente agli alcali, apposta per migliorare la resistenza meccanica agli urti sui sistemi di isolamento a cappotto in particolare modo nella zona della zoccolatura. Certificata come componente integrante del sistema di isolamento termico a cappotto.</p> <p>Colore: gialla Categoria all'urto: I Resistenza all'urto: 10 Joule Misure: 1 x 25 m per totali 25 m² Peso: 380 g/m² Resa (con le sovrapposizioni) 1,10 m² di rete per 1 m² di supporto</p>	<p>Sized, unravel-proof, glass fibre reinforcement mesh, resistant to alkalis, designed to improve mechanical impact resistance on external thermal insulation systems, particularly in the area of building plinths. Certified as an integral component of the external thermal insulation system.</p> <p>Color: yellow Impact category I Impact resistance: 10 Joule Size: 1 x 25 m for a total of 25 m² Weight: 380 g/m² Coverage (with required overlapping) 1.10 m² of mesh per 1 m² of substrate</p>	<p>Malla de armadura en fibra de vidrio apretada, antidesmallante, resistente a los álcalis, idónea para mejorar la resistencia mecánica a los golpes en los sistemas de aislamiento por capas y en particular en la zona de rodapié. Certificada como componente integrante del sistema de aislamiento térmico por capas.</p> <p>Color: amarilla Categoría de impacto: I Resistencia al impacto: 10 julios Medidas: 1 x 25 m por un total de 25 m² Peso: 380 g/m² Rendimiento (con los solapamientos) 1,10 m² de malla por 1 m² de soporte</p>

certificazioni





rete di armatura 225 gr/m ²	reinforcement mesh - 225 g/m ²	malla de armadura 225 gr/m ²
Rete di armatura in fibra di vetro apprettata, antidemagliante, resistente agli alcali, per sistemi di isolamento Termok8 Modulari. Dotato di omologazione secondo EAD 00416-00-0404 Necessaria per Termok8 Modulare e consigliata per Termok8 texture design	Sized, unravel-proof, glass fibre reinforcement mesh, resistant to alkalis, designed for the Termok8 modular insulation systems. Certified according to EAD 00416-00-0404 . Required for the Termok8: Modular system and recommended for the Termok8 texture design	Malla de armadura en fibra y vidrio apretada, antidesmallante, resistente a los álcalis para sistemas de aislamiento Termok8 Modulares. Homologado según EAD 00416-00-0404 . Necesaria para Termok8 Modular y aconsejada para Termok8 texture design
Colore: grigia con scala graduata per il montaggio. Resistenza all'urto: 20Joule con EPS MAX e 60 Joule con Klebocem R110J Misure: 1 x 50 m per totali 50 m ² Peso: 225 g/m ² Resa (con le necessarie sovrapposizioni): 1,10 m ² di rete per 1 m ² di supporto	Colours available: grey with linear graduation for installation. Impact resistance: 20 Joule with EPS MAX and 60 with Klebocem R110J Size: 1 x 50 m for a total of 50 m ² Weight: 225 g/m ² Coverage (with required overlapping): 1.10 m ² of mesh per 1 m ² of substrate	Colores: gris con escala graduada para el montaje. Resistencia al impacto: 20 julios con EPS MÁX y 60 con Klebocem R110J Medidas: 1 x 50 m por un total de 50 m ² Peso: 225 g/m ² Rendimiento (con las superposiciones): 1,10 m ² de malla por 1 m ² de soporte

certificazioni



rete angolare per intradossi aperture



angolare preformato per imbotti aperture con armatura diagonale	shaped corner mesh for diagonally reinforced window and door intradoses	angular preformato para intradoses de aberturas con armadura diagonal
Angolare preformato tridimensionale utilizzato per il rinforzo diagonale e degli angoli interni di imbotti di porte e finestre per sistemi di isolamento a cappotto. Pre-piegato e presaldato. Realizzato con rete di armatura in fibra di vetro di tipo E, impregnata con resine anti-alkaline SBR, interasse 3,5 x 3,8 mm	Three-dimensionally shaped corner mesh used for diagonal and internal corner reinforcement of window and door intradoses for external thermal insulation systems. Pre-folded and pre-welded. Made of type E glass fibre reinforcement mesh, impregnated with SBR anti-alkaline resin, spacing 3.5 x 3.8 mm	Angular preformato tridimensional utilizzato para el refuerzo diagonal y de los ángulos interiores de intradoses de puertas y ventanas. Predoblado y presoldado. Realizada con malla de armadura en fibra de vidrio de tipo E, impregnada con resinas anti-alkalinas SBR, distancia entre centros 3,5 x 3,8 mm
Peso: 165 gr/m ² Misure: 20 x 30 cm altezza 10 cm 20 x 30 cm altezza 20 cm Confezione: 25 pezzi	Weight: 165 gr/m ² Size: 20 x 30 cm height 10 cm 20 x 30 cm height 20 cm Package: 25 pieces	Peso: 165 gr/m ² Medidas: 20 x 30 cm altura 10 cm 20 x 30 cm altura 20 cm Envase: 25 piezas

rete a fazzoletto per armatura spigoli finestre

	rete di armatura per angoli aperture con armatura diagonale	reinforcement mesh for corner openings with diagonal reinforcement	mallla de armadura para ángulos de aberturas con armadura diagonal
	<p>Angolare preformato utilizzato per l'esecuzione dell'armatura diagonale in corrispondenza degli angoli di aperture come finestre e porte. Utilizzata come rinforzo per disperdere le tensioni e prevenire così fenomeni fessurativi, garantendo la continuità dell'armatura del sistema cap-potto.</p> <p>Realizzato con rete di armatura in fibra di vetro di tipo E, impregnata con resine antialcaline SBR, interasse 3,5 x 3,8 mm</p>	<p>Shaped corner used for diagonal reinforcement of the corners of such openings as windows and doors. Used as a reinforcement to dissipate tensions and prevent cracking, thus guaranteeing continuity in the reinforcement of external thermal insulation systems.</p> <p>Made of type E glass fibre reinforcement mesh, impregnated with SBR anti-alkaline resin, spacing 3.5 x 3.8 mm</p>	<p>Angular preformado utilizado para la ejecución de la armadura diagonal coincidiendo con los ángulos de aberturas como ventanas y puertas. Utilizada como refuerzo para dispersar las tensiones y prevenir así fenómenos de fisuras, garantizando la continuidad de la armadura del sistema de aislamiento térmico. Realizada con mallla de armadura en fibra de vidrio de tipo E, impregnada con resinas antialcalinas SBR, distancia entre centros 3,5 x 3,8 mm</p>
	<p>Peso: 165 gr/m² Misure: 33,5 x 50 cm Confezione: 50 pz</p>	<p>Weight: 165 gr/m² Size: 33.5 x 50 cm Package: 50 pcs</p>	<p>Peso: 165 gr/m² Medidas: 33,5 x 50 cm Envase: 50 piezas</p>

finiture

topcoats

acabados

rivatone plus g15



scheda
tecnica



data
sheet



ficha
técnica

	rivestimento acrilico a spessore 1,5 mm	esterno	acrylic coating - 1.5 mm thick	outdoor	revestimiento acrílico de espesor 1,5 mm	exterior
	<p>Rivestimento a base di resine vinil-acriliche in dispersione, additivi atti a facilitare l'applicazione e la filmazione, graniglie di marmo e sabbie quarzifere ad assorbimento controllato grana max 1,5mm. Forma un film resistente all'attacco di alghe, funghi e muffe certificato dal Fraunhofer-Institut für Bauphysik di Monaco. Prodotto verificato secondo le norme UNI EN 15824 e ETAG n. 004 per l'uso del marchio CE. Uso ristretto agli operatori professionali.</p>		<p>Coating based on acrylic resins in dispersion. Contains additives that facilitate application and formation of a film as well as marble granules and quartz sand with controlled absorption, max particle size 1.5 mm. Forms a film resistant to algae, fungi, mould and mildew certified by the Fraunhofer-Institut für Bauphysik of Munich. Product tested according to UNI EN 15824 and ETAG no. 004 for use of CE marking. For strictly professional use.</p>		<p>Revestimiento a base de resinas vinilicas-acríticas en dispersión, aditivos con la función de facilitar la aplicación y la formación de película, granallas de mármol y arenas cuarcíferas de absorción controlada de grano máx 1,5 mm. Forma una película resistente al ataque de algas, hongos y mohos. Certificado por el Fraunhofer-Institut für Bauphysik de Munich. Producto verificado según las normas UNI EN 15824 y ETAG n.º 004 para el uso de la marca CE. Uso restringido a usuarios profesionales.</p>	
	<p>Granulometria: 1,5 mm Attrezzatura: frattazzo metallico, frattazzo di plastica Diluizione: pronto uso Resa (1 mano): 3 kg/m² - Per confezione (25 kg): 8,3 m²</p>		<p>Particle Size: 1,5 mm Equipment: metal trowel, plastic trowel Dilution: ready to use Coverage (1 coat): 3 kg/m² - Per pack (25 kg): 8.3 m²</p>		<p>Granulometría: 1,5 mm Herramientas: llana metálica, llana de plástico Dilución: listo para usar Rendimiento (1 capa): 3 kg/m² - Por envase (25 kg): 8,3 m²</p>	

tecniche



certificazioni



proprietà



tecnologie



rivatone plus g12



scheda
tecnica



data
sheet



ficha
técnica



rivestimento acrilico a spessore 1,2 mm	esterno	acrylic coating - 1.2 mm thick	outdoor	revestimiento acrílico de espesor 1,2 mm	exterior
Rivestimento a base di resine vinil-acriliche in dispersione, additivi atti a facilitare l'applicazione e la filmazione, graniglie di marmo e sabbie quarzifere ad assorbimento controllato grana max 1,2mm. Forma un film resistente all'attacco di alghe, funghi e muffe certificato dal Fraunhofer-Institut für Bauphysik di Monaco. Prodotto verificato secondo le norme UNI EN 15824 e ETAG n. 004 per l'uso del marchio CE. Uso ristretto agli operatori professionali.		Coating based on acrylic resins in dispersion. Contains additives that facilitate application and formation of a film as well as marble granules and quartz sand with controlled absorption, max particle size 1.2mm. Forms a film resistant to algae, fungi, mould and mildew certified by the Fraunhofer-Institut für Bauphysik of Munich. Product tested according to UNI EN 15824 and ETAG no. 004 for use of CE marking. For strictly professional use.		Revestimiento a base de resinas vinilicas-acríticas en dispersión, aditivos con la función de facilitar la aplicación y la formación de película, granallas de mármol y arenas cuarcíferas de absorción controlada de grano máx 1,2mm. Forma una película resistente al ataque de algas, hongos y mohos. Certificado por el Fraunhofer-Institut für Bauphysik de Munich. Producto verificado según las normas UNI EN 15824 y ETAG n.º 004 para el uso de la marca CE. Uso restringido a usuarios profesionales.	
Granulometria: 1,2 mm Attrezzatura: frattazzo metallico, frattazzo di plastica Diluizione: pronto uso Resa (1 mano): 2,2 kg/m ² Per confezione (25 kg): 11,5 m ²		Particle Size: 1,2 mm Equipment: metal trowel, plastic trowel Dilution: ready to use Coverage (1 coat): 2.2 kg/m ² Per pack (25 kg): 11.5 m ²		Granulometría: 1,2 mm Herramientas: llana metálica, llana de plástico Dilución: listo para usar Rendimiento (1 capa): 2,2 kg/m ² Por envase (25 kg): 11,5 m ²	

tecniche 	certificazioni 	proprietà 	tecnologie
---------------------------------	---	----------------------	-----------------------

rivatone idrosiliconico plus g15



scheda
tecnica



data
sheet



ficha
técnica



rivestimento metilsiliconico a spessore 1,5 mm	esterno	methylsilicone coating - 1.5 mm thick	outdoor	revestimiento metilsilicónico de 1,5 mm de espesor	exterior
Rivestimento fibrato ad effetto minerale compatto a base di resine metilsilossaniche, graniglie di quarzo e marmo grana max 1,5mm, additivi atti a facilitare l'applicazione e la filmazione, ad assorbimento controllato. Ottima idrorepellenza e traspirabilità. Forma un film resistente all'attacco di alghe, funghi e muffe, certificato dal Fraunhofer-Institut für Bauphysik di Monaco. Uso ristretto agli operatori professionali.		Fibre-reinforced coating with compact mineral-effect based on methylsiloxane resins, quartz and marble granules (max. particle size 1.5 mm) plus additives to facilitate application and formation of a film, with controlled absorption. Superb breathability and water-repellent properties. Forms a film resistant to algae, fungi, mould and mildew certified by the Fraunhofer-Institut für Bauphysik of Munich. For strictly professional use.		Revestimiento fibrado de efecto mineral compacto a base de resinas metilsiloxánicas, granallas de cuarzo y mármol, grano máx. 1,5 mm, aditivos para facilitar la aplicación y la formación de película, de absorción controlada. Excelente hidrorrepelencia y transpirabilidad. Forma una película resistente al ataque de algas, hongos y mohos, certificado por el Fraunhofer-Institut für Bauphysik de Munich. Uso restringido a usuarios profesionales.	
Granulometria: 1,5 mm Attrezzatura: frattazzo metallico, frattazzo di plastica Diluizione: pronto uso Resa (1 mano): 3 kg/m ² - Per confezione (25 kg): 8,3 m ²		Particle Size: 1,5 mm Equipment: metal trowel, plastic trowel Dilution: ready to use Coverage (1 coat): 3 kg/m ² - Per pack (25 kg): 8.3 m ²		Granulometría: 1,5 mm Herramientas: llana metálica, llana de plástico Dilución: listo para usar Rendimiento (1 capa): 3 kg/m ² - Por envase (25 kg): 8,3 m ²	

tecniche 	certificazioni 	proprietà 	tecnologie
---------------------------------	---	----------------------	---------------------------

rivatone idrosiliconico plus g12



scheda
tecnica



data
sheet



ficha
técnica



rivestimento metilsiliconico a spessore 1,2 mm	esterno	methylsilicone coating - 1.2 mm thick	outdoor	revestimiento metilsilicónico de 1,2 mm de espesor	exterior
<p>Rivestimento fibrato ad effetto minerale compatto a base di resine metilsilossaniche, graniglie di quarzo e marmo grana max 1,2mm, additivi atti a facilitare l'applicazione e la filmazione, ad assorbimento controllato. Ottima idrorepellenza e traspirabilità. Forma un film resistente all'attacco di alghe, funghi e muffe, certificato dal Fraunhofer-Institut für Bauphysik di Monaco. Uso ristretto agli operatori professionali.</p>		<p>Fibre-reinforced coating with compact mineral-effect based on methylsiloxane resins, quartz and marble granules (max. Particle Size: 1.2mm) plus additives to facilitate application and formation of a film, with controlled absorption. Superb breathability and water-repellent properties. Forms a film resistant to algae, fungi, mould and mildew certified by the Fraunhofer-Institut für Bauphysik of Munich. For strictly professional use.</p>		<p>Revestimiento fibrado de efecto mineral compacto a base de resinas metilsiloxánicas, granallas de cuarzo y mármol, grano máx. 1,2mm, aditivos para facilitar la aplicación y la formación de película, de absorción controlada. Excelente hidrorrepelencia y transpirabilidad. Forma una película resistente al ataque de algas, hongos y mohos, certificado por el Fraunhofer-Institut für Bauphysik de Munich. Uso restringido a usuarios profesionales.</p>	
<p>Granulometria: 1,2 mm Attrezzatura: frattazzo metallico, frattazzo di plastica Diluizione: pronto uso Resa (1 mano): 2,2 kg/m² - Per confezione (25 kg): 11,4 m²</p>		<p>Particle Size: 1,2 mm Equipment: metal trowel, plastic trowel Dilution: ready to use Coverage (1 coat): 2.2 kg/m² - Per pack (25 kg): 11.4 m²</p>		<p>Granulometría: 1,2 mm Herramientas: llana metálica, llana de plástico Dilución: listo para usar Rendimiento (1 capa): 2.2 kg/m² - Por envase (25 kg): 11,4 m²</p>	

tecniche

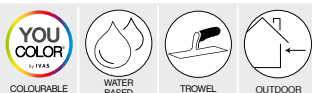

certificazioni



proprietà



tecnologie



rivatone plus trv g15



scheda
tecnica



data
sheet



ficha
técnica



rivestimento acrilsilossanico a spessore 1,5 mm	esterno	acrylic-siloxane coating - 1.5 mm thick	outdoor	revestimiento acrilsiloxánico de espesor 1,5 mm	exterior
<p>Rivestimento fibrato ad effetto compatto a base di resine acriliche e silossani idrofobizzati grana max 1,5mm indicato come finitura per i principali sistemi Termok8. A film protetto dall'attacco di alghe, muffe e microorganismi. certificato dal Fraunhofer-Institut für Bauphysik di Monaco. Prodotto verificato secondo le norme UNI EN 15824 e ETAG n. 004 per l'uso del marchio CE. Uso ristretto agli operatori professionali.</p>		<p>Fibre-reinforced coating with compact effect based on acrylic resins and water-repellent siloxanes with a maximum particle size of 1.5 mm, suitable as top coat for the main Termok8 systems. Forms a film resistant to algae, mould and microorganisms certified by the Fraunhofer-Institut für Bauphysik of Munich. Product tested according to UNI EN 15824 and ETAG no. 004 for use of CE marking. For strictly professional use.</p>		<p>Revestimiento fibrado de efecto compacto a base de resinas acrílicas y siloxanos hidrofobizados, grano máx. 1,5 mm indicado como acabado para los principales sistemas Termok8. Película protegida contra el ataque de algas, mohos y microorganismos. Certificado por el Fraunhofer-Institut für Bauphysik de Munich. Producto verificado según las normas UNI EN 15824 y ETAG n.º 004 para el uso de la marca CE. Uso restringido a usuarios profesionales.</p>	
<p>Granulometria: 1,5 mm Attrezzatura: frattazzo metallico, frattazzo di plastica Diluizione: pronto uso Resa (1 mano): 3 kg/m² - Per confezione (25 kg): 8,3 m²</p>		<p>Particle Size: 1,5 mm Equipment: metal trowel, plastic trowel Dilution: ready to use Coverage (1 coat): 3 kg/m² - Per pack (25 kg): 8.3 m²</p>		<p>Granulometría: 1,5 mm Herramientas: llana metálica, llana de plástico Dilución: listo para usar Rendimiento (1 capa): 3 kg/m² - Por envase (25 kg): 8,3 m²</p>	

tecniche



certificazioni



proprietà



tecnologie





rivestimento acriossilossanico a spessore 1,2 mm	esterno	acrylic-siloxane coating - 1.2 mm thick	outdoor	revestimiento acriossiloxánico de espesor 1,2 mm	exterior
Rivestimento fibrato ad effetto compatto a base di resine acriliche e silossani idrofobizzati grana max 1,2mm indicato come finitura per i principali sistemi Termok8. A film protetto dall'attacco di alghe, muffe e microorganismi. certificato dal Fraunhofer-Institut für Bauphysik di Monaco. Prodotto verificato secondo le norme UNI EN 15824 e ETAG n. 004 per l'uso del marchio CE. Uso ristretto agli operatori professionali.		Fibre-reinforced coating with compact effect based on acrylic resins and water-repellent siloxanes with a maximum particle size of 1.2mm, suitable as top coat for the main Termok8 systems. Forms a film resistant to algae, mould and microorganisms certified by the Fraunhofer-Institut für Bauphysik of Munich. Product tested according to UNI EN 15824 and ETAG no. 004 for use of CE marking. For strictly professional use.		Revestimiento fibrado de efecto compacto a base de resinas acrílicas y siloxanos hidrofobizados, grano máx. 1,2mm indicado como acabado para los principales sistemas Termok8. Película protegida contra el ataque de algas, mohos y microorganismos. Certificado por el Fraunhofer-Institut für Bauphysik de Munich. Producto verificado según las normas UNI EN 15824 y ETAG n.º 004 para el uso de la marca CE. Uso restringido a usuarios profesionales.	
Granulometria: 1,2 mm Attrezzatura: frattazzo metallico, frattazzo di plastica Diluizione: pronto uso Resa (1 mano): 2,2 kg/m ² - Per confezione (25 kg): 12 m ²		Particle Size: 1,2 mm Equipment: metal trowel, plastic trowel Dilution: ready to use Coverage (1 coat): 2,2 kg/m ² - Per pack (25 kg): 12 m ²		Granulometría: 1,2 mm Herramientas: llana metálica, llana de plástico Dilución: listo para usar Rendimiento (1 capa): 2,2 kg/m ² - Por envase (25 kg): 12 m ²	

tecniche 				certificazioni 				proprietà 		tecnologie 	
---------------------	--	--	--	---------------------------	--	--	--	----------------------	--	-----------------------	--



rivestimento acriossilossanico a spessore 1,0 mm	esterno	acrylic-siloxane coating - 1.0 mm thick	outdoor	revestimiento acriossiloxánico de espesor 1,0 mm	exterior
Rivestimento fibrato ad effetto compatto a base di resine acriliche e silossani idrofobizzati grana max 1mm indicato come finitura per i principali sistemi Termok8. A film protetto dall'attacco di alghe, muffe e microorganismi. certificato dal Fraunhofer-Institut für Bauphysik di Monaco. Prodotto verificato secondo le norme UNI EN 15824 e ETAG n. 004 per l'uso del marchio CE. Uso ristretto agli operatori professionali.		Fibre-reinforced coating with compact effect based on acrylic resins and water-repellent siloxanes with a maximum particle size of 1mm, suitable as top coat for the main Termok8 systems. Forms a film resistant to algae, mould and microorganisms certified by the Fraunhofer-Institut für Bauphysik of Munich. Product tested according to UNI EN 15824 and ETAG no. 004 for use of CE marking. For strictly professional use.		Revestimiento fibrado de efecto compacto a base de resinas acrílicas y siloxanos hidrofobizados, grano máx. 1mm indicado como acabado para los principales sistemas Termok8. Película protegida contra el ataque de algas, mohos y microorganismos. Certificado por el Fraunhofer-Institut für Bauphysik de Munich. Producto verificado según las normas UNI EN 15824 y ETAG n.º 004 para el uso de la marca CE. Uso restringido a usuarios profesionales.	
Granulometria: 1,0 mm Attrezzatura: frattazzo metallico, frattazzo di plastica Diluizione: pronto uso Resa (1 mano): 1,8 kg/m ² Per confezione (25 kg): 13,9 m ²		Particle Size: 1,0 mm Equipment: metal trowel, plastic trowel Dilution: ready to use Coverage (1 coat): 1,8 kg/m ² - Per pack (25 kg): 13,9 m ²		Granulometría: 1,0 mm Herramientas: llana metálica, llana de plástico Dilución: listo para usar Rendimiento (1 capa): 1,8 kg/m ² Por envase (25 kg): 13,9 m ²	

tecniche 				certificazioni 		proprietà 		tecnologie 	
---------------------	--	--	--	---------------------------	--	----------------------	--	-----------------------	--

rivatone plus reflect g15



scheda
tecnica



data
sheet



ficha
técnica



rivestimento a spessore riflettente a grana 1,5mm	esterno	thick reflective coating - particle size 1.5 mm	outdoor	revestimiento de espesor reflectante de grano 1,5 mm	exterior
La sua formulazione a base di resine acriliche e graniglie max 1,5mm prevede l'uso di pigmenti "freddi" idonei a riflettere la luce nello spettro IR. Permette di realizzare finiture scure, anche nere, su cappotto termico limitando il riscaldamento eccessivo della superficie. Prodotto verificato secondo le norme UNI EN 15824 per l'uso del marchio CE. Uso ristretto agli operatori professionali.		Its formulation based on acrylic resins and granules of max 1.5 mm involves the use of "cold" pigments able to reflect the light in the IR spectrum. Makes it possible to create dark, even black, topcoats on thermal insulation systems, limiting excessive heating of the surface. Product tested according to UNI EN 15824 for use of CE marking. For strictly professional use.		Su formulación a base de resinas acrílicas y granallas máx. 1,5 mm incluye pigmentos "fríos" idóneos para reflejar la luz de espectro IR. Permite realizar acabados oscuros, incluso negros, sobre sistema de aislamiento térmico limitando el calentamiento excesivo de la superficie. Producto verificado según las normas UNI EN 15824 para el uso de la marca CE. Uso restringido a usuarios profesionales.	
Granulometria: 1,5 mm Attrezzatura: frattazzo metallico, frattazzo di plastica Diluizione: pronto uso Resa (1 mano): 3 kg/m ² - Per confezione (25 kg): 8,3 m ²		Particle Size: 1,5 mm Equipment: metal trowel, plastic trowel Dilution: ready to use Coverage (1 coat): 3 kg/m ² - Per pack (25 kg): 8.3 m ²		Granulometría: 1,5 mm Herramientas: llana metálica, llana de plástico Dilución: listo para usar Rendimiento (1 capa): 3 kg/m ² Por envase (25 kg): 8,3 m ²	

tecniche	certificazioni	proprietà	tecnologie
WATER BASED TROWEL READY TO USE OUTDOOR	BBA CE EN 15824 ETA BREATHABLE	BREATHABLE	reflect plus

rivatone plus reflect g12



scheda
tecnica



data
sheet



ficha
técnica



rivestimento a spessore riflettente a grana 1,2mm	esterno	thick reflective coating - particle size 1.2mm	outdoor	revestimiento de espesor reflectante de grano 1,2mm	exterior
La sua formulazione a base di resine acriliche e graniglie max 1,2mm prevede l'uso di pigmenti "freddi" idonei a riflettere la luce nello spettro IR. Permette di realizzare finiture scure, anche nere, su cappotto termico limitando il riscaldamento eccessivo della superficie. Prodotto verificato secondo le norme UNI EN 15824 per l'uso del marchio CE. Uso ristretto agli operatori professionali.		Its formulation based on acrylic resins and granules of max 1.2mm involves the use of "cold" pigments able to reflect the light in the IR spectrum. Makes it possible to create dark, even black, topcoats on thermal insulation systems, limiting excessive heating of the surface. Product tested according to UNI EN 15824 for use of CE marking. For strictly professional use.		Su formulación a base de resinas acrílicas y granallas máx. 1,2mm incluye pigmentos "fríos" idóneos para reflejar la luz de espectro IR. Permite realizar acabados oscuros, incluso negros, sobre sistema de aislamiento térmico limitando el calentamiento excesivo de la superficie. Producto verificado según las normas UNI EN 15824 para el uso de la marca CE. Uso restringido a usuarios profesionales.	
Granulometria: 1,2 mm Attrezzatura: frattazzo metallico, frattazzo di plastica Diluizione: pronto uso Resa (1 mano): 2,2 kg/m ² - Per confezione (25 kg): 11,4 m ²		Particle Size: 1,2 mm Equipment: metal trowel, plastic trowel Dilution: ready to use Coverage (1 coat): 2.2 kg/m ² - Per pack (25 kg): 11.4 m ²		Granulometría: 1,2 mm Herramientas: llana metálica, llana de plástico Dilución: listo para usar Rendimiento (1 capa): 2,2 kg/m ² Por envase (25 kg): 11,4 m ²	

tecniche	certificazioni	proprietà	tecnologie
WATER BASED TROWEL READY TO USE OUTDOOR	BBA CE EN 15824 ETA BREATHABLE	BREATHABLE	reflect plus

rivatone plus strong g15



scheda
tecnica



data
sheet



ficha
técnica



rivestimento per tinte intense a grana 1,5mm	esterno	coating for intense colours - particle size 1.5mm	outdoor	revestimiento para tintes intensos de grano 1,5 mm	exterior
A base di resine acriliche in dispersione, additivi atti a facilitare l'applicazione e la filmazione, battericidi e fungicidi a vasto spettro d'azione, graniglie di marmo e sabbie quarzifere ad assorbimento controllato max 1,5mm. Permette di ottenere una vasta gamma di colori intensi e dal tono estremamente vivo minimizzando i rischi di decolorazione nel tempo. Prodotto verificato secondo le norme UNI EN 15824 per l'uso del marchio CE. Uso ristretto agli operatori professionali.		Based on acrylic resins in dispersion, contains additives to facilitate application and formation of a film. Contains broad spectrum bactericides, fungicides, marble granules and quartz sand with controlled absorption, max particle size 1.5 mm. Makes it possible to obtain a wide range of intense colours with vibrant tone, minimising the risk of discolouration over time. Product tested according to UNI EN 15824 for use of CE marking. For strictly professional use.		A base de resinas acrílicas en dispersión, aditivos con la función de facilitar la aplicación y la formación de película, bactericidas y fungicidas de amplio espectro de acción, granallas de mármol y arenas cuarcíferas de absorción controlada máx 1,5 mm. Permite obtener una amplia gama de colores intensos y de tono extremadamente vivo, minimizando los riesgos de decoloración en el tiempo. Producto verificado según las normas UNI EN 15824 para el uso de la marca CE. Uso restringido a usuarios profesionales.	
Granulometria: 1,5 mm Attrezzatura: frattazzo metallico, frattazzo di plastica Diluizione: pronto uso Resa (1 mano): 3 kg/m ² - Per confezione (25 kg): 8,3 m ²		Particle Size: 1,5 mm Equipment: metal trowel, plastic trowel Dilution: ready to use Coverage (1 coat): 3 kg/m ² - Per pack (25 kg): 8.3 m ²		Granulometría: 1,5 mm Herramientas: llana metálica, llana de plástico Dilución: listo para usar Rendimiento (1 capa): 3 kg/m ² - Por envase (25 kg): 8,3 m ²	

tecniche 	certificazioni 	proprietà 	tecnologie
---------------------	---------------------------	----------------------	-----------------------

rivatone plus strong g12



scheda
tecnica



data
sheet



ficha
técnica



rivestimento per tinte intense a grana 1,2mm	esterno	coating for intense colours - particle size 1.2mm	outdoor	revestimiento para tintes intensos de grano 1,2mm	exterior
A base di resine acriliche in dispersione, additivi atti a facilitare l'applicazione e la filmazione, battericidi e fungicidi a vasto spettro d'azione, graniglie di marmo e sabbie quarzifere ad assorbimento controllato max 1,2mm. Permette di ottenere una vasta gamma di colori intensi e dal tono estremamente vivo minimizzando i rischi di decolorazione nel tempo. Prodotto verificato secondo le norme UNI EN 15824 per l'uso del marchio CE. Uso ristretto agli operatori professionali.		Based on acrylic resins in dispersion, contains additives to facilitate application and formation of a film. Contains broad spectrum bactericides, fungicides, marble granules and quartz sand with controlled absorption, max particle size 1.2mm. Makes it possible to obtain a wide range of intense colours with vibrant tone, minimising the risk of discolouration over time. Product tested according to UNI EN 15824 for use of CE marking. For strictly professional use.		A base de resinas acrílicas en dispersión, aditivos con la función de facilitar la aplicación y la formación de película, bactericidas y fungicidas de amplio espectro de acción, granallas de mármol y arenas cuarcíferas de absorción controlada máx 1,2mm. Permite obtener una amplia gama de colores intensos y de tono extremadamente vivo, minimizando los riesgos de decoloración en el tiempo. Producto verificado según las normas UNI EN 15824 para el uso de la marca CE. Uso restringido a usuarios profesionales.	
Granulometria: 1,2 mm Attrezzatura: frattazzo metallico, frattazzo di plastica Diluizione: pronto uso Resa (1 mano): 2,2 kg/m ² - Per confezione (25 kg): 11,4 m ²		Particle Size: 1,2 mm Equipment: metal trowel, plastic trowel Dilution: ready to use Coverage (1 coat): 2.2 kg/m ² Per pack (25 kg): 11.4 m ²		Granulometría: 1,2 mm Herramientas: llana metálica, llana de plástico Dilución: listo para usar Rendimiento (1 capa): 2,2 kg/m ² - Por envase (25 kg): 11,4 m ²	

tecniche 	certificazioni 	proprietà 	tecnologie
---------------------	---------------------------	----------------------	-----------------------

rivatone clean plus g15



scheda
tecnica



data
sheet



ficha
técnica



rivestimento acrilsilossanico autopulente 1,5 mm	esterno	self-cleaning acrylic- siloxane coating - 1.5 mm	outdoor	revestimiento acrilsiloxánico autolimpiador 1,5 mm	exterior
Rivestimento granulometria max 1,5mm estremamente bianco che unisce alla caratteristica di traspirabilità, conferita dalla componente silossanica, un effetto foto-catalitico ossidante in grado di decomporre le sostanze organiche che vengono a contatto con la superficie, il supporto rimarrà, di conseguenza, bianco come appena realizzato. Resistente all'attacco di alghe, funghi e muffe certificato dal Fraunhofer-Institut für Bauphysik di Monaco. Uso ristretto agli operatori professionali.		Extremely white coating (max. particle size: 1.5 mm) that combines the breathability characteristic of the siloxane component with an oxidative photocatalytic effect capable of decomposing the organic substances that come into contact with the surface, thus ensuring that the substrate will remain as white as when first applied. Resistance to algae, fungi, mould and mildew certified by the Fraunhofer-Institut für Bauphysik of Munich. For strictly professional use.		Revestimiento con granulometría máx.1,5 mm extremadamente blanco que une a la característica de transpirabilidad, proporcionada por el componente siloxánico, un efecto foto-catalítico oxidante capaz de descomponer las sustancias orgánicas que entran en contacto con la superficie; el soporte quedará, por consiguiente, blanco como recién hecho. Resistente al ataque de algas, hongos y mohos. Certificado por el Fraunhofer-Institut für Bauphysik de Munich. Uso restringido a usuarios profesionales.	
Granulometria: 1,5 mm Attrezzatura: frattazzo metallico, frattazzo di plastica Diluizione: pronto uso Resa (1 mano): 3 kg/m ² - Per confezione (25 kg): 8,3 m ²		Particle Size: 1,5 mm Equipment: metal trowel, plastic trowel Dilution: ready to use Coverage (1 coat): 3 kg/m ² - Per pack (25 kg): 8.3 m ²		Granulometría: 1,5 mm Herramientas: llana metálica, llana de plástico Dilución: listo para usar Rendimiento (1 capa): 3 kg/m ² Por envase (25 kg): 8,3 m ²	

tecniche 	certificazioni 	proprietà 	tecnologie
---------------------	---------------------------	----------------------	-----------------------

rivatone clean plus g12



scheda
tecnica



data
sheet



ficha
técnica



rivestimento acrilsilossanico autopulente 1,2 mm	esterno	self-cleaning acrylic- siloxane coating - 1.2 mm	outdoor	revestimiento acrilsiloxánico autolimpiador 1,2 mm	exterior
Rivestimento granulometria max 1,2mm estremamente bianco che unisce alla caratteristica di traspirabilità, conferita dalla componente silossanica, un effetto foto-catalitico ossidante in grado di decomporre le sostanze organiche che vengono a contatto con la superficie, il supporto rimarrà, di conseguenza, bianco come appena realizzato. Resistente all'attacco di alghe, funghi e muffe certificato dal Fraunhofer-Institut für Bauphysik di Monaco. Uso ristretto agli operatori professionali.		Extremely white coating (max. particle size: 1.2mm) that combines the breathability characteristic of the siloxane component with an oxidative photocatalytic effect capable of decomposing the organic substances that come into contact with the surface, thus ensuring that the substrate will remain as white as when first applied. Resistance to algae, fungi, mould and mildew certified by the Fraunhofer-Institut für Bauphysik of Munich. For strictly professional use.		Revestimiento con granulometría máx 1,2 m extremadamente blanco que une a la característica de transpirabilidad, proporcionada por el componente siloxánico, un efecto foto-catalítico oxidante capaz de descomponer las sustancias orgánicas que entran en contacto con la superficie; el soporte quedará, por consiguiente, blanco como recién hecho. Resistente al ataque de algas, hongos y mohos. Certificado por el Fraunhofer-Institut für Bauphysik de Munich. Uso restringido a usuarios profesionales.	
Granulometria: 1,2 mm Attrezzatura: frattazzo metallico, frattazzo di plastica Diluizione: pronto uso Resa (1 mano): 2,2 kg/m ² Per confezione (25 kg): 12,5 m ²		Particle Size: 1,2 mm Equipment: metal trowel, plastic trowel Dilution: ready to use Coverage (1 coat): 2,2 kg/m ² - Per pack (25 kg): 12.5 m ²		Granulometría: 1,2 mm Herramientas: llana metálica, llana de plástico Dilución: listo para usar Rendimiento (1 capa): 2,2 kg/m ² Por envase (25 kg): 12,5 m ²	

tecniche 	certificazioni 	proprietà 	tecnologie
---------------------	---------------------------	----------------------	-----------------------



rivestimento acrilossilossanico autopulente 1,0 mm	esterno	self-cleaning acrylic- siloxane coating - 1.0 mm	outdoor	revestimiento acrilossiloxánico autolimpiador 1,0 mm	exterior
Rivestimento granulometria max 1mm estremamente bianco che unisce alla caratteristica di traspirabilità, conferita dalla componente silossanica, un effetto foto-catalitico ossidante in grado di decomporre le sostanze organiche che vengono a contatto con la superficie, il supporto rimarrà, di conseguenza, bianco come appena realizzato. Resistente all'attacco di alghe, funghi e muffe certificato dal Fraunhofer-Institut für Bauphysik di Monaco. Uso ristretto agli operatori professionali.		Extremely white coating (max.particle size 1mm) that combines the breathability characteristic of the siloxane component with an oxidative photocatalytic effect capable of decomposing the organic substances that come into contact with the surface, thus ensuring that the substrate will remain as white as when first applied. Resistance to algae, fungi, mould and mildew certified by the Fraunhofer-Institut für Bauphysik of Munich. For strictly professional use.		Revestimiento con granulometría máx 1mm extremadamente blanco que une a la característica de transpirabilidad, proporcionada por el componente siloxánico, un efecto foto-catalítico oxidante capaz de descomponer las sustancias orgánicas que entran en contacto con la superficie; el soporte quedará, por consiguiente, blanco como recién hecho. Resistente al ataque de algas, hongos y mohos. Certificado por el Fraunhofer-Institut für Bauphysik de Munich. Uso restringido a usuarios profesionales.	
Granulometria: 1,0 mm Attrezzatura: frattazzo metallico, frattazzo di plastica Diluizione: pronto uso Resa (1 mano): 1,8 kg/m ² - Per confezione (25 kg): 13,9 m ²		Particle Size: 1,0 mm Equipment: metal trowel, plastic trowel Dilution: ready to use Coverage (1 coat): 1,8 kg/m ² - Per pack (25 kg): 13.9 m ²		Granulometría: 1,0 mm Herramientas: llana metálica, llana de plástico Dilución: listo para usar Rendimiento (1 capa): 1,8 kg/m ² - Por envase (25 kg): 13,9 m ²	

tecniche 	certificazioni 	proprietà 	tecnologie
---------------------	---------------------------	----------------------	-----------------------



fondo acrilossilossanico all'acqua pigmentato	esterno	water-based pigmented acrylic- siloxane base coat	outdoor	fondo acrilossiloxánico al agua pigmentado	exterior
Fondo intermedio coprente per rivestimento a cappotto specifico per successiva applicazione di rivestimenti colorati a spessore. La tecnologia PLUS garantisce la protezione del film dall'attacco di alghe, muffe e microorganismi. La Classe TVOC A+lo rende idoneo per ottemperare ai protocolli CAM,Leed Breeam. Uso ristretto agli operatori professionali.		Opaque intermediate base coat for external thermal insulation system specifically designed for subsequent application of thick coloured coatings. The PLUS technology ensures that the film is resistant to algae, mould and microorganisms. Classified TVOC A+, it complies with CAM, Leed Breeam protocols. For strictly professional use.		Fondo intermedio cubriente para revestimiento por capas específico para la posterior aplicación de revestimientos de color en espesor. La tecnología PLUS garantiza la protección de la película contra el ataque de algas, mohos y microorganismos. La Clase TVOC A+ la hace idónea para cumplir con los protocolos CAM, Leed y Breeam. Uso restringido a usuarios profesionales.	
Attrezzatura: pennello, rullo a pelo corto, airless Diluizione: acqua - 10-20% Resa (1 mano): 4-4,5 m ² /l - Per confezione (14 l): 63 m ²		Equipment: brush, short-haired roller, airless spraying equipment Dilution: water - 10-20% Coverage (1 coat): 4-4.5 m ² /l - Per pack (14 l): 63m ²		Herramientas: brocha, rodillo de pelo corto, pistola pulverizadora Dilución: agua - 10-20 % Rendimiento (1 capa): 4-4,5 m ² /l - Por envase (14 l): 63 m ²	

tecniche 	certificazioni 	proprietà	tecnologie
---------------------	---------------------------	------------------	-----------------------

listellotto buchtal

scheda
tecnicadata
sheetficha
técnica

listello in gres porcellanato estruso	strip in extruded porcelain stoneware	listón de gres porcelánico extrusionado
Linea Base Gold Line in grès	Gold Line basic line, stoneware	Línea Base Gold Line en gres
Per sistema Termok8: Modular D Dimensioni: 25 x 8,30 cm Confezione: 1 scatola = m ² 0,83	For system Termok8: Modular D Size: 25 x 8.30 cm Package: 1 box = 0.83 m ²	Para sistema Termok8: Modular D Medidas: 25 x 8,30 cm Envase: 1 caja = 0,83 m ²

listello facciavista



listello facciate estruso in cotto	extruded brick facades strip	tira de fachadas de ladrillo extrusionado
Listello estruso in cotto tipo Style Terremilia o tipo Fornace Fosdondo.	Extruded terracotta slip, such as Style Terremilia or Fornace Fosdondo.	Listel extruido en barro cocido tipo Style Terremilia o tipo Fornace Fosdondo.
Per sistema: Termok8 Modular Facciavista Dimensioni: 24,5 x 5,5 x 1,6 cm Confezione: 1 m ² = 60 pezzi	For system: Termok8 Modular Facciavista Size: 24.5 x 5.5 x 1.6 cm Package: 1 m ² = 60 pieces	Para sistema: Termok8 Modular Facciavista Medidas: 24,5 x 5,5 x 1,6 cm Envase: 1 m ² = 60 piezas
Versione angolare del Listello Facciavista.	Corner version of Facciavista slip.	Versión angular del listel Facciavista.
Dimensioni: 24,5 x 5,5 x 11,7 x 1,6 cm Confezione: 1 m = 15 pezzi	Size: 24.5 x 5.5 x 11.7 x 1.6 cm Package: 1 m = 15 pieces	Medidas: 24,5 x 5,5 x 11,7 x 1,6 cm Envase: 1 m = 15 piezas

listello a mano san marco



listello facciavista in cotto in pasta	exposed brick slat in pasta	tira expuesta en pasta cocida
Listello in cotto a mano San Marco.	San Marco handmade terracotta slip.	Listel en barro cocido a mano San Marco.
Per sistema: Termok8 Modular Facciavista Dimensioni: 25 x 5,5 x 2 cm Confezione: 1 m ² = 60 pezzi	For system: Termok8 Modular Facciavista Size: 25 x 5.5 x 2 cm Package: 1 m ² = 60 pieces	Para sistema: Termok8 Modular Facciavista Medidas: 25 x 5,5 x 2 cm Envase: 1 m ² = 60 piezas
Versione angolare del Listello a mano San Marco.	Corner version of San Marco handmade slip.	Versión angular del Listel a mano San Marco.
Dimensioni: 25 x 5,5 h x 12 x 2 cm Confezione: 1m = 15 pezzi	Size: 25 x 5.5 h x 12 x 2 cm Package: 1 m = 15 pieces	Medidas: 25 x 5,5 h x 12 x 2 cm Envase: 1m = 15 piezas

listello flex

scheda
tecnicadata
sheetficha
técnica

listello effetto facciavista a basso modulo elastico	exposed-effect strip with low modulus of elasticity	tira de efecto visto con bajo módulo de elasticidad
Per sistema: Termok8 Flex e Modular Flex L.R.	For system: Termok8 Flex and Modular Flex L.R.	Para sistema: Termok8 Flex y Modular Flex L.R.
Dimensioni: 24x 5,2 cm Colori Classici: Rosso Sahara - Rosso Toscana - bianco (per m. con fuga da 12 mm) Confezione: da 2 m ² inclusa fuga da 12 mm	Size: 24x 5.2 cm Classic Colours: Sahara Red - Tuscan Red - white (for 12 mm joint) Package: 2 m ² including 12 mm joint.	Medidas: 24x 5,2 cm Colores Clásicos: Rojo Sahara - Rojo Toscana - blanco (para m. con fuga de 12 mm) Envases: de 2 m ² incluida la junta de 12 mm
Angolari	Corner version	Angulares
Colori Classici: Rosso Sahara - Rosso Toscana - bianco (per m. con fuga da 12 mm) Confezione: da 1,5 m. inclusa fuga da 12 mm	Classic Colours: Sahara Red - Tuscan Red - white (for 12 mm joint) Package: 1,5 m including 12 mm joint.	Colores Clásicos: Rojo Sahara - Rojo Toscana - blanco (para m. con fuga de 12 mm) Envases: de 1,5 m. incluida fuga de 12 mm

decori e cornici

decorative pieces and cornices

decoraciones y cornisas

Elementi decorativi sagomati in EPS (a norma UNI EN 13163) prerasati con malte fibrate. Specifici per applicazioni esterne; sovraverniciabili. Oltre alle proposte standard, possono essere realizzati profili personalizzati nella forma e nelle dimensioni in funzione delle esigenze tecniche ed estetiche del progetto, garantendo la massima flessibilità di un sistema termok8 su misura.

Shaped, decorative elements in EPS (compliant with UNI EN 13163) preskimmed with fibrous mortar. Specific for external applications. They can be overpainted. Besides the standard products, profile size and shape can be customized to meet the technical and aesthetic requirements of the project, thus guaranteeing utmost flexibility for a custom termok8 system.

Elementos decorativos perfilados en EPS (conforme a la norma UNI EN 13163) con enrasado previo con morteros fibrados. Específicos para aplicaciones externas; admiten recubrimiento de pintura. Además de las propuestas estándar, pueden realizarse perfiles personalizados en la forma y en las Dimensiones en función de las necesidades técnicas y estéticas del proyecto, garantizando la máxima flexibilidad de un sistema termok8 a medida.

cornice sottogronda - under gutter cornice - cornisa bajo canaleta



marcapiano - string course - imposta



decoro lineare - linear decoration - decoración lineal



bugna - rusticated ashlar - almohadilla

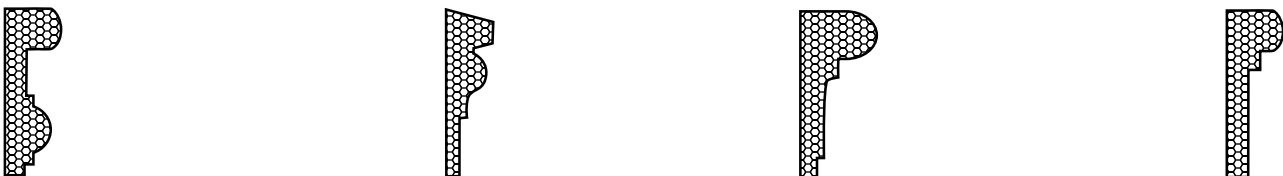

punta per trapano high speed



punta speciale per la foratura veloce e sicura di laterizi forati	special drill bit for fast, safe drilling of hollow brick	punta especial para perforación rápida y segura de ladrillos huecos
Punta per foratura veloce di laterizi forati. Permette una riduzione dei tempi di foratura e della forza impiegata. Migliora fino al 60% la resistenza alla trazione del tassello rispetto alla foratura con le normali punte.	Bit for fast drilling of hollow bricks. It reduces drilling time and force required. It improves anchor tensile strength by 60% over drilling with standard bits.	Punta para perforación rápida de ladrillos huecos. Permite una reducción de los tiempos de perforación y de la fuerza empleada. Mejora hasta el 60% la resistencia a la tracción del taco con respecto a la perforación con las puntas normales.
Eventuale confezione: 10 pezzi	Package: 10 pieces	Envase (en su caso): 10 piezas

fresa per risanamento STR



fresa per asportazione puntuale del rivestimento a spessore della rasatura armata	milling cutter for removal of thick reinforced skim coat	fresa para retirada puntual del revestimiento de espesor del enrasado armado
Fresa per il consolidamento di sistemi a cappotto esistenti. Pensata per asportare lo strato di finitura esterna e la rete di armatura permettendo di montare tasselli ad incasso o a percussione.	milling cutter for consolidation of existing external thermal insulation systems. Designed to remove the outer topcoat and reinforcement mesh, making it possible to install recessed or percussion anchors.	Fresa para consolidación de sistemas por capas existentes. Pensada para retirar la capa de acabado externo y la malla de armadura permitiendo montar tacos encajados o de percusión.

fresa per risanamento PTZ



fresa per asportazione puntuale del rivestimento a spessore	milling cutter for removal of thick coating	fresa para retirada puntual del revestimiento de espesor
Fresa per il consolidamento di sistemi a cappotto esistenti. Pensata per asportare solo lo strato di finitura esterna ed andare a tassellare il sistema attraverso la rete di armatura, sia con tasselli a percussione che ad avvitamento.	milling cutter for consolidation of existing external thermal insulation systems. Designed to remove only the outer topcoat and then anchor the system through the reinforcement mesh with either percussion or screw anchors.	Fresa para consolidación de sistemas por capas existentes. Pensada para retirar solo la capa de acabado externo para aplicar los tacos al sistema a través de la malla de armadura, con tacos que pueden ser de percusión o de rosca.
Fornita in un unico pezzo con testina di taglio già montata.	Supplied in one piece with cutting head already fitted.	Se entrega en una única pieza con cabezal de corte ya montado.

inserto per il montaggio CT 2G



bit specifico per il montaggio a filo esterno del tassello CT 2G	specific bit for flush surface mounting of the CT 2G anchor	punta bit specifica para el montaje al ras externo del taco CT 2G
Strumento specifico per applicazione sulla testa dell'avvitatore, dotato di vite Torx per l'applicazione dei tasselli CT 2G.	Tool designed for application on the screwer head, fit with a Torx screw for the application of CT 2G anchors.	Herramienta específica para aplicación en la cabeza del atornillador, dotado de tornillo Torx para la aplicación de los tacos CT 2G.
Lunghezza disponibile: 90 mm e 200mm Eventuale confezione: 10 pezzi	Available lengths: 90 mm and 200mm Package: 10 pieces	Largo disponible: 90 mm y 200 mm Envase (en su caso): 10 piezas

inserto per il montaggio CT L



bit specifico per il montaggio a filo esterno del tassello CT L	specific bit for flush surface mounting of the CT L anchor	punta bit específica para el montaje al ras externo del taco CT L
Strumento specifico per applicazione sulla testa dell'avvitatore, dotato di vite Torx per l'applicazione dei tasselli CT L.	Tool designed for application on the screwer head, fit with a Torx screw for the application of CT L anchors.	Herramienta específica para aplicación en la cabeza del destornillador, equipada con un tornillo Torx para la aplicación de los tacos CT L.
Lunghezza disponibile: 50 mm	Available lengths: 50 mm	Largo disponible: 50 mm

inserto per il montaggio CT S1



bit specifico per il montaggio a filo esterno del tassello CT S1	specific bit for flush surface mounting of the CT S1 anchor	punta bit específica para el montaje al ras externo del taco CT S1
Strumento specifico per applicazione sulla testa dell'avvitatore, dotato di vite Torx per l'applicazione dei tasselli CT S1.	Tool designed for application on the screwer head, fit with a Torx screw for the application of CT S1 anchors.	Herramienta específica para aplicación en la cabeza del atornillador, dotado de tornillo Torx para la aplicación de los tacos CT S1.

talpa per tassello CT 2G - CT L



talpa per tasselli CT 2G e CT L	circular drill bit for CT 2 G and CT L anchors	rosetta di fijación para tacos CT 2 G y CT L
Utensile specifico per il montaggio incassato dei tasselli CT 2 G e CT L.	Tool for perfect flush surface mounting of the CT 2 G and CT L anchor	Herramienta para un perfecto montaje al ras de los tacos CT 2 G y CT L
Kit costituito da: utensile, testine di taglio, avvitatore angolare, bits per l'avvitamento.	Kit consisting of: tool, cutting heads, angle screwdriver, bits for screwing.	Kit compuesto por: herramienta, cabezales de corte, destornillador angular, puntas para atornillar.

talpa per tassello CT S1



talpa per tasselli CT S1	circular drill bit for CT S1 anchors	rosetta di fijación para tacos CT S1
Utensile per un perfetto montaggio a filo del tassello CT S1	Tool for perfect flush mounting of the CT S1 anchors	Herramienta para un perfecto montaje enrasado del taco CT S1

kit ricambi per talpa - CT 2G e CT L



per talpa per tasselli CT 2G e CT L	for circular drill bit for CT 2G and ct l anchors	para rosetta di fijación para tacos CT 2G y CT L
Include 3 testine di taglio e 3 bits per l'avvitamento nel montaggio ad incasso.	Includes 3 cutting heads and 3 bits for screwing into recessed mounting.	Incluye 3 cabezales de corte y 3 puntas bit para atornillado en el montaje empotrado.

spatola sagomata



spatola speciale sagomata per rasature di fughe	special shaped spatula for skimming joints	espátula especial perfilada para enrasados de juntas
Spatolina opportunamente sagomata con specifici kit di accessori per la rasatura di fughe decorative eseguite con rete presagomata di tipo I (trapezio stretta), tipo II (trapezio larga) tipo III (triangolo).	Specially shaped spatula with kit of specific accessories for skimming decorative joints made with type I (trapezoidal - narrow), type II (trapezoidal - wide) and type III (triangular) shaped reinforcement mesh.	Espátula convenientemente perfilada con kit de accesorios específicos para el enrasado de juntas decorativas realizadas con malla previamente perfilada de tipo I (trapezio estrecha), tipo II (trapezio ancha) tipo III (triángulo).

tagliatrice per eps da ponteggio



taglierina a caldo per il taglio preciso di pannelli in eps	hot cutter for precise cutting of EPS panels	cizalla en caliente para el corte preciso de paneles en eps
Taglierina a caldo per il taglio professionale di pannelli isolanti in EPS. Il pannello di comando, comodo e maneggevole, assicura tagli rapidi, precisi e puliti. Staffe per tagliare orientabili per effettuare facilmente tagli obliqui. Ideale da utilizzare su impalcature. Utilizzabile anche come apparecchio da tavolo.	Hot cutter for professional cutting of EPS insulating panels. The convenient, easy-to-use control panel ensures rapid, clean precision cutting. Adjustable brackets make cutting on the diagonal easy. Ideal for use on scaffolding. Can also be used as a table unit.	Cizalla en caliente para el corte profesional de paneles aislantes en EPS. El panel de mando, cómodo y manejable, asegura cortes rápidos, precisos y limpios. Bidas de corte orientables para efectuar fácilmente cortes oblicuos. Ideal para su uso sobre andamio. Utilizable también como aparato de mesa.
Lunghezza massima: 105 cm, profondità massima 25 cm.	Maximum Length: 105 cm, maximum depth 25 cm.	Largo máxima: 105 cm, profundidad máxima 25 cm.





formazione Academy

IVAS investe da sempre energie e risorse in formazione, cultura e progettazione tecnica. Ogni anno vengono organizzati eventi, meeting e open day dedicati agli operatori del settore. Tra i temi al centro delle attività di formazione ci sono l'innovazione, il risparmio energetico, la cultura tecnica, la conoscenza applicativa, le tecnologie, i cicli tecnici. Nel 2008 Ivas ha creato, presso la propria sede, Gruppo Ivas Academy centro di formazione per professionisti che garantisce una formazione avanzata, dedicata, rigorosa ed esclusiva. Nel 2019 ha aggiornato la propria proposta formativa per rispondere alle esigenze di un mercato in continua evoluzione, secondo le nuove norme UNI, certificando nuove figure professionali. "La certificazione rappresenta garanzia di servizio qualificato e valore aggiunto per il professionista che vede riconosciuta la propria qualifica sul mercato con l'acquisizione di un patentino rilasciato da un Ente certificatore accreditato". Installatore di sistemi a cappotto, Installatore caposquadra, Pittore edile, Decoratore edile e Applicatore di resine. I corsi sono incentrati su approfondimenti teorici e intense attività pratiche che privilegiano aspetti centrali delle finiture in edilizia: cura dei particolari, soluzione di nodi critici, qualità del lavoro svolto, aggiornamento di normative tecniche e legislative, nuove proposte nel campo della decorazione. IVAS è certificata UNI EN ISO 9001 per la progettazione di attività formative professionali. "IVAS è una delle società fondatrici di CORTEXA, associazione che riunisce le più importanti aziende specializzate nel settore dell'isolamento Termico a Cappotto in Italia; inoltre è l'unico socio fondatore italiano dell'Associazione europea per l'ETICS (EAE), un consorzio creato per promuovere la cultura della sostenibilità nel settore delle costruzioni, migliorando l'efficienza energetica del patrimonio edilizio.

Gruppo Ivas Academy si trova presso la sede Gruppo Ivas, Via Bellaria, 40 - 47030 San Mauro Pascoli (FC)

PER INFORMAZIONI E DATE:
www.gruppoivas.com/academy.asp

assicurazione

Le richieste della clientela, sempre più attenta alla qualificazione dei propri edifici, unitamente alla serietà e affidabilità di termok8, hanno portato alla sottoscrizione con una delle più importanti compagnie assicurative di una polizza fiduciaria postuma.

La polizza assicurativa garantisce il ripristino delle parti danneggiate entro un periodo di 10 anni per cause imputabili a vizi di materiale o di sistemazione lavorativa.

Academy training

IVAS has consistently invested energy and resources in training, culture, and technical design. Every year events, meetings, and open days are organised for industry professionals. The topics focused on in the training activities include innovation, energy savings, technical culture, applied knowledge, technologies, and application processes. In 2008, IVAS opened Gruppo Ivas Academy at its headquarters, a training centre for professionals that guarantees advanced, dedicated, rigorous, and exclusive training. In 2019, it updated its training programme to meet the needs of a changing market, according to the new UNI standards, by certifying new job titles. Certification provides a guarantee of qualified service and added value for the professionals who see their qualifications recognised on the market with the acquisition of a licence issued by an accredited certification body: External thermal insulation system installer, foreman-installer, construction painter, construction decorator, and resin application technician. The courses are based on in-depth theoretical studies and intense practical activities that focus on key aspects of finishes in construction: attention to detail, resolving critical issues, quality of work performed, updating technical and legislative regulations, new proposals in the field of decoration. IVAS is UNI EN ISO 9001-certified for designing professional training activities. "IVAS is a founding member of CORTEXA, an association that brings together Italy's leading companies specialised in the External Thermal Insulation. Additionally, IVAS is the only Italian founding member of the European Association for ETICS (EAE), a consortium created to promote a culture of sustainability in the construction sector, enhancing the energy efficiency of the building stock".

Gruppo Ivas Academy is located at Gruppo IVAS's headquarters: Via Bellaria 40, 47030 San Mauro Pascoli (FC), Italy

FOR INFORMATION AND DATES:
<https://www.gruppoivas.com/en/academy.asp>

insurance

The demands of customers, who are increasingly attentive to the upgrading of their buildings, together with the high quality and reliability of termok8, have led to the stipulation of a post-completion insurance with a leading insurance company.

This insurance policy guarantees the repair or replacement of damaged parts for a period of 10 years due to defects in materials or workmanship.

formación Academy

IVAS ha investido constantemente en la educación, la cultura y el diseño técnico. Cada año se organizan eventos, reuniones y jornadas de puertas abiertas para profesionales del sector. La formación se centra en temas como la innovación, el ahorro energético, la cultura técnica y las tecnologías aplicadas. En 2008, Ivas fundó la Gruppo Ivas Academy, un centro de formación avanzada, dedicada, rigurosa y exclusiva. Desde 2019 actualiza continuamente su oferta para cumplir con las normas UNI, certificando a nuevos profesionales y garantizando un servicio de alta calidad. En 2019 ha actualizado su propia propuesta formativa para responder a las necesidades de un mercado en continua evolución, según las nuevas normas UNI, certificando nuevas figuras profesionales. La certificación representa una garantía de servicio cualificado y valor añadido para el profesional que ve reconocida su cualificación en el mercado al recibir una licencia emitida por el Organismo certificador acreditado: Instalador de sistemas por capas, Instalador jefe de equipo, Pintor de construcción, Decorador de construcción y Aplicador de resinas. Los cursos se centran en conocimientos teóricos y actividades prácticas intensas que favorecen a los aspectos centrales de los acabados del edificio: atención al detalle, solución de problemas críticos, calidad del trabajo, actualización de los reglamentos y leyes técnicas, nuevas propuestas en el campo de la decoración. IVAS es certificada UNI EN ISO 9001 para el diseño de actividades de formación profesional. "IVAS es una de las empresas fundadoras de CORTEXA, asociación que reúne a las principales empresas especializadas en aislamiento térmico por exterior de Italia. Además, es la única empresa italiana fundadora de la European Association for SATE (EAE), un consorcio creado para promover la cultura de la sostenibilidad en el sector de la construcción, mejorando la eficiencia energética del patrimonio edilicio.

Gruppo Ivas Academy se encuentra en la sede de Gruppo Ivas, Via Bellaria, 40 - 47030 San Mauro Pascoli (FC) Italia

PARA INFORMACIÓN Y FECHAS:
<https://www.gruppoivas.com/es/academy.asp>

seguro

Las exigencias de la clientela, cada vez más atenta a la calificación de sus propios edificios, junto a la seriedad y fiabilidad de termok8, han llevado a la suscripción con una de las compañías aseguradoras más importantes de una póliza fiduciaria postuma.

La póliza de seguros garantiza el restablecimiento de las partes que se hayan dañado en el plazo de 10 años por causas imputables a defectos de materiales o trabajo en obra.







termok8®

Scarica il database gratuito per il calcolo termico delle strutture opache.

Nel sito gruppooivas.com trovi la banca dati di tutti i prodotti e sistemi di isolamento termico termok8 di IVAS, utilizzabile nel software PAN di ANIT (Associazione Nazionale per l'isolamento Termico e Acustico). Lo strumento è realizzato per l'analisi termica, igrometrica e dinamica dell'involucro opaco e consente il calcolo della trasmittanza termica e la valutazione di molti altri indicatori prestazionali. Il software si basa in modo rigoroso sulla normativa tecnica vigente per l'analisi delle stratigrafie opache. Il progettista può eseguire una valutazione della qualificazione energetica dell'edificio ottenuta, applicando un isolamento a cappotto IVAS, identificando così la riduzione delle emissioni di CO₂, il consumo di combustibili ed il conseguente risparmio economico stimato.

Scopri l'intera gamma termok8 di IVAS, il primo produttore sul mercato italiano a proporre KIT di sistemi a cappotto autoprodotti a Km0, veramente sostenibili.

Download the Free Database for Thermal Calculation of Opaque Structures.

On the gruppooivas.com website, you can find the database of all termok8 thermal insulation products and systems (ETICS) by IVAS, which can be used in the PAN software by ANIT (National Association for Thermal and Acoustic Insulation). The tool is designed for thermal, hygrometric, and dynamic analysis of opaque envelopes and allows for the calculation of thermal transmittance and evaluation of many other performance indicators. The software strictly adheres to current technical regulations for the analysis of opaque stratifications. Designers and engineers can assess the energy qualification of a building obtained by applying IVAS external insulation, identifying the reduction in CO₂ emissions, fuel consumption, and the consequent estimated economic savings.

Discover the entire termok8 range by IVAS, the first producer in the Italian market to offer truly sustainable self-produced external thermal insulation systems (ETICS) at Km0.

Descargue la base de datos gratuita para el cálculo térmico de estructuras opacas.

En el sitio gruppooivas.com encontrarás la base de datos de todos los productos y sistemas de aislamiento térmico para exterior termok8 de IVAS, utilizables en el software PAN de ANIT (Asociación Nacional para el Aislamiento Térmico y Acústico). La herramienta está diseñada para el análisis térmico, higrométrico y dinámico de la envolvente opaca, permitiendo el cálculo de la transmitancia térmica y la evaluación de muchos otros indicadores de rendimiento. El software se basa rigurosamente en la normativa técnica vigente para el análisis de las estratigrafías opacas. Los diseñadores y los ingenieros pueden realizar una evaluación de la calificación energética del edificio obtenida al aplicar un aislamiento térmico para exterior de IVAS, identificando así la reducción de las emisiones de CO₂, el consumo de combustibles y el consiguiente ahorro económico estimado.

Descubres toda la gama termok8 de IVAS, el primer fabricante en el mercado italiano que ofrece KIT de sistemas de aislamiento térmico exterior autoproducidos a Km0, realmente sostenibles.



